

2244
DB3P7

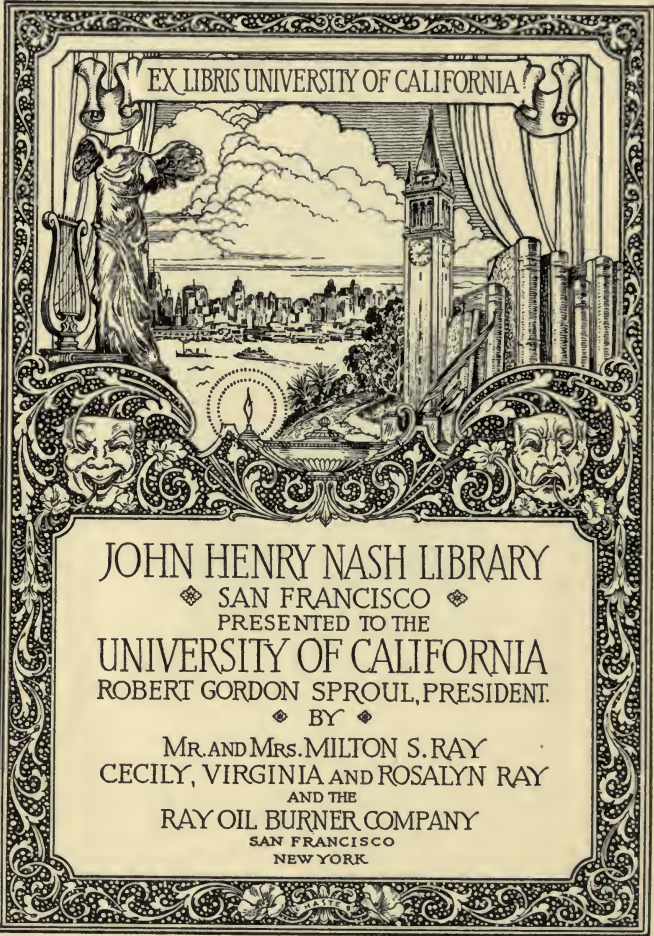

EX LIBRIS UNIVERSITY OF CALIFORNIA

JOHN HENRY NASH LIBRARY
◆ SAN FRANCISCO ◆
PRESENTED TO THE
UNIVERSITY OF CALIFORNIA
ROBERT GORDON SPROUL, PRESIDENT.
◆ BY ◆
MR. AND MRS. MILTON S. RAY
CECILY, VIRGINIA AND ROSALYN RAY
AND THE
RAY OIL BURNER COMPANY
SAN FRANCISCO
NEW YORK



MODERN METHODS OF
BOOK COMPOSITION



Digitized by the Internet Archive
in 2007 with funding from
Microsoft Corporation

THE PRACTICE OF TYPOGRAPHY

MODERN METHODS OF
BOOK COMPOSITION

A TREATISE ON
TYPE-SETTING BY HAND AND BY MACHINE
AND ON THE PROPER ARRANGEMENT
AND IMPOSITION OF PAGES

BY

THEODORE LOW DE VINNE, A.M.
"



NEW YORK
THE CENTURY CO.
1904

Copyright, 1904, by
THEODORE LOW DE VINNE

Published October, 1904

THE DE VINNE PRESS

CONTENTS

Chapter	Page
I EQUIPMENT.	1
Types . . . Stands . . . Cases . . . Case-racks.	
II EQUIPMENT.	39
Galleys and galley-racks . . . Compositors' implements Brass rules and cases for labor-saving rule and leads Dashes and braces . . . Leads . . . Furniture of wood and of metal . . . Furniture-racks . . . Quotations and electrotype guards.	
III COMPOSITION	75
Time-work and piece-work . . . Customary routine on book-work . . . Justification . . . Spacing and leading Distribution . . . Composition by hand and machine Proper methods of hand-work . . . Recent mannerisms.	
IV COMPOSITION OF BOOKS.	111
Title-page . . . Preface matter . . . Chapter headings and synopsis . . . Subheadings . . . Extracts . . . Notes and illustrations . . . Running titles and paging at head or at foot . . . Poetry . . . Appendix and index Initials . . . Head-bands, etc.	
V DIFFICULT COMPOSITION	171
Algebra . . . Tables and table-work . . . Music and music cases . . . Genealogies.	

Chapter	Page
VI FOREIGN LANGUAGES	231
Accents . . . Greek . . . Hebrew . . . German.	
VII MAKING UP	255
The running title . . . Signatures . . . Notes, tables, extracts, and illustrations.	
VIII STONE-WORK	289
Stones and chases . . . Exact adjustment of margins . . . Locking up . . . Taking proofs . . . Corrections . . . Clearing away.	
IX IMPOSITION.	331
Elementary principles . . . Schemes for various forms from two and four to one hundred and twenty-eight pages . . . Inset forms . . . Oblong pages . . . The leaf- let . . . Small pamphlets . . . New method of collating Folding-machines . . . Concluding remarks.	
X MACHINE-COMPOSITION	397
Review of early methods . . . General organization Assembling and keyboard mechanisms . . . Learning to operate . . . Management of the linotype machine Temperature of metal . . . Treatment of matrices and of space-bands . . . The melting-pot, mould, and disk The assembling elevator . . . Correct keyboard fin- gering.	

PREFACE

IN A BOOK previously published the literary side of type-setting was treated under the title of *Correct Composition*. This book, its intended supplement, will be confined to comments upon the mechanical methods of *Book Composition*.

In ordinary conversation this phrase is indiscriminatingly applied to composed types in small pages, whether plain or decorated, of four leaves or of forty volumes. So considered, the subject seems almost limitless. It must be evident that there are too many kinds of books and too many fashions in type-setting to be thoroughly described in an ordinary duodecimo.

The book composition here to be treated is that of the ordinary book of the established publisher—the plain book made to be used and read more than to be decorated and admired as an exhibit of typographical skill. As the plain book is always in most request, its construction should be the earlier study

of the young compositor, for whom this book has been prepared. To the buyer of a book who is also its reader, its value is in the importance, real or fancied, of its information. Next follows easily readable type, tastefully arranged in orderly pages with proper margins, clearly printed in strong black ink on appropriate but unpretentious paper. Engraved illustrations to explain the text, headbands and tail-pieces of harmonious design that close the staring gaps of chapter breaks and vary the monotony of print, here and there letters or lines in a bright red, are some of a few permissible attractions; but after all has been done by the type-founder, paper-maker, designer, and printer, the great value of the book is not in type or decoration, but in what the author has written.

Scant attention can be given to decoration. To describe with proper detail usual methods of workmanship in the decorated book or pamphlet that is now in favor would be a hopeless task. A thick volume of facsimiles printed in colors would be required for an instructive exhibit of medieval and modern styles of printing, but the book so prepared would be of small service to the young compositor. The decorated book is not a proper model for every-day service. It might be harmful, for it presents suggestions of styles

or methods that are impracticable in any printing-house with a scant supply of types or borders. Decoration is of doubtful value when it diverts the eye from matter to manner, from the thought of the writer to the skill of the printer. The unavoidably diminished performance of every experimental decorator with type, and the increased cost of his work, are other unpleasing consequences. No ornamental style now in vogue can be offered as one of permanent favor, for fashions in type-setting are as fickle as fashions in dress. To examine and compare the different styles of decorative composition that came in and went out of vogue during every ten years of the last century is to be forewarned that eccentricities of present popularity may be disliked in the near future.

It may be that in my explanations I have been more minute than is customary in manuals of printing. An expert compositor may smile at the frequency of suggestions that he does not need now, but there was a time when he did need them. Every master printer of experience will agree with me that the apprentice needs minute instruction, perhaps to reiteration, in the rudiments of printing. To space words evenly, to put proper blanks between lines of display, to make up matter in symmetrical pages and to impose them

for the convenience of pressmen and binders, may seem trifles to those compositors who rate speed higher than skill or good taste, but the remark of a great artist may here be repeated, Trifles make perfection, and perfection is not a trifle.

The equipment of a book-printing house with the new styles of cases and stands that are required in modern practice has received as much attention as space allows, but the list is incomplete, for new styles of merit are increasing in number. There is a demand in every printing-house for more compactness in the stowage of materials, with a proper provision for greater facility in their handling. As an aid to this object, suggestions have been made about new arrangements for leads, brass rules, furniture, and extra sorts of type.

There are chapters that claim the attention of a mature compositor. Every book-printing house is required at times to provide lines or paragraphs in the proper characters of foreign languages, or to set bars of music or formulas in algebra. To those who have little or no experience in the handling of the strange types required, the information here presented will be of service. In the compilation of this matter I have had many helpers, to whom I here renew acknowledgments and thanks.

Algebra, based upon an article in Lefevre's *Guide Pratique du Compositeur*, was revised and made clearer by Henry Burchard Fine, Ph.D., professor of mathematics at Princeton University.

Music was specially written for this work by Mr. James H. Martin of New York. His treatise on this subject will prove a thorough explanation of a much-neglected department of composition.

Greek has been revised by Benjamin E. Smith, L.H.D., editor of the *Century Dictionary*.

Hebrew has been corrected by Mr. Frank Horace Vizetelly, assistant editor of the *Jewish Encyclopedia*.

These departments of book composition are not common, but they are sure to appear occasionally in ordinary copy, and every compositor should be qualified to put them in type with a reasonable approach to correctness.

Machine-composition was written for this work by Mr. Philip T. Dodge, president of the Mergenthaler Linotype Company.

Correct Keyboard Fingering was contributed by Mr. John S. Thompson, instructor of the machine-composition branch of the Inland Printer Technical School, and author of a treatise of great value on *The Mechanism of the Linotype*.

MODERN METHODS OF
BOOK COMPOSITION



BENJAMIN FRANKLIN

I

EQUIPMENT

Types . . . Stands . . . Cases . . . Case-racks

TYPES



PRINTING-HOUSE that is fitted for the practice of one branch only of printing, as for law cases, weekly newspapers, or plain reprints, does not need a large variety of faces or sizes of type, but when it is intended that it shall be properly equipped for all kinds of book composition, large fonts of text types on the bodies of 12- 11- 10- 8- and 6-point are indispensable. Types on 9- and 7-point bodies, not often required, may be provided in smaller fonts. Types on smaller bodies and of still smaller fonts will be

needed for foot- and side-notes. The larger bodies of 14- 18- and 24-point will be useful for the texts of quartos and larger sizes, or as letter of display. To this assortment must be added small fonts of two-line capital letters for title-pages and plain initials varying in size from 8- to 72-point. There must be also types of bold face of many sizes, plain and condensed, for side- or subheadings; galleys, leads, brass rules, racks, stones, chases, wood and metal furniture, and many labor-saving devices.

Nor is this all. To meet the notions of different buyers, there should be at least one complete series of old-style type or some other variation from the standard of modern roman letter. The difficulty of providing for unforeseen requirements presents itself in another direction. It often happens that the largest fonts have been insufficiently provided with one or more characters. Books must be expected that will call for an increase in the supply of capitals, italics, figures, points, quadrats, etc. Foreign languages and scientific treatises will require accents and signs that are not supplied with the regular font of type. There is no book-house, however large or well equipped, that does not have to send to the type-foundries frequent orders for additions to large fonts, known as "sorts."

In every printing-house supposed to be amply equipped for miscellaneous book and pamphlet work, but a small portion of its types can be kept in daily use. Buyers' tastes are very capricious.

During one week nearly all the compositors may be setting 10-point old-style; in another week they will be setting 11-point modern. Material must be largely in excess of daily needs, and the master printer must be accustomed to have nine tenths or more of his type stand idle every day. It should be assumed at the outset that in a fully equipped book-house one thousand dollars' worth of printing-material in types, presses, and their appliances will be needed to keep each workman in reasonably steady employment. In the house that does one branch only of printing, the average will not be so high, but in large book-houses it often exceeds one thousand dollars. Yet the value of the types and their appliances handled daily by each piece-compositor rarely exceeds one hundred dollars. This is largely out of proportion to the sum invested, but the large investment is not to be evaded.

Composition can be economically done only when there are types enough to keep the compositors in steady employment.¹ It is possible, and sometimes it is unavoidable when a font too small has been

¹ A printing-house always does work to disadvantage when composition has to be suspended for want of type or sorts, but suspensions are frequent. There are many occasions for this suspension. Copy may be sent in irregularly, and in too small quantity. Proofs may be withheld by the author beyond the time agreed on. When returned, they may

be filled with additions and alterations that keep compositors at correction instead of composition. The return of forms from the press-room or foundry may be delayed by accident. When the font of type is small, any one of these hindrances will stop composition. Every contributor to the work should keep pace with his mates.

provided, to print a book from type not sufficient for a form of four or eight pages; but work so hampered is always done expensively, and is liable to peculiar faults. Every prosperous book-office has large fonts of the regular text types, varying in weight from two thousand to twenty thousand pounds.

The type required for a specified number of pages has been tabulated,¹ but the table makes no allowance for type that has to be kept standing by delays of author. To estimate the weight of the type required for a work, begin with a knowledge of the weight of the type set up in one day by the compositors employed on that work. Next estimate the time that may be taken between composition and the return of the type for distribution. This time will vary from two days to two months, for proofs sent abroad may be kept out much longer. The weight of the composed types that have to be kept idle, and that are unavailable for any other purpose, must be determined. Type enough must be provided to keep compositors employed for a specified number of days, but to make provision for unexpected hindrances, the supply required may be much greater than would seem necessary.

The most noticeable objects in a composing-room are not the types but the type cases, exposed breast-high. The stands that so uphold these cases are bulky and wasteful of floor-space, for cases in use

¹ See *Plain Printing Types*, p. 176.

should have abundant light, although the height of an upper case near a window often obstructs the lighting of other cases in the middle of the room. It follows that some compositors may have to work with insufficient light, too far apart, and without needed supervision or help from fellow-workmen. Italic, accents, or display letter that may be needed frequently, as well as the galley that receives composed type, are often at an inconvenient distance. Greater compactness is needed in cities where room rent and artificial lighting are serious expenses.

It is not a trivial task to keep materials accessible and in good order, but in no workshop does the rule, "A place for everything, and everything in its place," call for more rigorous enforcement than in the composing-room. To meet the conflicting requirements of closer compactness and of more space, some of the old and new forms of printing-house furniture call for more careful examination.

STANDS

The stand (or frame, as it is called in England) is an open framework of pine wood made to support the cases of type. The cross-pieces at the top that connect the front with the back are at different inclinations, so that the lower case may be at a low and the upper case at a higher angle. So placed, the compositor can see and reach all the characters exposed in the two cases.

Stands are made of two sizes, and are known as double and single. The dimensions of the double stand, which exposes four cases, are: length, 4 feet 6 inches; width, 1 foot 10 inches; height at back, 4 feet 6 inches; height in front, 3 feet 6 inches. The single stand that exposes two cases only, about one half the length of the double, is not so common.

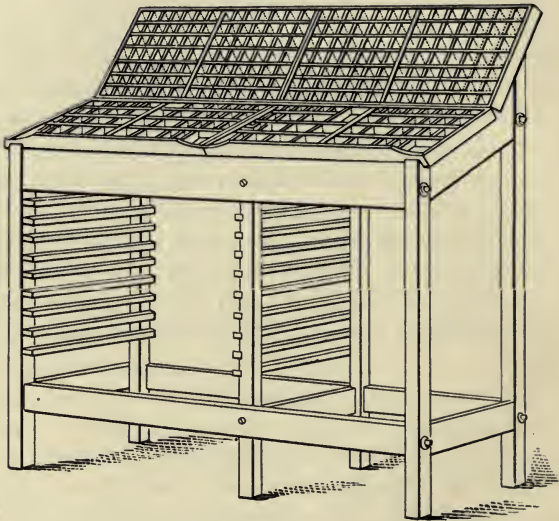

Double stand of usual form, containing rack for cases.¹

¹To break the habit of resting the feet on the lower cross-piece of the stand, and to prevent the accumulation of pi or dust on the floor, some daily newspaper

houses have the cases rest on strong iron bars that project from the side-walls. Stands are also made of iron pipe, but they are most used in news-houses.

Double stands are oftenest arranged back to back between windows, so that four compositors can work in the alley so made. As the ordinary stand has no provision for a galley, compositors have to empty their sticks on galleys at an inconvenient distance. It is often without a drawer for the safe-keeping of copy and cuts. It accommodates in an interior rack, but with some inconvenience to the compositor, six or eight cases on one side of the frame, but leaves unoccupied a large space on the other side, and a broad vacancy under the projecting upper cases at the top. This upward projection at the back seriously obstructs the light of those who work at a distance. Stands have been made low enough for the compositor to work seated, but they are not liked: nearly all compositors prefer to stand at work.

Double stands are also made with a support for a galley that can be placed inclined upright between the two exposed lower cases. This stand, more than five feet wide, allows the space below to be utilized for the stowage of two tiers of cases. A more useful form provides for an inclined galley-ledge in a sliding drawer (which also serves for copy out of use), so that the galley can be drawn out and put back without risk of piling the composition.

A much-approved departure from the old form is known as the Polhemus double stand,¹ which was constructed with an intent to have the back as

¹ Designed by John Polhemus, New York, 1872.

accessible as the front. Two compositors only can work in the alley so reduced. The exposed cases, supported by iron brackets, are placed on the top of a broad cabinet rack that contains thirty-six cases, a broad standing galley, and a galley-closet for

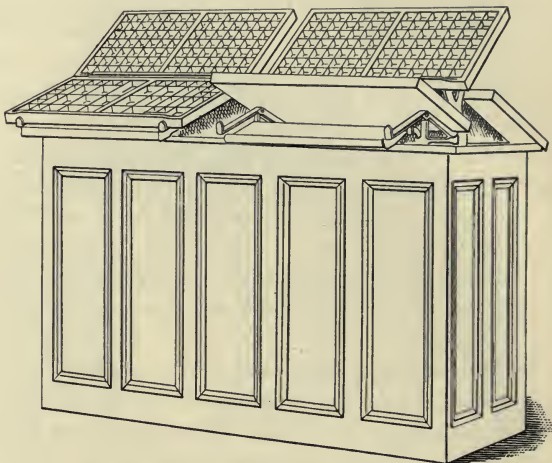

Polhemus double stand, panelled.

Front view of a panelled stand with galley-support and cases at the back. The lower cases rest on angled supports that allow these cases to be inclined backward.

movable galleys, but the last-named cases and galleys are at the back and not at the front of the workmen. The two compositors who work side by side can empty their composed type on the galley behind them, which is equally serviceable for

correction or storage of distributable type. Nor will they be disturbed at work if a third compositor should withdraw a case from the rack.

In printing-houses recently equipped, cabinets with case-upholding brackets of an improved form are preferred for their greater compactness and

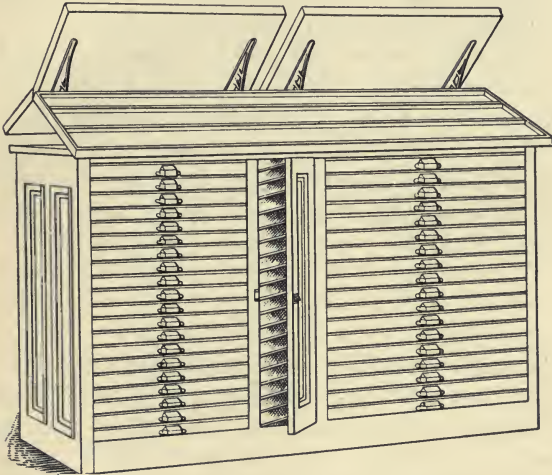

Rear view of the Polhemus double stand.

cleanliness. In the old-fashioned double stand the few cases in its rack below were widely separated and unavoidably received daily deposits of dust and paper rubbish. The old cases were held in their racks by supports of wood that suffered wear from continued rubbing. In all modern type cabinets of

improved construction, steel runs fastened to the side of the frame with countersunk screws are better substitutes for runways of wood, for they enable the cases to slide with more ease and lessen their wear. The steel runs have the greater advantage of enabling the maker-up to put cases closer together. Some forms of cabinets of double size will hold forty cases in their type-racks.

Another form of case-rest is designed to enable two compositors to work facing each other, over a cabinet rack that holds eighteen air-tight cases. It is planned to be placed in front of a window. As with the Polhemus stand, a third compositor can have unobstructed access to ten cases underneath while the two compositors are at work.

CASES

The cases on top of the cabinet that serves as a stand are held in proper angle by iron brackets. One kind of iron bracket is constructed to swing on a proper rest, so that it can be tilted upward and enable the compositor to empty his composed type on the galley underneath his case, or to make use of the top of the cabinet for the safe-keeping of copy out of use.

The case provided for ordinary composition is a shallow tray of wood $16\frac{3}{4}$ inches wide, $32\frac{1}{4}$ inches long, and 1 inch deep, divided by thin wood partitions into separate compartments, or boxes, as

called by compositors, so that there shall be a box for every character of the font. For the composition of ordinary copy in roman type are needed two

*	†	‡	§		¶	↵	lb	℥	@	%	‰	/	°
$\frac{1}{4}$	$\frac{1}{2}$	$\frac{3}{4}$	$\frac{1}{8}$	$\frac{3}{8}$	$\frac{5}{8}$	$\frac{7}{8}$	\$	£	~	~	~	~	~
$\frac{1}{3}$	$\frac{2}{3}$	&	Æ	Œ	æ	œ	-	-	—	—	&	Æ	Œ
A	B	C	D	E	F	G	A	B	C	D	E	F	G
H	I	K	L	M	N	O	H	I	K	L	M	N	O
P	Q	R	S	T	V	W	P	Q	R	S	T	V	W
X	Y	Z	J	U	[)	X	Y	Z	J	U		ff

Upper case, usual arrangement.

cases, respectively known as the upper and the lower case, so called from the positions they have on the stand. The upper case has ninety-eight boxes, which contain capitals, small capitals, and minor sorts that are seldom used ; the lower case has fifty-four boxes, which contain the lower-case characters, figures, points, spaces, and quadrats.

The arrangement of the characters in the upper boxes of the upper case, as shown in this diagram, is not uniform in every city, or even in every house. Some houses adhere to an old fashion of putting the large capitals on the left side, but the greatest irregularity is in the freakish placing of fractions, reference-marks, braces, and dashes, that are transposed by the chance piece-compositor to suit his

12 *The upper case has too many boxes*

own notion of convenience. A strange compositor who begins to work on a case that has been laid or altered by a new scheme has to relearn the loca-

ff	fl	□	□	'	k		1	2	3	4	5	6	7	8
j	b	c	d	e			i	l	f	g		ff	9	
?												fi	0	
!	l	m	n	h			o	y	p	w	,	□	□	
z														
x	v	u	t	□			a	r		;	:			
q										.	-			

Lower case, usual arrangement.

tion of the minor sorts. As these sorts are rarely used and are out of easy reach and inspection, he learns the new locations imperfectly and distributes incorrectly. In many offices the three upper rows of the upper case are nests of dust and pi.

It would be of mutual advantage to compositor and employer if these three upper rows were abolished, and the sorts assigned to them were kept in a separate case, as is done with accents and signs. Book copy rarely calls for any of these sorts. The reference-marks have been supplanted by superior figures, and the sectional braces by solid braces. Fractions are rarely needed, not often enough to justify the space they take. If frequency of use could determine the admission of extra sorts in the

capital case, italic should have preference, but no compositor of experience would favor this arrangement. The inconvenience suffered in seeking italic, fractions, or signs from a distant case is not so great as that endured in looking for misplaced sorts in dusty and inconvenient boxes. If the lower case were made longer, wider, and not so high, then the capitals and small capitals could be put therein and be brought within easier reach. Not the least of the advantages to be gained by the use of one case only would be the increased diffusion of light in the darker parts of a composing-room.

The only practical case now made to remedy this old mistake is the "patent hinged case"—so called because the upper case contains but five long tiers of boxes, instead of seven as is customary. The suppression of these two upper tiers shortens its height, and favors the increased diffusion of light. The two cases so connected by the hinge can slide on the same cleat in the ordinary case-rack.

Any unusual sort needed in composition can be put in a small annex box of tinned iron, which may easily be attached to any large box, and as readily be removed.

The boxes of an ordinary upper case and lower case are supposed to be arranged so that the sorts most used shall be nearest to, and those least used farthest from, the reach of the compositor. It is also supposed that the unequal sizes of the boxes are in proportion to the unequal use of the characters

14 *Irregularities in the lay of the case*

they contain. These suppositions are not entirely correct. The boxes have been made of whole, half-, and quarter-size more to suit the convenience of a

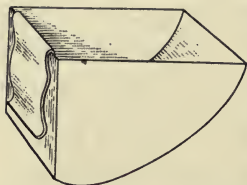

Annex box.

case-maker than to provide for the intelligent apportionment devised by typefounders. The most needed sorts are fairly placed, but the justifying spaces are scattered in very inconvenient positions.¹

The upper case and lower case, when put upon the stand, expose a surface of about seven square feet, which is too large a surface to be covered by the travel of the compositor's

¹ Illustrations of early composing-rooms show that the first printers tried to put all the types needed for the text in one large case. They laid the types in alphabetical order, beginning at the upper left-hand corner, and ever since we have adhered to one feature of this early usage. Our modern lower case has in the first row of large boxes the letters b, c, d, e, f, fi, ff, g. The second row has l, m, n, o, y, p; the third row has v, u, t, r. The types of a, i, s, h, w, r, seem to have been put out of the old order to bring them in easier reach. Printers of northern Europe, who use text types without small capitals, prefer a case in one piece, but in England and America the case in two parts

has always had most favor. The "lay" of the upper case has received many changes. In his *Mechanick Exercises* of 1683, Moxon presents an upper case with the large capitals in the upper left corner, and with figures in the lower left corner. It has no small capitals. The boxes that would otherwise be vacant are filled with signs. In his treatise of 1890 on *Printing*, Jacobi gives a diagram in which the capitals are put in the upper left corner. In his *Practical Printing* of 1892, Southward shows a model case with capitals at the right and small capitals at the left of the lower part of the upper case. In all the English schemes, figures are stowed in the upper case.

hand, for he who sets five thousand ems of solid type in one day has to make his hand travel about six or seven miles. The hand-travel in distribution is about one third more.

The more distant boxes on the left side of the ordinary upper case are nearly thirty inches from the stick in the hand of the compositor, and in a direction in which the right arm has not free play. To reach too distant boxes, the compositor of low stature has to move his feet, at some inconvenience and loss in performance.

A case that will shorten the travel of the hand should materially increase the performance of the compositor. With this end in view, a smaller case, known as the Rooker,¹ was introduced, which is about one fifth smaller than the ordinary case. It is used to some extent in daily newspaper offices, but is rarely found in book-houses. It holds letter enough for brevier and all smaller sizes, but not enough for a day's work with larger types.

The accepted form of lower case has many serious defects. Facilities for justification and even spacing have not been considered. The boxes for spaces are too far apart, when they should be clustered. Nor are the space boxes of proper size. In every font of letter the four-to-em spaces furnished are about the same weight as that of the letter *i*, yet *i* has a full box in easier reach, while the four-to-em space in a quarter-box is not so accessible.

¹ Invented by Thomas N. Rooker, of New York, about 1858.

The most needed three-to-em space is about of the same thickness as the lower-case *t*, but each sort occupies a box of the same size, although the type-founders furnish in weight one half more of the three-to-em space than of *t*. Nor are the boxes for other characters adapted to supply. Points like ; : ! ? and types of *j*, *X*, and *Z*, averaging about ten ounces each, have separate boxes as large as that given to the four-to-em space that is provided in a weight of nearly ten pounds. Some of the small boxes could be contracted without inconvenience, and the space saved be given to boxes that are now too small.

The difference between space required and space allowed for each sort will be more plain after a study of the scheme made by the Bruce Type Foundry¹ for a font of four hundred and twenty pounds:

<i>Lower-case sorts.</i>	<i>lb.</i>	<i>oz.</i>	<i>Italic.</i>	<i>lb.</i>	<i>oz.</i>
Lower-case letters	209	7	Lower-case letters	28	12
Points	11	8	Capitals	8	2
Figures, etc.	16	0			
Spaces ²	33	6	Roman accents	3	9
Quadrats	50	4	Italic accents	1	7
			Leaders	6	8
<i>Upper-case sorts.</i>					
Reference-marks	1	8	Total	<hr/> 420	
Braces	1	6			
Dashes	3	2			
Fractions	1	14			
Capitals	34	12			
Small capitals	7	10			

¹ The schemes of different type-founders are not exactly alike, but their trivial differences in apportionment will not mate-

rially disturb the percentages that have been specified in the table. Every new analysis will show decided inequality.

² The spaces and quadrats constitute more than one fourth of the weight of the lower-case sorts. The weight of the justifying spaces is about one sixth.

Analysis of a font of type 17

The proportion that each class of sorts bears to the entire weight of the font is shown in the following percentages :

Lower-case76	Italic09
Upper-case12	Accents, etc.03

As the weight of the upper-case sorts is but twelve per cent. of that of the complete font, and as its minor sorts are in small request, no great advantage could be had by altering the size of the boxes or by changing the location of their sorts. A readjustment of real value must be made in the lower case, which takes in seventy-six per cent. of the font.

<i>Large boxes.</i>	<i>Weight.</i>	<i>Capacity</i>	<i>Quarter-boxes.</i>	<i>Weight.</i>	<i>Capacity</i>
	<i>lb.</i>	<i>required.</i>		<i>lb.</i>	<i>required.</i>
	<i>oz.</i>			<i>oz.</i>	
c	7	2.20	space	9 4	2.91
u	8	2.36	space	4 10	1.46
d, i, r, m, each	10	3.15	-	2	.63
s	12	3.78	2	.63
space	18 8	5.83	;	1	.33
t	12 8	3.95	:	12	.24
h	13 4	4.12	'	12	.24
n	15 8	4.90	!	4	.06
o	15 8	4.90	?	4	.06
a	15 8	4.90	o	2	.63
quadrats } 37		11.64	i	2	.63
e	23 8	7.41	2	1 12	.55
			3, 4, 5, each	1 8	1.44
			6, 7, 8, 9 each	1 4	1.60
			q	1 8	.48
<i>Half-boxes.</i>			fi	1 8	.48
v	3	.95	k	1 8	.48
,	4	1.26	j	12	.24
b	4	1.26	x	12	.24
y, p, f, g, each	4 8	1.42	z	12	.24
l	5	1.57	ff	1	.33
█	5 4	1.65	ffi	1	.33
w	6 8	2.05	fl	12	.24
█	8	2.52			

18 *The case has many neglected boxes*

The lower case comprehends fourteen whole, eleven half- and twenty-eight quarter-boxes, and to them must be added the e box, which is always of largest size. The stowage capacity of each box, as compared with that of the entire lower case, is given in these percentages: whole box, 3.57+ ; half-box, 1.78+ ; quarter-box, 0.89+.

The boxes for c, u, d, i, m, r are too large ; those for h, t, n, o, and a are too small. The four-to-em spaces should have a box three times as large ; the five-to-em spaces, a box nearly twice as large.

For the half-boxes the want of proportion is not so marked. The v could be put in a smaller box ; b and , could have a box one fourth smaller ; the W and the en quadrat are the only sorts that call for a trifling enlargement of their boxes.

The preceding tables show that a simplification of the lower case is needed, and that the upper case is also in fault. Fractions, signs, and reference-marks, that rarely appear in book-work, have positions too prominent at the top of a case. It is to make room for these sorts that the case is made high and the lighting of a room is obstructed. Small capitals have been discarded in many books and newspapers. The only series in steady request are the capitals, but they could be attached to the lower case, as will be shown upon another page. Small capitals, signs, fractions, braces, and abbreviations could be relaid in the ordinary capital case, with other sorts in occasional request, and would be as

available in a rack under the compositor's stand. If his copy called for these sorts in excess, they would be as accessible there as they now are, out of easy reach. The lower case should have more room for spaces, and these spaces should be together. Points of punctuation and double letters should also be in groups. To save useless travel of the hand, and to make a more convenient lay of the sorts, this plan of a new lower case is offered :

A	B	C	D	E	F	G	H	I	J	K	L	M	N	O	P	Q
@	&	Æ	Œ	æ	œ			1	2	3	4	5	6	7	8	R
£	b	c	d	e				i	s	f	g	ff	9	S		
k												ff	0	T		
j	l	m	n	h				o	y	p	w	fi	fl	\$	U	
z												ff	'	-	V	
x	v	u	t	∅				∅	a	r	,)	[W		
q												!	?	X		
								∅		.	-	;	:	Z	Y	

Proposed arrangement of lower case with capitals.

The length of this proposed lower case is that of the old form, $32\frac{1}{4}$ inches, so that it can be stowed in the ordinary racks ; its width is one ninth greater, or about $18\frac{2}{3}$ inches. The addition of a tier of quarter-boxes at the side reduces the capacity of the full boxes about a quarter of an inch ; but they will be large enough for all bodies below 12-point.

If this form of case were in general use, the stand on which it rests would be narrower at least four inches, and the highest point of the case upon that stand would be about six inches lower than it is now, to the saving of space and the improvement of the lighting of the room.

This diagram is offered, not as a correctly apportioned case, but as an approximation that may lead to practical improvements hereafter. A case that exactly apportions the space for type would be too great and too expensive an innovation. The force of habit that has kept unchanged for three centuries the sizes and relative positions of the boxes for the leading sorts has to be respected. Changes have been proposed only where change seemed of real importance. Some boxes have been enlarged and others contracted, but there is no serious irregularity in the partitions that would increase the labor of case-making, and no changes in boxes that would make the case confusing to the compositor.

The greatest changes are where there is greatest need—in the sizes and positions of the space boxes. The weight of the en quadrat and the justifying spaces is more than one sixth the combined weight of all the lower-case sorts, but the room that is provided in the present form of case is only about one half of what is needed. The en quadrat is twelve inches distant in one direction and the four-and five-to-em spaces ten inches distant in another from the composing-stick in the compositor's hand.

As justifying and even spacing take up nearly as much time as the picking up of type, it follows that the labor of reaching for spaces should be lessened, and that the spaces, which are repeatedly changed in justification and are more handled than any other sort, should be clustered near the compositor's stick. As the spaces are laid in the new schemes, the compositor can select the en quadrat for wide-ledged work, or the four-to-em space for solid work, with as much facility as he now selects the three-to-em space. Large boxes and a central position of the spaces will be other aids to cleaner distribution.

The two- and three-em quadrats are put to the left, but the new position will be found quite as convenient as the old one. Few sorts are more irregularly used than the large quadrats. They are often needed in open composition, but on ordinary plain descriptive matter they do not deserve the accessible position they now have.

The quarter-boxes for the capitals are one eighth smaller than those of the upper case, but they are more accessible at the ends of the lower case. The half-boxes and whole boxes are of the old capacity. This form of case should enable the compositor to increase his performance seven per cent.

To those who wish small capitals exposed, a new arrangement is offered in the diagram on the next page. This case is wider and longer ($24\frac{1}{2} \times 32\frac{1}{4}$ inches), but it will contain for each box as many types as can be put in the regular cases.

22 *A lower case with all the capitals*

For ordinary composition the old-fashioned stands and cases are sufficiently serviceable, but they are not helpful enough when the compositor has copy that calls for two or more sizes of roman and italic,

Z	Y	X	W	V	U	T	S	R	Q	P	Q	N	M	L	K	J	I		
A	Æ	Œ	Æ	Œ	æ	œ			1	2	3	4	5	6	7	8	A		
B	@							e					f	fi	g	9	B		
C	£	b	c		u				i		s			ff		0	C		
D	k													fi	fl	\$	D		
E	j	f	m		n			h	o	y	p	w		fl		&	E		
F	z															?	!	F	
G	x	v	u		c								c			,)	[G
H	q															:	'	H	
Z	Y	X	W	V	U	T	S	R	Q	P	O	N	M	L	K	J	I		

An arrangement of case for capitals and small capitals.

This case has one hundred and twenty-one boxes. To make these boxes of the usual size and in similar proportion the case should be 20 × 42 inches, obviously too large for convenient handling. To keep it of the regulation length of 32¼ inches, so that it could be put on the ordinary stand and in ordinary case-racks, it must be about one half wider, or 24½ × 32¼ inches.

or for accents or display letter. For every change of body or of face, for italic, display letter, or accents, the compositor has to leave his stand and set the type from a case at a distance.

To those who need many sorts in ready reach, an illustration is shown on following pages of a form of stand made for the composition of the Century dictionary. For this work the compositor needed twelve cases readily accessible :

Brevier, one upper case and one lower case.

Brevier italic, one capital case.

Accents for brevier, one capital case.

Brevier antique, for side-heads, one job case.

Nonpareil, one upper case and one lower case.

Nonpareil italic, one capital case.

Accents and signs for nonpareil, one capital case.

Nonpareil antique, for subheads, one job case.

Irregular sorts, two cases.

To save space and get the desired compactness, the Rooker case, of 14 × 28 inches, was selected as large enough for a day's work on the sizes of brevier and nonpareil. Two more Rooker cases at right angles were put on each side, tilted inward as shown in the diagrams. The compositor, who stands before these cases, can readily reach all the boxes of the four cases, except those at the extreme outermost corners. A long-armed compositor can reach all without swaying his body. The illustrations show the brevier upper and lower cases in the usual position (L and K in the diagram), with the accents to the extreme left (M) and the italic to the extreme right (I).

The framework of the stand below the extreme right and left is utilized by adding thereto racks

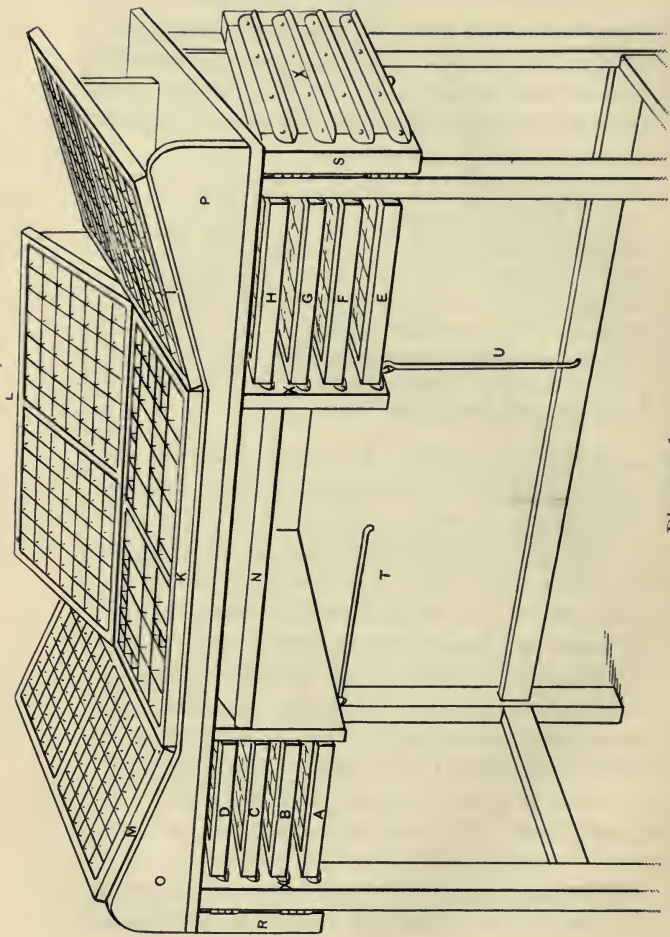

Diagram 1.

The De Vinne stand, with its under cases in rack and out of use.

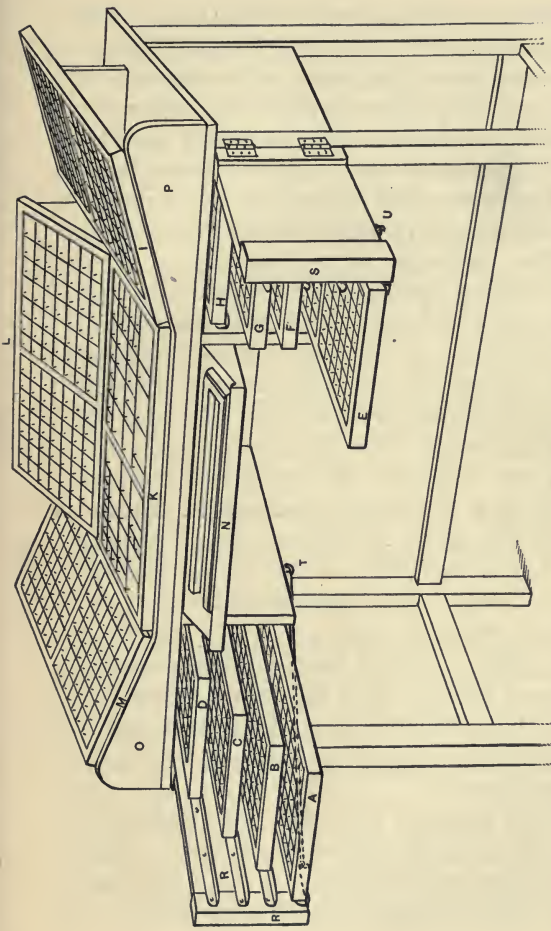

Diagram 2.

The De Vinne case, with swinging side-frames drawn out and locked, and with the galley exposed.

DIAGRAMS 1 AND 2. A and B, cases for extra and irregular sorts; C, nonpareil accents; D, nonpareil antique; E, brevier antique; F, nonpareil roman upper; G, nonpareil roman lower; H, nonpareil italic; I, brevier italic; K and L, brevier roman, upper and lower; M, brevier accents; N, drawer, containing galley; O and P, angled support for cases; R and S, swinging frame with racks; T and U, iron rods that hold the swinging side-frames.

with supports, so that cases least used can be put in sidewise, and yet be kept within easy reach. A swinging side-frame, firmly hinged, is attached on each side, and with supports parallel to those in the stand. These side-frames are kept firmly in position by the swinging iron bars T and U. When these bars are locked, the cases on each side can be drawn out at full length, exposing every box to view and touch. The compositor is in the centre of three sides of a small square, and can pick out any type he wants from about eight hundred boxes without leaving his frame, and for most of them without change of position. He can select accents, or words of italic or in display letter, without removing the case from its rack. When the lower cases in the side-racks are not needed, the swinging side-frame can be put back as shown in diagram 1. To prevent the cluttering up of other stands, and to save needless travel, the galley is put on an inclined plane in a drawer under the case in front of the compositor. When he wishes to empty composed matter on galley, he pulls out the drawer, unloads his stick, and then shoves in the drawer, where the galley interferes with no other composition, and is not so liable to accident as in the old position on an exposed stand.

Two of the job cases were made with capitals to the left, and two with capitals to the right. This keeps the most used division of the lower case nearest to reach on right- and left-hand sides.

The roman cases have the most needed spaces and en quadrats directly under the compositor's hand. This arrangement is made by putting the en-quadrat box next to the three-to-em-space box on the other side of the broad bar, and by putting the four- and five-to-em-space and hair-space boxes next to the three-to-em-space box. Not many other boxes have to be disturbed for their readjustment. This

z	j	?	!	,	k		1	2	3	4	5	6	7	8
x	b	c	d	e			i	s	f	g	fi	9		
q											ff	0		
v	l	m	n	h			o	y	p	w	y	;	:	
						
u	t						a	r						

Special lower case for dictionary.

clustering of the spaces saves time; it is an aid to exact work and is much approved by all compositors. These stands and cases cost but little more than those of the old form. They are as economical of space as they are helpful to compositors. Thirty compositors employed on one dictionary or book of like nature can work in better light, more pleasantly and efficiently, in a space of one thousand square feet than they could do in a space twice as large from many cases spread out after the old plan.

Small fonts of italic, or of display type that has no small capitals or minor sorts, are frequently placed in one case of a form known as the job case.

ff	fl	ll	'	k		1	2	3	4	5	6	7	8											
j	b	c	d	e		i	s	f	g	ff	9													
?										fi	0			\$	£		Æ	Œ	æ	œ				
!	l	m	n	h		o	y	p	w	,	□	□		A	B	C	D	E	F	G				
z														H	I	K	L	M	N	O				
x	v	u	t	□		a	r	;	:					P	Q	R	S	T	V	W				
q								.	-					X	Y	Z	J	U		&	ffl			

Job case of usual form.

To meet different needs, these job cases are made to many plans. One form holds capitals, small capitals, and lower-case; another has enlarged boxes for capitals and contracted boxes for lower-case;

ff	fl	ll	'	k		1	2	3	4	5	6	7	8	\$	£									ffl
j	b	c	d	e		i	s	f	g	ff	9			A	B	C	D	E	F	G				
?										fi	0													
!	l	m	n	h		o	y	p	w	,	□	□		H	I	K	L	M	N	O				
z																								
x	v	u	t	□		a	r	;	:					P	Q	R	S	T	V	W				
q								.	-					X	Y	Z	J	U	()	&			

Job case with enlarged boxes for capitals.

another has large square boxes for figures only, of the two faces needed in some table-work.

Petty fonts of display types on small bodies are seldom needed in the book-house, but they can be

The diagram shows a large rectangular frame divided into three vertical sections. The left and right sections consist of empty 5x7 grids. The middle section contains a 5x7 grid with the following content:

\$	£	Æ	Œ	æ	œ	
A	B	C	D	E	F	G
H	I	K	L	M	N	O
P	Q	R	S	T	V	W
X	Y	Z	J	U	&	

Triple case for capitals only.

compactly laid in the triple case, which will be of service also for the proper placing of accents, regular or unusual, astronomical and other signs, and minor sorts of all kinds. Every book-house needs a few vacant boxes for irregular sorts.

In one division of the triple case can be put the regular accents for roman capitals; in another, the accents for small capitals; and in the third division accents for lower-case types. For italic capital and lower-case accents another triple case should be provided. In all the cases the accents should be laid with system: the same vowel in boxes on a horizontal line, the same accents in boxes on a vertical line. A print of each accent pasted on its

30 *Accent cases for roman and italic*

proper box will be helpful to the new compositor, and a safeguard against reckless distribution. In

á	à	â	ä	ã	ā	ǎ	Á	À	Â	Ä	Ã	Á	À	Â	Ä	Ã
é	è	ê	ë				É	È	Ê	Ë		É	È	Ê	Ë	
í	ì	î	ï				Í	Ì	Î	Ï		Í	Ì	Î	Ï	
ó	ò	ô	ö	õ			Ó	Ò	Ô	Ö	Õ	Ó	Ò	Ô	Ö	Õ
ú	ù	û	ü				Ú	Ù	Û	Ü		Ú	Ù	Û	Ü	
é	è	ê	ë	ǎ	ā		Ç				Ñ	Ç				Ñ
ý			ÿ													

Accent case for roman.

the vacant boxes can be put peculiar accents not often needed, like the longs and shorts of school-books, and the marked vowels of Danish, Swedish, and other languages. The tendency of modern authorship is to insist on a nicer attention to accents.

Á	À	Â	Ä	Ã												
É	È	Ê	Ë			á	à	â	ä	ã						
Í	Ì	Î	Ï			é	è	ê	ë							
Ó	Ò	Ô	Ö	Õ		í	ì	î	ï							
Ú	Ù	Û	Ü			ó	ò	ô	ö	õ						
Ç				Ñ		ú	ù	û	ü							
						ç				ñ						

Accent case for italic.

Tray cases are now made to be used as nests for smaller cases of one-fourth size, which can be removed from the tray and be placed temporarily on the upper case or the imposing-stone. They are used for brass rule, but will be equally serviceable, when divided into proper compartments, for the signs of algebra and scientific work. Sections still smaller (5×8 and $7 \times 7\frac{1}{2}$ inches, outside) are furnished by foundry for leaders, electrotype guards, and the other characters occasionally needed.

A great defect in cases of old manufacture was the splitting or warping of wood that was not seasoned. Some modern cases have bottom pieces of three thin layers of glued wood that have been made one solid piece

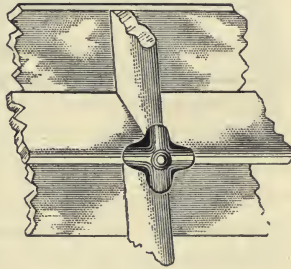

Box-fastener.

under strong pressure. The fibres of each layer cross proximate layers at an angle, thereby making an effective safeguard against warping or cracking. Other makers attach to side-frames or to cases a new form of runner that enables the case to slide easily in its rack and prevents needless friction and wear. The cases now made are as strong as they are light: the corners of the boxes are strengthened by a long pin and clamps of thin brass that securely bind the woodwork.

Large types and borders that cannot be properly stowed in the ordinary capital case are often needed in a book-house for the proper composition of title-pages and publishers' circulars. For this need a

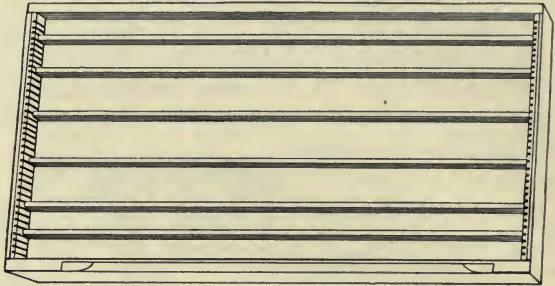

Tray case with movable partitions.

tray case is provided with movable partitions fitting into the slotted sides, that may be used with advantage for all sizes greater than 24-point.

The tray case without compartments or slotted sides is of service as a nest in holding the quarter or smaller sections containing brass rules, figures, leaders, quadrats, or any kind of sort used in excess that has to be carried to the compositor's case. The sections are divided in compartments of different sizes for the needs of special work.

Electrotyped illustrations that vary in size from an inch square to fifty square inches, often furnished in bewildering profusion, are difficult to keep in order ; nor are half-tone cuts easily identified when

they have been made accessible. A cabinet case for cuts, with index, is needed in all printing-houses.



A combination of quarter cases.

These cabinets are of full, three-quarter, and two-third sizes, and contain many air-tight tray cases. Each case has adjustable partitions that keep together cuts of the same class. It is also labelled with a number that refers to its written description in the index book furnished with the cabinet.¹

¹ An equally useful safeguard against confusion can be made by numbering, in consecutive order, each cut as soon as it is received, by proving it, and by pasting the proof with its number in regular order in a scrap-book. Very small cuts, less than one inch square, often made for dictionaries and the catalogues of manufacturers, can be stowed with safety and compactness in cardboard envelopes with box sides and of uniform size. When

each envelope has been filled, a proof of all the cuts therein should be pasted on the inside of its flap, and then the envelope can be marked in ink on the exposed side with the numbers of the pages from which the cuts have been taken — as, Dictionary, 17-32. So treated, they can be handled easily, piled one on top of another, or be laid in order in a tray case. They are protected from dust, and can be found without troublesome search.

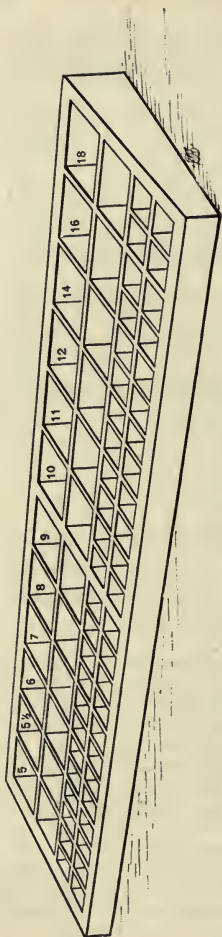

Case for quadrats and spaces of different bodies from 5-point to 18-point.

In all printing-houses it is a rule that spaces and quadrats must not be distributed in cabinet cases that hold petty fonts. The scattering of these sorts in many boxes, where they are found with difficulty, gives needless trouble. To prevent this annoyance, a form of quadrat case has been made to rest upon the top of the cabinet case or galley-rack. It is intended to contain the quadrats and spaces for all ordinary lines of display exposed in a position where justification is facilitated.

Other ingenious designs of cases are to be had. A lead case for 1- 2- 3- and 6-point bodies, for very short leads that cannot be stowed in the ordinary lead-rack, is a valuable addition to a printing-house that does algebraic work or other nice justification. The leads so cut can be well placed in a brass-rule case of four

sections. High and low leads and each thickness of lead should be kept apart in a separate section.

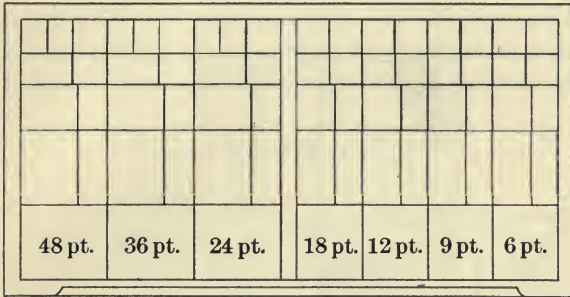

The common form of quadrat case.

To save floor-space, cases of half-, two-third, and three-quarter sizes are provided for job-printers, who need many small fonts of display type that are infrequently used. Job cases are made from many plans for capitals only, and for capital and lower-case letters combined, as in the regular job case of full size, and they are always fitted to accompanying racks that are usually known as cabinets. Petty cabinets are not desirable in a book-house. Cases of usual form that can be transferred from one rack to another, and that permit all similar styles of type to be grouped together, will be found of greater service.

The orderly arrangement of a composing-room is largely prevented by irregularities in the shape of its cases, stands, racks, stones, and closets that

cannot be combined or neatly fitted to one another. In the fitting up of a new office the stands, racks, and closets provided should be of the full size, half-size, or double size of the ordinary double frame, so that each piece of furniture can be readily fitted to another piece when any new arrangement is desired.

CASE-RACKS

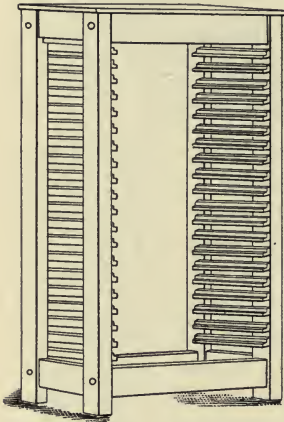

Case-rack of wood.

Case-racks are required for the stowage of cases not in frequent use. In all large printing-houses that keep in stock one thousand or more cases, the case-racks occupy too much room. Sometimes they are placed against a dead wall, and sometimes in the interior of a dark room. To economize a needed space, they are often made six, seven, or eight feet high. At these too high elevations

the case-rack obstructs light, and the cases are difficult to handle and are liable to be pied. It is better practice to limit their height to five feet.

The case-racks of display type should have side-frames, with supports that project about four or

more inches from the frame. This extension will enable the compositor to expose the case and set a line therefrom without removing it from the rack.

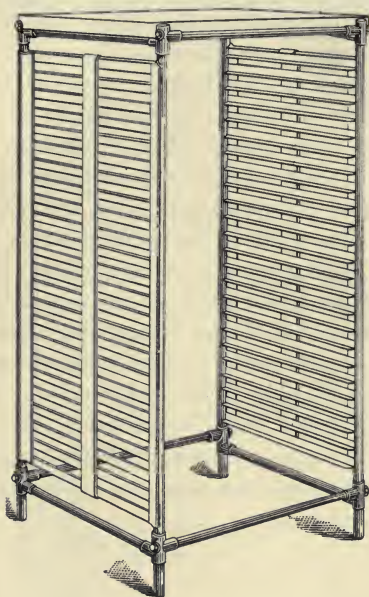

Case-rack of pipe-iron.

Each case should be numbered with a large readable figure, and the duplicate of this figure should be pasted on the side of the case-rack where the case belongs. This method will be a safeguard against misplacement, and of real service to the

composer who begins to select type or distribute in a strange printing-house.

Many of the cases here described are in common use, but other plans are required for peculiar work. For the cases needed in the composition of Greek, Hebrew, and music, see diagrams on later pages under these headings. Labor-saving brass rule, borders of brass rule for pages of different size, space rule, braces, dashes, leaders, figures, and short leads of different thicknesses need cases with unequal compartments, that are often made to order. The quarter case that nests in the tray case is the most generally useful form of small case, for it can be removed from its tray and placed within easy reach of the compositor without disturbing his work on the regular form of lower case. Small cases are also made to the sizes of $7\frac{3}{8} \times 15\frac{1}{4}$ and $7 \times 7\frac{1}{2}$ inches, with compartments of unequal space for the orderly keeping of short leads, leaders, and irregular sorts in occasional request.





ISAIAH THOMAS

II

EQUIPMENT

Galleys and galley-racks . . . Compositors' tools . . . Brass rules and cases for labor-saving rule . . . Dashes and braces
Leads . . . Furniture of wood and metal . . . Furniture-racks
Quotations . . . Electrotype guards

GALLEYS AND GALLEY-RACKS



THE galley is a tray of wood or brass with a raised rim on two or three sides, made to hold composed type, for which service it is kept in an inclined position. The galley of wood, which has its rim at the head and on one side only, is frail and seldom used. The galley of brass, with a rim at the head and on each side, is stronger and much more durable; it holds the type securely, and allows it to be locked up and proved on a press. Galleys are sometimes

entirely of brass, but they oftener have wood rims lined with brass. The length in common use is

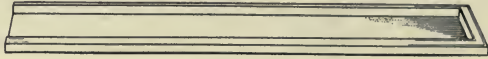

Single galley of brass.

twenty-four inches. If less than five inches wide it is known as a single galley; if over six inches wide, as a double galley; if short and wide it is

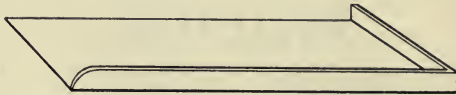

Galley of wood.

called a quarto galley. For making up and tying up pages a short galley of brass with a low rim is preferred. The slice galley, usually of quarto shape and of wood, has no attached rim to the slice or tray on which the type is placed. The rim is made by

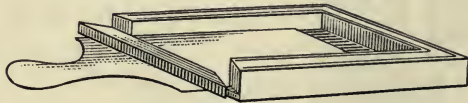

Slice galley, partly opened.

the sides of the open box in which the slice is kept. The slice has a handle at the narrow end, which enables it to be easily removed, with its tied-up type, from its box. The slice galley is preferred for the

making up of pages or jobs that are too large to be seized by the hands, but that can be launched on the stone after they have been tied up.

Galley-racks are temporary rests for the galleys while the type on them waits for the action of the

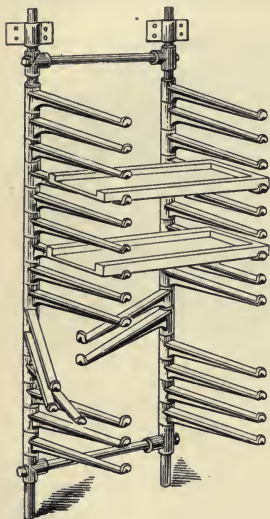

Galley-rack with swinging arms.

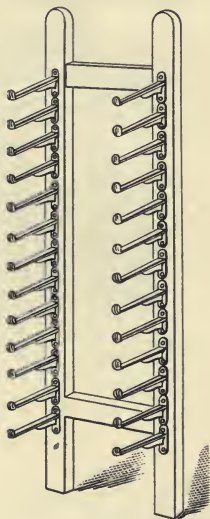

Galley-rack with fixed arms.

reader or maker-up. The form frequently used in a small office is a series of hanging arms attached to a dead wall. Sometimes the arms are of wood, sometimes of pipe-iron, or with joints, so that each arm can be folded back ; but all galley-racks of this

kind are wasteful of space, and invite the piling or squabbling of the type on the galley.

In all houses that have many galleys in regular use the form of galley-rack shown in the accompanying illustration is more satisfactory. It is a series of inclined shelves, that permit the galleys

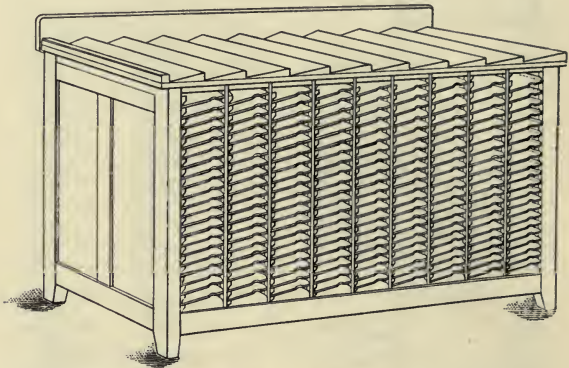

Shelf rack for galleys.

to be compactly stowed lengthwise, without risk of damage. When each galley is numbered, and a corresponding number is affixed to its shelf, and this number is marked on the proof, there need be no difficulty in finding any galley in a large rack.

The standing galley is an inclined tray, firmly attached to the top of a cabinet case or low case-rack, made with longitudinal divisions to the width of the measures in greatest use. It holds standing

matter that may be reimposed and used, or dead matter intended for distribution, and should be placed in a good light. The racks below this standing galley are often used for stowing letter-boards, upon which tied-up pages or jobs of dead matter can be placed. These letter-boards should have a



Standing galley with racks.

raised rim at the extreme end to protect the matter from being jostled off when the board is suddenly pulled out. In the small job-office a part of the standing galley is often fitted up with separating partitions for short leads and brass rules.

COMPOSITORS' TOOLS

The composing-stick is a small open tray of iron with raised ledges on two sides, and an adjustable knee-piece within that slides to and fro and can be adapted to the width of any measure.¹ It is made in many styles, differing chiefly in the mechanism

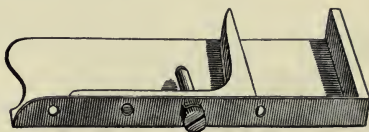

Composing-stick, common form.

by which the adjustable knee is made fast. The common form has a screw-bolt that passes through the back ledge and an opening in the movable knee. The Grover stick, which tightens the knee with its spring clamp and lever, is preferred by many job-

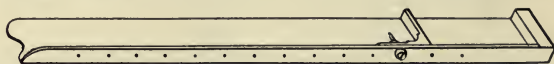

Wooden job-stick.

compositors, for it enables them quickly to readjust the stick to any width of measure.

The form of stick preferred in many newspaper

¹ The sticks of the early printers were rude channels of wood, made to hold but two or three lines. The name has survived, although the material has been changed. Sticks of wood of large size are now made only for the large type of posting-bills.

houses has the knee firmly fastened to the bottom plate, so that the measure can never be unsettled.

Another form of stick has two adjustable knees, one lapping over the other, and so arranged that the matter of two measures can be set in the same stick—one for text and one for side-notes.¹

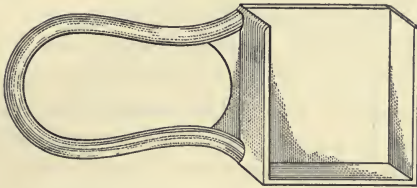

Newspaper stick of unalterable measure.

The stick needs care. If dropped upon the floor, or allowed to rust, or if the knee is strained by over-tight spacing, it is liable to give bad justification.

The bodkin is a straight awl, firmly fixed in a handle, which



Bodkin.

is used for withdrawing a faulty type from the form. Bodkins are also made hooked or bent at the point. The spring bodkin, that shuts up between tweezers, is a more useful tool.

¹French composing-sticks are shallow, holding about five lines of pica. American and British sticks hold ten or twelve lines of pica. It is claimed that the

shallow stick does not fatigue the compositor by its weight, and enables the left hand to follow the right in every movement of picking up type.

The tweezers, that enable a compositor to pick up and arrange types in the narrow columns of a table,

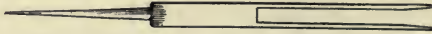

Tweezers.

is a serviceable tool for withdrawing type from a galley or an unlocked form on the stone.

The composing-rule is a movable strip of smooth metal, type-high, of the length of the measure required, against which the compositor places the types that he puts in the stick. The smooth metal allows an easy movement and adjustment of the



Composing-rule.

type when it is caught by the thumb. The rule is also used for emptying the contents of the stick on the galley, as a support for type in the

act of distribution, and for dividing and moving matter in the process of making up. The composing-rules of job- and book-printers, who have to set type to many measures, are usually of brass; those of news-compositors are oftener of steel.

BRASS RULES

Brass rules, cut from hard-rolled sheet-brass and planed to the standard height of type, are usually furnished to the printer in strips two feet long.

They are rolled to conform to the bodies of the point system, and can be had of all thicknesses from 1 to 12 points. Different kinds of face are made, but each one is designated by the arbitrary number of the typefounder. Printers designate them not so often by number as by the names of single, parallel, double, triple, dotted, hyphened, waved, spurred, and fancy.

The faces most used in book-work are commonly known as single, parallel, double, and dotted. The waved, triple, and ornamental rules are never used in plain composition.

These faces are enough for all ordinary book-work. The hair-line and the flat-faced should be in abundant supply, for they will be most needed, but the waved and dotted rules may be of occasional service. When a rule border is planned to consist

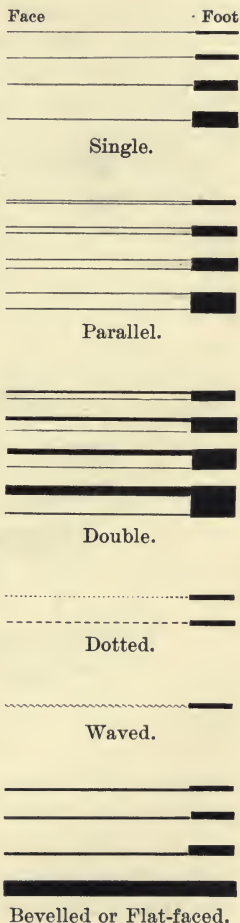

48 *Machines for cutting and mitring*

of two parallel lines, it is better to have these lines cut upon one thick body, for the value of the time given to the mitring and proper joining of rules on two thin bodies is usually greater than the price of the thick rule.

Brass rules, neatly cut to graduated lengths and arranged in convenient cases, are furnished by all type-founders under the name of labor-saving rule, but some printers find it expedient to buy rule in strips and cut it, as occasion requires, to suitable

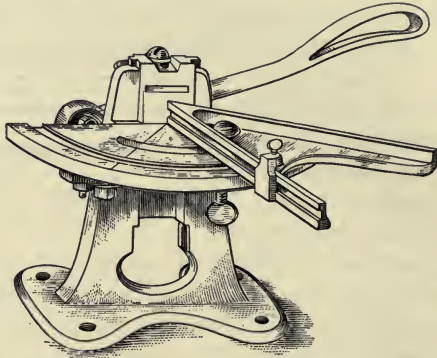

Mitring-machine.

lengths. The tinman's shears and file, or the saw and mitre-box, which were once the only tools in use, are now supplanted by machines that cut the rule without bending, and plane the cut edges with smoothness and accuracy. There are also machines

provided with fine saws for cutting thicker bodies, and with mitring adjustments for any angle.

Rules of prescribed length should first be cut by the gauge a trifle longer than seems needed, and afterward trimmed down by the side-plane of the ordinary machine. Mitred rules should be tested in a true and square stick before they are used, for it sometimes happens that a set of rules may be cut of true length as to face, but over-long as to foot. A slight deviation will prevent a true joint. Side-planing must always be done quickly and with force. If done feebly and timidly upon a weak machine, the rule may spring or the plane may jump and produce an uneven cut. The face of the rule should be first met by the plane; if the foot first meets the plane, a rough edge may be left on the face. Most mitring-machines have dials accurately marked for different angles. In cutting a set of mitred rules for a border, the gauge must be set alternately at equal distances from the right-angled line on the dial. The machine is to be preferred that firmly holds the rule, so that it will not spring.

A miscellaneous stock of brass rules is difficult to keep in order. The labor-saving rules furnished by the type-founder are usually cut to ens of pica for all the smaller lengths; but any house may need rules of intermediate size, and the irregular lengths should be kept apart in a separate case.

Labor-saving rule cases are made to many plans. A diagram that follows shows a rule case made to

hold graduated lengths from one to fifty ems of nonpareil. Some of the small pieces in the small boxes are mitred for right and left joints, so that

Row	1	2	3	4	5	6	7	8	9	10	11	12	13	14	15	16	17	18	19	20	21	22	23	24	25	26	27	28	29	30	31	32	33	34	35	36	37	38	39	40	41	42	43	44	45	46	47	48	49	50					
1	1 1/2																																																						
2	2 1/2																																																						
3	3 1/2																																																						
4	4 1/2																																																						
5	5 1/2																																																						
6	6 1/2																																																						
7	7 1/2																																																						
8	8 1/2																																																						
9	9 1/2																																																						

The ordinary rule case.

they can be attached to large pieces in the larger boxes to form any length that may be desired. With these graduated pieces the rule border can be quickly formed without the delay of mitring.

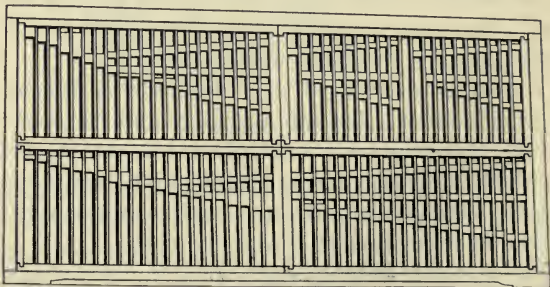

A rule case in four sections.

The rules in the following case are arranged in progressive order, so that any size can be found readily. The strips that divide the compartments are sunk in some places to allow the rule to be seized by the fingers, and raised in others to prevent its bruising from another overlying case. As

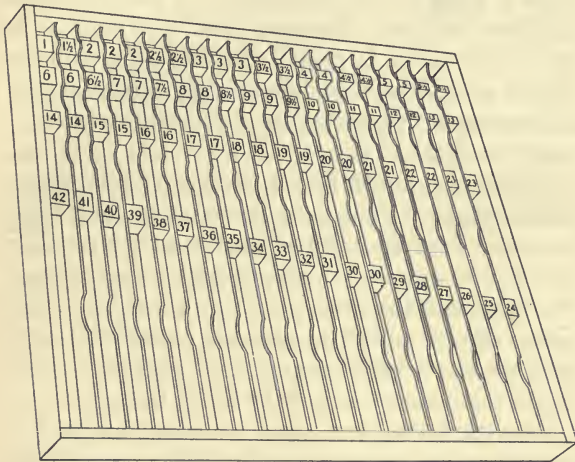

Improved case for brass rule.

brass rules of plain faces are needed now more than flowers or borders of type-metal, they should be kept in ample assortment and in liberal supply. It is also better that each thickness and face of rule should be kept apart in separate cases. Faces that are easily distinguished may be kept together, but single and parallel rule should never be mixed.

That rule case should be preferred in which cut rules can be laid vertically, so that all rules rest on the same base. When rules are so laid, the little differences of length can be readily noted.

It is bad practice to expose rules upon a stand, where they may be bruised by overlying galleys. Brass is harder than type-metal, but the edges and hair-lines are easily damaged, and this damage is always noticeable in print. The counters or channels of parallel and double rule are usually cut at a sharp angle that makes the lighter line weak and easily bruised.

To insure uniform height and true joints, all additions made to stock rules should be bought from the same foundry. Rules from another foundry may not be cut to the same height or set of face. The faces selected should be few in number. The bodies of 1, 2, 4, and 6 points are enough for ordinary work. A large supply of a few faces is more useful than a small supply of many faces.

As with leads, rules must be selected with system, to prevent confusion and needless expenditure. Rules often have to be pieced, joined, or mitred, and it is important that the new pieces should be of the same face and body. When purchases of many faces of rule are made without system from different makers, the rules so bought may differ in height and face, and be combined with difficulty.

For ordinary letterpress work the 2-point rule of hair-line face will be found of most usefulness for

separate columns in tables. The rule borders for these tables should be about 4 or 6 points thick, with their thick lines flush to one side, in this way :



The thick line flush at one side permits neat joints at the corners of a border without mitring, and also allows an exact connection with the cross-rules of tables. For the rules that divide the columns of a page, or that follow a running title, or that precede foot-notes, the thicker body of 6-point with blunt bevel should be preferred.

Flat-faced rules, much used for table-work, should be flush with the body on each side, but for special conditions they may be made with a bevel on one side only.

For electrotype work the thin bodies of hair-line brass rule are objectionable in all places where they are not protected by near-by lines of type. Their sharp-sloped shoulders make a narrow impress in the moulding wax, which impress is often bent or thickened when the moulding plate is lifted from the form of type. The impress may be too narrow to get its needed share of blacklead, or even of soldering tin. It often happens that the backing metal of an electrotype plate does not entirely fill

the impress of a moulded rule. It follows that the rule in this unprotected spot bends or gives way under the pressure of the printing-press, making a crooked or thickened line. This fault is common. It is rare to see in a book printed from electrotype plates all its hair-line rule borders of uniform appearance, or exposed cross-rules that are of uniform straightness and thickness. This fault, too often laid to the pressman, is really caused by the thinness and sharpness of the brass rules. Brass rules with hair-line, intended for electrotype work, should have blunt angles and high shoulders.

Labor-saving rule, accurately cut to graduated lengths, is of advantage in the composition of ordinary work that has to be done in haste, but it should be generously provided and carefully handled. Under the kindest usage the corners will soon round or wear down, making a white line or a blemish where it should show a perfect joint. For very exact work it is safer to use rules of one piece only.

Borders of hair-line rule on 2-point body for inclosing large pages of type should be avoided, for they make needless delay and trouble in composition and presswork. Around small pages in small forms it is possible to print thin rules fairly; on large pages and in large forms they are always unsatisfactory. For a border line the face of 1-point thickness is to be preferred to the hair-line rule.

The border on each side of a page should always be single and perfect pieces of a thick body. When

the rule is thin, it is rarely mitred for a border with accuracy. Even if accurately mitred, the corners may not join. A slight crook in the chase-bars, or slight unevenness in justification or locking up, will prevent the joint. This difficulty is so common that few publishers order pages electrotyped with the rule borders on the plates. They prefer to attach the rules to the patent blocks, on which the rules cannot be disconnected by any ordinary accident.

DASHES AND BRACES

Brass dashes are made to a variety of faces, but the ones in most request are the single, parallel, and double. The ornamental faces, formerly known as French dashes, are now not allowed in book-work.

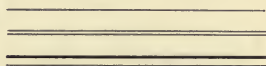

Brass braces are made and sold in sets, usually on 8-point body, varying in length from four to twenty ems, but they are seldom used in book-work. A lighter face, as used in algebra, is now preferred.



Metal rules, made from solid type-metal and cast in moulds to the height of type, are rarely used, for the metal

is unavoidably soft and may be porous, and the rule made therefrom must be weak and liable to injury.

Space-rules are short pieces of metal rule of hair-line face, on 2-point body, cast to even ems and — ens of the regular bodies, but chiefly to — bodies of 6- 8- 10- 12- and 18-point. They — are made for narrow columns in which — short cross-rules are needed. Sometimes — they are used, but unwisely, in place of — vertical brass rules. Space-rules cast to — the length of even ems of the irregular Space- rules. bodies of 7- 9- 11- and 14-point are made to order only. Two or more bodies of the same face in the same house should have a distinct nick on each body and be kept apart in separate cases.

LEADS

Leads are thin blanks of soft type-metal cast or rolled of many widths from 1-point to 6-point thick, in strips eighteen inches long. They are used to widen lines of type, to extend composed matter, and to make print more readable. They are made high and low : the high leads that come up to the shoulder of type are used only for electrotype or stereotype composition ; the low leads, as high as low spaces, are used for letterpress work. The thinner leads, necessarily of high price, are rarely needed. Leads of 2-point thickness are most used, but leads of 3- and 4-point are common. Intermediate sizes should be avoided, for they are not readily identified by the ordinary compositor. If mixed with

approximate sizes, they are not easily separated and may make great trouble.¹

For ordinary book-work the bodies of 1- 2- 3- and 4-point will be found ample. The 1-point lead, rarely used for a text, is always of service in justifying proximate bodies. Leads of different thicknesses can be doubled to make blanks of any other

Thickness of a three-to-pica lead.

Thickness of a four-to-pica lead.

Thickness of a six-to-pica lead.

Thickness of an eight-to-pica lead.

Thickness of a ten-to-pica lead.

Thickness of a twelve-to-pica lead.

width. One thousand pounds of leads so selected will be of more general service than two thousand pounds not selected with system.²

In planning a composing-room, a proper system should be devised for keeping leads in good order. For the smaller measures leads have to be provided in lengths graduated by quarter-picas, for middle

¹ Leads of irregular thickness, as of five- seven- and nine-to-pica, should have special nicks cut on their edges with a saw, so that they can be identified at a glance. When the work containing these irregular leads has been finished, the leads should be papered up and put away.

Under no circumstances should they be made a part of the common stock.

² Very thick leads, commonly called slugs, on 6- 8- 10- and 12-point bodies, are useful as white lines and foot-lines in making up. They are readily made on the linotype machine.

measures by half-picas, for broad measures by full picas. In large printing-houses the lengths most needed are furnished in weights of thousands of pounds. To keep a large supply of leads on standing galleys is wasteful of useful room; to put them pell-mell in boxes or bins invites damage and disorder. A common form is a stout upright closet, divided in pigeonholes for many sizes, appropriately marked with the length of each lead.

Another method is to provide a series of boxes on the top of a low table or cabinet case. Small

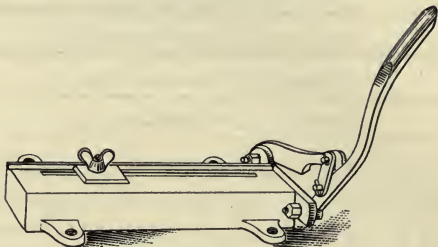

Lead-cutter.

collections of leads may be put in partitions upon a standing galley, making each partition exactly the width of the lead for which it is adapted. They can be kept there in good order with little trouble. Separate galleys or racks should be used for different thicknesses of leads. A very large quantity of any measure in frequent use may be piled neatly in a type-box or bin, but it is impracticable so to treat all the leads for the numerous measures of a large

printing-house. They should be exposed together and made accessible.

Lead-cutters are made of many patterns: some are for cutting leads only, others for cutting leads and brass rules. Cutters with knives that meet at a wide angle bend the lead or rule. The best lead-cutters have an upper knife that descends at a slight inclination, cutting like a chisel. A lead-cutter in-

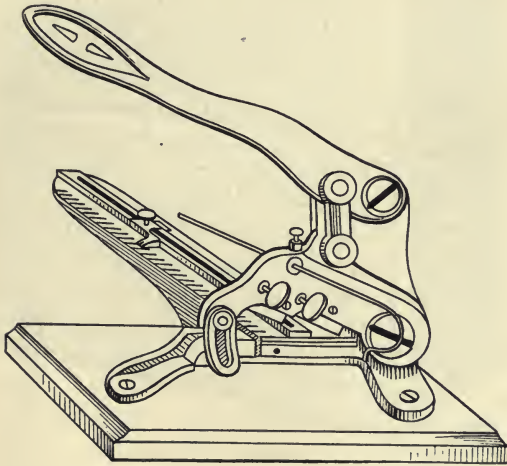

Rule- and lead-cutter.

tended to cut brass rule of even moderate thickness should have a compound lever as well as a strong knife. Slugs and rules of 6-point and larger bodies are more neatly cut with a circular saw.

As leads have to be provided for all measures, of many thicknesses, and of stereotype and letter-press height, they should be ordered with system, to prevent needless and wasteful expenditure.

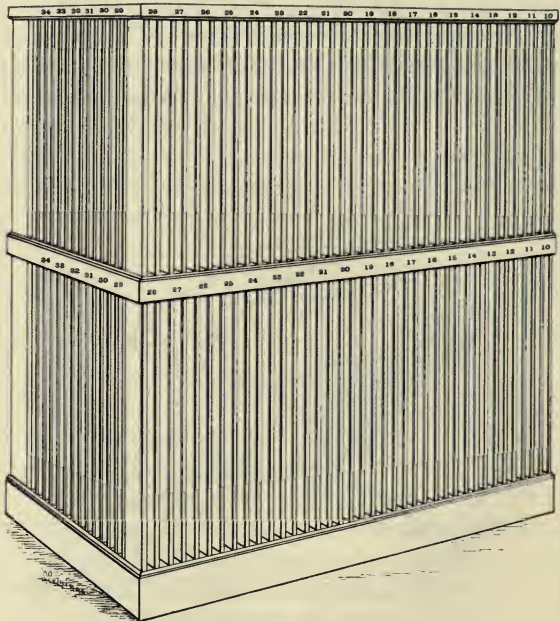

A new form of lead-rack.

The weight of leads in all the widths required for a book-house working in many measures should be at least one half the weight of the text type. In some houses the leads weigh more than the type.

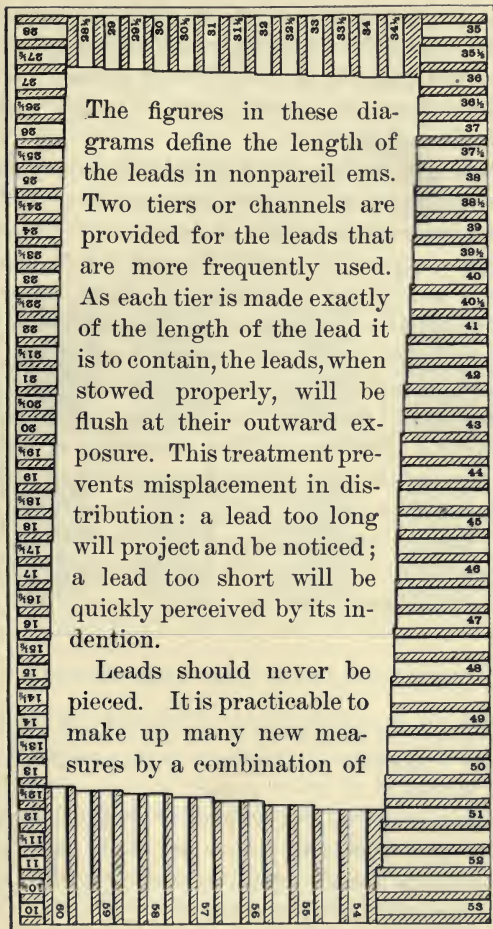

The figures in these diagrams define the length of the leads in nonpareil ems. Two tiers or channels are provided for the leads that are more frequently used. As each tier is made exactly of the length of the lead it is to contain, the leads, when stowed properly, will be flush at their outward exposure. This treatment prevents misplacement in distribution: a lead too long will project and be noticed; a lead too short will be quickly perceived by its indentation.

Leads should never be pieced. It is practicable to make up many new measures by a combination of

Cross-section of the lead-rack shown on previous page.

two or more leads, but the work so done is usually imperfect, and the value of the time lost in piecing is more than that of the new leads. For all broad measures it is better to have leads of proper width in one piece of metal.

Full-length leads can be doubled with safety, but treble-leading is never to be recommended, for it makes composition spongy, and tends to the hanging or bowing of the ends of lines on a wide page.

When new leads are bought to be added to a previous supply of old leads, the new leads should be used together on separate pages or columns. If the new are mixed with the old, there will be irregularities in the make-up and register. Old leads are always a trifle thicker from accretions of dust.

To prevent the sponginess of treble-leading, two-to-pica leads, or nonpareil slugs as they are oftener called, may be used. Slugs of still thicker bodies are also useful for foot-lines and for the division-line of double-columned octavos.

FURNITURE OF WOOD AND METAL

Furniture is the name given to all the low pieces of wood or type-metal that have to be used for the larger blanks in or about a page of type or within the chase prepared for a form of type. Cherry wood is most common; pine is used only for posters and coarse work. Metal is preferred for open pages and work of exact register.

Wood furniture is usually furnished in lengths of three feet, and of many widths from two to twelve picas. For all work printed from type, furniture is made to the height of the low quadrat, or about five eighths of an inch. Electrotypers prefer the height of seven eighths inch.

Reglet is the name given to thin wood furniture less than two picas wide. The widths of pica, non-

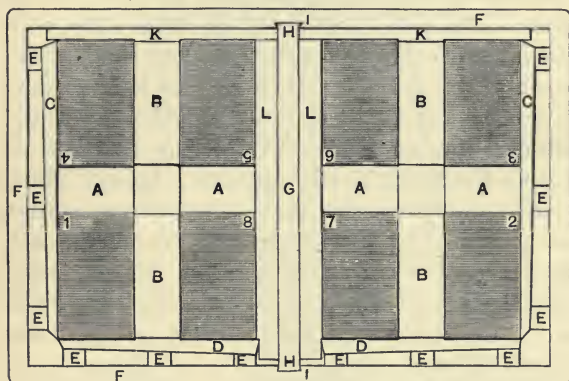

* A form of type in chase, fitted with furniture.

- A, head-bolts; B, gutters; C, side-sticks; D, foot-sticks;
- E, quoins; F, chase; G, short cross-bar; H, dovetails;
- I, slots for cross-bar; K and L, chase furniture.

pareil, and great primer are in greatest request, but other sizes can be had of the thickness of any body.

Side-sticks, or bevelled furniture, are the inclined planes that secure forms of type after they have

been tightened by quoins. For large and heavy forms of type, iron side-sticks are preferred. The pieces between pages 1-8, 2-7, 3-6, 4-5, are often called gutters;¹ those between 1-4, 2-3, 6-7, 5-8, are the head-bolts; the inclined planes at the foot and sides of pages are the bevels or foot- and side-sticks; the blunt wedges between the chase and the bevels are the quoins.

Furniture is more difficult than leads to keep in order. The usual practice of the small office is to buy furniture in yard lengths; to allow compositors to cut it up without system as new lengths may be needed, and finally to throw it, when out of use, pell-mell into an open drawer. This disregard of system wastes time and material. Larger offices usually provide a series of deep pigeonholes against a dead wall, with a separate compartment for each regular length of furniture or reglet. For irregular lengths special compartments are seldom provided, and these odd lengths are too often put in wrong places and make confusion.

The storage of furniture flatwise in pigeonholes or in exposed pockets of uniform depth invites disorder. Each pocket should be exactly the depth of the furniture made for it, so that each piece will reach the end of the pocket and yet be flush with the face. When the pockets are of uniform depth

¹ Gutters are so called because they have a rounded channel planed in the middle of the wood, to prevent it from receiving ink from the inking roller that passes over the form. In a few houses the thin strips near cross-bars are called gutters.

the shorter pieces cannot be seen and the longer pieces are annoying projections. The open pocket has another disadvantage in making no separation

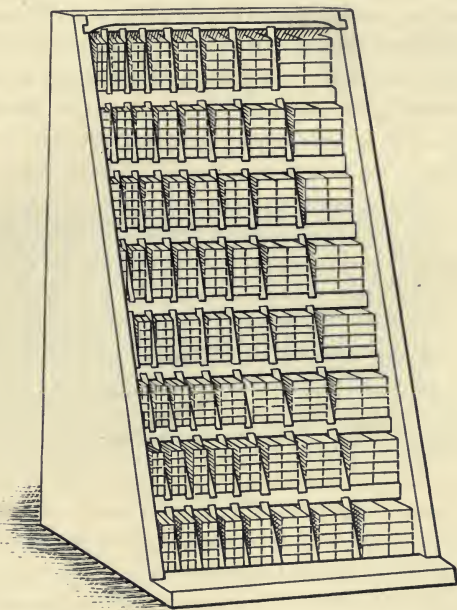

Furniture-rack.

for furniture and reglets of different widths : to get several pieces of one width the compositor has to assort the contents of the pocket. Long pieces of reglet should not be mixed with long furniture.

The surface area of the blank space that is often required inside the chase is usually as much as and sometimes more than that required for type. For this reason there should be provided at least as much surface area of furniture as of type. It is equally important that the furniture should be of graduated sizes, in proper places, and readily accessible. A compositor should be able to select from office stock any length or any width of regular furniture as easily as he selects a needed size or sort of type. It is as bad practice to require him to cut furniture for ordinary needs as to have him cut leads.

For the more orderly stowage of graduated wood furniture, the furniture-rack shown in the illustration on previous page is provided by printers' supply houses. It is made to hold five hundred pieces of furniture. There are eight pieces of each length of the widths two, three, four, five, six, eight, and ten picas. There are eight lengths between twelve and sixty picas, which are graduated six picas apart. Another style of rack is made to hold lengths from sixty to one hundred and twenty picas. It is an improvement on the disorderly furniture-drawer, yet it is imperfect, for every printing-house needs furniture of lengths but one pica apart. Even if the intermediate pieces are not supplied at once, a place should be provided for the new sizes.

A labor-saving reglet-case is also kept on sale, which holds from eighteen hundred to twenty-four hundred pieces of pica and nonpareil. It contains

nine distinct sizes, graduated six picas apart, from twelve to sixty picas. This is not enough, for there should be forty lengths between these extremes. As the reglet stored does not stand upright, resting upon its cut edge, it is liable to disorder.

The furniture-cabinet shown on page 69 contains enough of sizes for all the usual requirements of a book-house. It is intended to be put under an

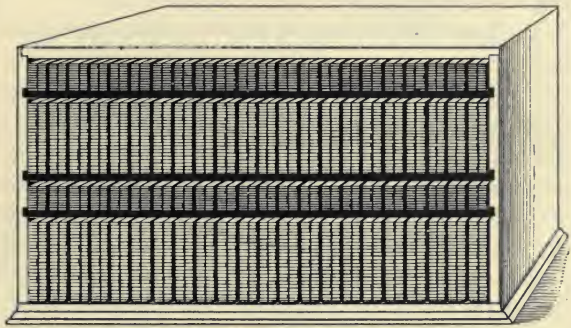

Reglet-rack.

imposing-stone of the dimensions 33×86 inches. As making up in a book-house is rarely done on the stone, the pulling out of a box does not hinder or annoy the imposer of a form any more than the pulling out of a chase from the chase-rack, which is usually kept in the same place.¹

¹ When a dead-wall space is more available, the cabinet can be divided in two long sections, to be placed against this dead wall, but it should be where its contents can be easily examined. Furniture needs a fair light as much as type or leads.

It contains twenty-eight drawers—twelve on one side (not shown in the illustration) and sixteen on the other. These drawers are of unequal height, to suit the different lengths. Each piece of furniture or reglet rests on its cut edge or narrow end. If too long a piece is put in, the drawer cannot be closed; if too short a piece is put in, its shortness is at once detected. The vertical rest of each piece is a safeguard against the mixing of lengths.

Each drawer is divided into two compartments that hold proximate sizes like twelve and thirteen ems pica, so that the compositor can readily select either. Each compartment contains six longitudinal partitions for the six different widths of nonpareil, pica, two-line, four-line, six-line, and ten-line. To pull out or shove in the drawer does not throw the standing pieces in confusion, even when each partition may be but half full, for if they are jostled to fall, they must fall sidewise. Each piece is neatly planed and squared, and has its length in picas stamped by a punch in figures on its end.

These drawers contain fifty-six lengths, beginning with twelve picas and advancing by one pica to sixty picas. Beyond that the progression is by one and a half picas, or great primer—a graduation that is close enough for all ordinary work. For lengths beyond seventy and a half picas, that are rarely required in book-work, two or more pieces can be combined. As each piece is properly numbered, the compositor who may pick it up when out

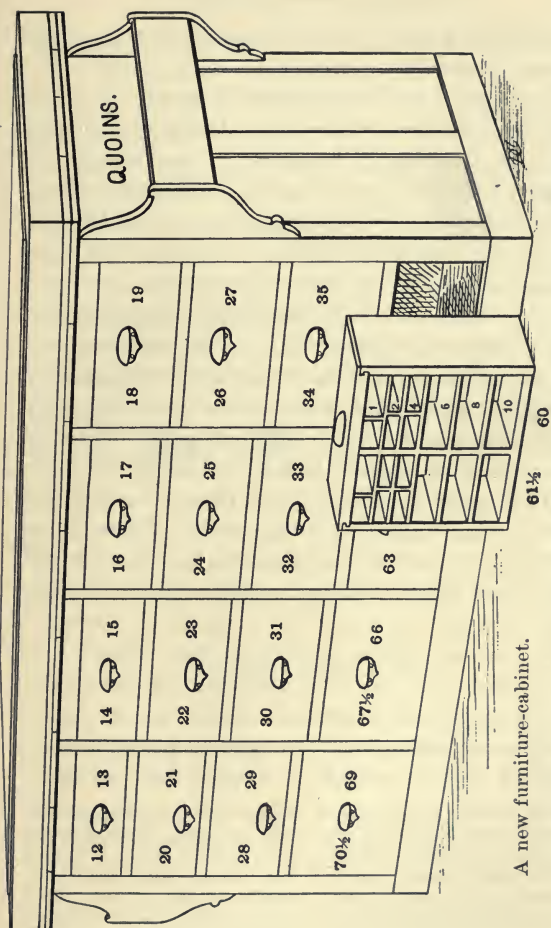

A new furniture-cabinet.

The other side of this cabinet has drawers for these lengths in pica ems :

- 36, 37, 38, 39, 40, 41, 42, 43, 44, 45, 46, 47, 48, 49, 50, 51, 52, 53, 54, 55, 56, 57, 58, 59.

Reglets of varying sizes are put in the boxes not numbered.

of its place knows at once in what drawer of the cabinet it should be placed.¹

For posters and large job-work another form of furniture-rack must be devised. Drawers that hold many pieces of long furniture are too weighty to be moved in and out with ease. The open pigeonholes with pockets of unequal depth (after the system of the lead-rack as shown on page 60) will be found convenient, but these pigeonholes should be properly subdivided with partitions for the separation of different widths. To be of general and lasting service these pigeonholes should be constructed on a generous plan, to make special place for every length that may be needed, in graduated lengths at most two picas apart. It may not be expedient to get all sizes at once, but places should be reserved for new sizes when they are bought. Where space is crowded it may be judicious to keep long furniture under different stones or cases; but it is better practice, when the space can be given, to construct against a dead wall a large rack with a pigeonhole for every size in use, with provision for intermediate sizes to be afterward furnished.

Wood furniture is cheap, light, and can be easily handled, but it is liable to shrink, fray, or warp.

¹ The cost of a fully equipped cabinet of this pattern is not small, but it is much less than the sum usually paid every year for wasted time, wasted material, and unavoidable confusion. A cabinet of this form, with fair care, will be serviceable for more than a lifetime. It will not only prevent waste of labor, but will help the compositor to produce quicker as well as neater work. Neglect to provide cut furniture is not wise economy.

For exact work, metal furniture is always preferred. The illustration annexed represents a sectional view of an old form of metal furniture, which is made in lengths of twelve inches, of seven widths from two- to ten-line pica. This form has the merits of strength, stiffness, and accuracy, but it is not adapted for combinations of unlike pieces.

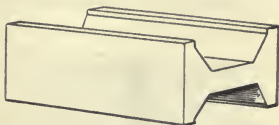

Combination metal furniture is made of many widths from three- to ten-line pica, and from five- to thirty-line pica long.



Its open centres make it light, and its interior bridges insure a reasonable strength. There is

another form, rather stronger and heavier, with hollow or oval centres, without connecting bridges.

FURNITURE-RACKS

Metal furniture that has been roughened by careless handling cannot be combined with precision. Nor can combinations of small pieces be safely used for the head-bolts or gutters of book-forms, for they lack the stiffness that is required to keep types squarely in line. For the head-bolts and gutters of book-forms single pieces are better. The roughening of improved metal furniture is largely

caused by bruising it with the shooting-stick, or by throwing the pieces pell-mell in an open drawer. To keep the edges free from bruising, it should be

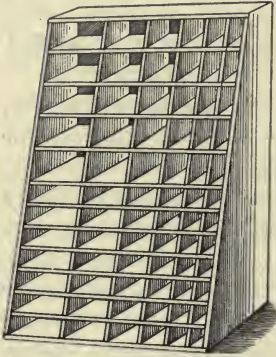

Rack for metal furniture.

handled with as great care as types; it should not be dropped upon the stone; it should be kept in neatly piled columns and in pigeonholes that have a separate compartment for every size.

Large pieces of combination metal furniture are of limited value; the larger they are, the less they can be used. Many printing-houses discard them, and make up blanks from a combination of small pieces that can be used anywhere.

QUOTATIONS

The most serviceable forms of metal furniture for inside composition are quotations cast on the body of three by four picas, but they are sometimes connected in one piece, in lengths of eight, sixteen, and twenty picas. As they combine the good qualities of strength and light weight with adaptability to all pages, they are used in some houses to

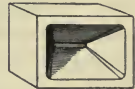

the exclusion of other forms of metal furniture. Justifying spaces of three-line and four-line body should be a part of every supply of quotations. It is not good workmanship to justify them with the quadrats of smaller bodies, for they annoy the electrotyper. Pages to be electrotyped need for all their large blanks a special form of quotation, of higher body, concave on two sides, but solid and

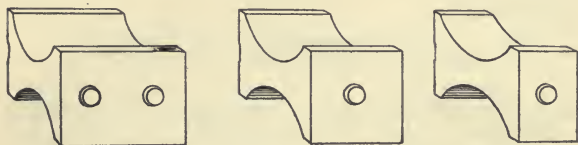

tight at top, with projecting disks or bearers that equalize the pressure of the moulding press and prevent the splurging of the moulding wax.

ELECTROTYPE GUARDS

Pamphlets and books of limited edition continue to be printed direct from type, but all books that are expected to have large sale from two or more editions are invariably printed from electrotype plates. The proper preparation of the pages for the different processes of moulding and finishing in the making of these plates calls for additional guards within the pages, and especially in all chapter heads and tails. The guards provided by type-founders

74 *Quadrats needed in electrotyping*

are quadrats cast with shoulders as high as those of the types of the text. On the top of these quadrats are circular disks full type-high, that serve as aids to even pressure from the moulding press, and prevent the outspreading of the moulding wax.

These quadrats with guards serve another useful purpose by protecting the letters on the plates from bruises while they are in the hands of the finisher

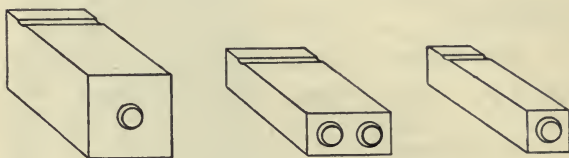

Quadrats preferred for electrotyping.

and prover. Much to the bewilderment of an unpractised proof-reader, these black disks often appear on the author's proof, but they are routed off when all corrections have been made and the plates are pronounced ready for press.





JAMES HARPER

III

COMPOSITION

Time-work and piece-work . . . Customary routine on books
Justification . . . Spacing and leading . . . Distribution
Hand-work and machine-work . . . Proper methods of
hand-work . . . Recent mannerisms

TIME-WORK AND PIECE-WORK



COMPOSITION in every book-house is done by two sets of workmen that are respectively called time-hands and piece-hands. It is oftenest a matter of contract. The publisher requires an employing printer to furnish perfected composition at a fixed price per page or per thousand ems. In turn the master printer agrees with his piece-compositors to have them do the type-setting part of plain composition at a fixed price per thousand ems. The price given

to the compositors includes the distribution of type and the correction of the compositor's faulty work as it may be marked by the office proof-reader, but it does not include other service that is needed to perfect the contract with the publisher. Making up and stone-work, proof-reading and superintendence, all of equal importance, are not paid for by the piece, for the work done in each one of these departments is of too irregular a nature and is too unequal in its requirements of time and dexterity to be adjusted by fixed prices. They must be done by day's work, or "on time," as printers phrase this method. The cost of this supplementary work is variable, seldom less and often more than one half of the cost of the type-setting that has been done by piece-hands. Although the composition of books is usually rated as piece-work, it should be understood that about one half of it in value is time-work of uncertain cost.¹

CUSTOMARY ROUTINE ON BOOKS

When an agreement has been concluded with the author about the style of an intended book, the copy should be examined by an expert, who will take note of the possible need of additional sorts

¹ Spelling, abbreviation, punctuation, and other matters that belong to the literary side of type-setting have been noticed in the treatise on *Correct Com-*

position. In this and following chapters. remarks and suggestions have to be confined to the purely mechanical side of book composition.

that may be required in excess. These sorts may be accents, signs, small capitals, italic, figures, or new characters, but they should be procured and put in case before the copy is given to the compositor.¹ To begin composition without the needed materials, and to "turn for sorts," is always wasteful of time and productive of error. Obeying general directions, the expert may specify the types for chapter headings, subheadings, tables, extracts, and notes, and must try to give proper directions for uniformity in the use of capitals, italic, quotation-marks, etc. Here his duty ends. He must not edit.

Copy is invariably given out to piece-compositors in portions known as "takes," which will vary in quantity from ten to one hundred lines or more. Short takes are given when work is in haste, and the compositors are required to empty composed matter on a galley in a prescribed order. By this method the galley is quickly filled, and may be as quickly read and corrected. Long takes are given when work is not in haste and when the compositors are of nearly equal ability.

The compositor should give close attention to spoken and written instructions before he begins to set type. If they are insufficient, he should ask all the necessary questions. In no case should he begin composition until he knows what he must do with every uncertain feature of his copy.

¹ It is not wise to order sorts in small quantities by a guess as to their weight. Specify the number wanted of each character.

Print is always more readable when each change in its description or its argument is presented in a fresh paragraph. Dialogue matter should have a new paragraph for the words of every speaker, but the paragraphing should have been settled by the author in the copy. If the compositor thinks that the matter is too solid, he may show it to the foreman and ask him or whoever is in authority to decide the doubt, but the making of a new paragraph is not in his province.

Three methods of performing routine work on book composition have been practised. An old method required the compositor who held the first long take to make up in pages the matter he had composed and to pass his incomplete page with its copy to the holder of the second long take, who pursued the same routine with the holder of the third take. In like manner, make-up was passed from hand to hand until pages enough had been made up to fill the form. Every compositor laid his made-up page upon the stone, and was held responsible for the correctness of his making up and for its proper placing. The fitting up of the chase with furniture, the adjustment of margins, and the locking up and proving of the form were done in turn by each compositor. This method equitably divided irksome duties among all the compositors, but it had to be abandoned when an expert workman mated with too many in experts had to do more than his fair share of the work.

Another method was that of companionship. By this method the compositors on the book elected their own maker-up, who was thereby made an assistant to the general foreman. He received the copy entire and gave it out in takes to each compositor. When there were many compositors, he attended chiefly to make-up and stone-work; when there were few, he did composition when not otherwise employed. He ascertained the daily special needs of counting-room, press-room, and reading-room, and arranged his work so that time would not be needlessly lost in any department. He had the right to order any compositor to do corrections or other work of like nature at his pleasure. By English usage, he could fine a compositor for bad work or for shirking duty. He kept a schedule in which he recorded the lines set or the work done each day by each workman. The value of the head- and foot-lines and blank lines he had composed was separately computed, and the pay therefor was divided among the compositors in proportion to the number of lines each compositor had set. The maker-up received, as had been agreed on, a fixed price per page or per thousand ems, or the same amount as the compositor who had realized the largest bill. The intent of the companionship was to quicken performance, to make men help one another, to prevent the shirking of duty, the hoarding of sorts, and the taking of unfair advantages of any kind.

This method of working in companionship is no longer practised in the United States. There are few competent men who will make up for a companionship, for the pay conceded is usually insufficient. There is a general undervaluation of this labor, not only by compositors, but by publishers, and even by some master printers.

Make-up and stone-work are now performed in all American book-houses by men appointed by the foreman. Their service is paid for "on time," for make-up by the piece, which may seem the cheaper and quicker method, is too often done wastefully, apart from its imposing needless labor upon other time-hands. It is seldom well done in all details unless the time and methods of the maker-up are entirely under the control of the foreman.

Compositors deliver their copy and the matter as it is set to the maker-up, who has their galleys proved, and then passes the copy and proof to the proof-reader. Illustrations furnished with copy that cannot be proved on the galley¹ are put by him in the proper place as attachments to the proof, and subsequently measured and allowed for at the

¹ In some book-houses proofs are not taken upon the galley. Matter is made up in pages as fast as it is set, and the pages are proved in strings on a press or with proof-planer on stone. This method saves the employer the cost and care of many galleys, but it does not quicken or improve composition, for the

correction of outs or doublets will compel the overrunning of many pages. When many proofs are required by the author, and paragraphs are cancelled or added, all the pages of a chapter will have to be untied and retied, with more delay and increasing liability to new errors in every alteration.

same rate as composed type ; but all the other fat matter that has been composed and arranged by the maker-up, as full-page cuts, head- and foot-lines, chapter heads and tails, is not reckoned for the benefit of the piece-compositor. The illustrations, often delayed for many days, are seldom furnished until type is ready for make-up.

Electrotyping has materially changed the old routine and has put extra labor on the stoneman. Instead of imposing sixteen pages of octavo in one chase, the stoneman now has to put one large or four small pages in the chase, and to give more attention to many small chases than he formerly gave to one chase. When great nicety of moulding is desired, one page only is put in a chase, and additional bearers have to be added in every exposed blank. The time now allowed for the proper preparation of the pages is much greater than that heretofore given to the ordinary letterpress form.

The maker-up rearranges the copy in order, and compares it with the composed type on galley to make sure that there have been no omissions or transpositions. A proof of the galley is then taken, usually on a proof-press of the form shown in the illustration on the next page.

Proof-paper should be thin, sized, smooth, and but lightly dampened. Ink should be stiff and repeatedly rolled on the ink-table, so that it can be thinly and evenly distributed upon the type, which should be rolled slowly and carefully to produce

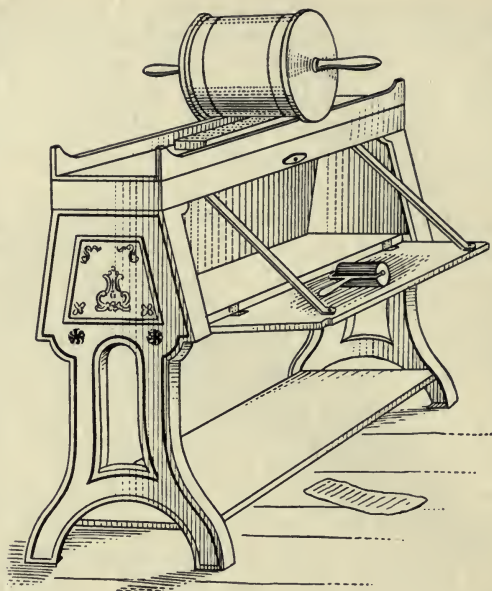

This is the press most used for proving galleys, but it will seriously damage type if the galley has been underlaid with cardboard, or if the cylinder has been covered with an extra wrap of paper or too thick a blanket. These rude methods are often practised when the proof-paper is unsuitably dry or harsh and does not give a readable proof with moderate pressure. If the galley is kinked, or uneven at the bottom, or if the type has

not been truly planed down, this iron cylinder will do more harm to the type than is afterward done by the printing-machine.

Another form of proof-press has its proof-paper in an endless roll, and an automatic inking-roller that precedes the movement of the cylinder. These devices materially lessen the work of taking proofs. In newspaper houses, that prove many galleys together, a new form of proof-press is worked by steam-power.

a readable proof. An overinked proof prevents the reader from detecting imperfect letters.

When the reader has marked all the errors noted in the proof, has put down his queries, and has checked in proper places the names of the compositors, the proof is returned to the compositors for correction. Unless otherwise directed, correction takes precedence over all other work. Each compositor corrects the errors of his own composition, and passes the galley to the compositor next in order until correction is complete. A proof for revise is then taken, and the reviser compares this revise with the first proof. If any error marked has been neglected or wrongly corrected, this error is again marked on the revise, and is returned to the neglectful compositor, who is required to correct it properly and to furnish a clean proof. The galley so corrected is returned by the compositor with the corrected proof to the maker-up.

When the matter is a strict reprint that will not receive any change in text, the maker-up proceeds to put it in page form, and the pages so made up are then imposed in a chase. If, however, a chase is not to be had, the tied-up pages are laid on the stone, and a pounded proof is taken with the proof-planer from the pages still in the strings. This is not a procedure to be recommended, for proving in strings tends to displace thin letters at the ends of lines and to work types off their feet, but it is often an unavoidable practice. After ink

on the proved type has been imperfectly removed with a brush moistened with benzine,¹ the page is inclosed in a wrapper of stout paper and is put upon a letter-board or bank for future use.

For manuscript copy that may receive changes in the text, another proof should be taken on the galley, and this proof should be sent with the first proof corrected to the proof-reader, who adds his queries, stamps it with the proper date, and forwards it to the author with the copy. The author returns it with his alterations, but he may require another proof containing the correction of these alterations. It is always a great risk to make up before the author has finished corrections, or before the cuts or diagrams are ready. Overrunning of type in made-up pages is slow and expensive.

When the author has nothing more to add, and all the illustrations are in their places, the matter may be made up in pages. At this stage the routine differs. In a few houses the second reading of the printing-house is done by the foundry-reader upon the page proof sent to the author. This can be done with safety when it is surely known that

¹ The cleaning of proved type is usually the duty of the office-boy, who often does this work slightly. His few passes of the brush over the type may clean the face, but they push much undissolved ink over the face on the shoulders and in the counters of the type. In these places the adhering ink receives

daily deposits of fine dust, and dries slowly, until it is so firmly attached to the metal that it has to be removed by steam or boiling lye. It is better to prevent than to cure this fault. A moist sponge, following the application of the brush, if properly used, will sop out the gummy deposit left by benzine and foul ink.

nothing more will be added to the proof by the author. A reading of the page proof by the office reader before it will be seen by the author gives the latter more time to consider queries and to approve or disapprove proposed suggestions. In other houses the final reading or the reading for foundry is given only when the author returns the proof as entirely corrected. This is a better method, but it takes more time and may compel the resubmission to the author of another proof.

All proofs sent to an author should be returned to the printing-house, even those that have been faithfully corrected and revised and are apparently of no future value, for every proof contains some memoranda of the readers on the margins that are needed for the perfection of the work.

Book-work should receive two readings at the expense of the office. The compositor is required to make his work correct to copy and to maintain uniformity in style, according to his instructions. After composition has been made correct to copy and is put into pages in a workmanlike shape, the printing-house has completed the part of its contract that concerns composition. All changes subsequently made by author or publisher, whether in the type or in the arrangement of paragraphs or illustrations, including the time spent in the re-reading by copy of subsequent proofs caused by the overrunning of matter, are rated as author's alterations and are at the publisher's expense.

JUSTIFICATION

A common fault of the novice at composition is that of justifying one line tight and leaving another loose. It is a mistake to assume that a line loosely justified can be made tight in the form by vigorous locking up. It may be made apparently tight by strong locking up from the foot, but when the form is lifted up from the stone a type may drop out unperceived, or it may be drawn out on press by the suction of the rollers. This is a serious fault, for the absence of one character in the print may necessitate the reprinting of the entire sheet at a great loss.¹ In the book-printing house, that compositor who does not justify lines firmly is rated as a careless workman, whatever his age or experience.

A line is not satisfactorily justified if it will not stand in the stick unsupported by the composing-rule. If the leads project beyond the type, or if they are flush with the type, the lines so treated cannot be tightened by side-pressure. They may be feebly held by the pressure of the foot-stick, but there is always a liability that a loosely justified line will work off its feet sidewise or produce an

¹ Exact justification is needed now more than it was in earlier days, when types were printed on hand-presses in small forms. Loose justification was then imperfectly corrected by "scale-boards," or dampened slips of spongy cardboard put between the line end and the side-stick. When presswork is done direct from large forms of type, exact justification is obligatory.

imperfect impression. Over-tight justification is a rare fault, but it is equally mischievous. Uneven justification by two compositors on the same page may prevent the joining of mitred brass rules.

Large type in a narrow measure can be justified moderately tight; small type in a narrow measure must be made full tight. Practice with different bodies of type is needed before the required degree of tightness can be fairly understood.

To justify nicely, the compositor should have at hand enough of thin spaces and hair-spaces, and they should be kept separate in distribution. It is not correct practice to put four-to-em and five-to-em spaces in the same box. Their distant position in the ordinary case is a serious hindrance, for time is needlessly lost in reaching after them. Justification would be improved if cases could be made with boxes for all kinds of spaces clustered under the compositor's hand. The so-called self-spacing types and spaces on point-sets are other aids to justification.

Job-printers have to make use of very thin spaces, cut from ten-to-pica leads or thin brass or cardboard, for the justification of large types. When proper spaces have been selected, a job in a large form can be locked up securely with slight taps of the shooting-stick. Forms that have been neatly justified save great waste of time on the stone; they prevent the wear of type from violent planing down, and aid the pressman in making ready.

SPACING AND LEADING

Uneven spacing between the words of a line is a common fault. In book-work it is required that the space between the words of a line shall seem uniform in width, but to produce this appearance of uniformity spaces of different thickness must be selected for use between types of unlike form. The tall *d* at the end of one word and the tall *h* at the beginning of the next word call for a thicker space than that selected for the meeting of two round types like *O* and *e* in a similar position. The space after a comma or an abbreviating period may be thinner than that used after an unpointed word. These may seem trifling niceties, but their neglect damages the appearance of print.

The space most acceptable between entire words in solid and thin-leaded composition is the three-to-em space, and it should be used on all types with round letters of ordinary height, in which the height of the *m* is about one half that of the body. If the round letters are higher, occupying a much larger part of the body, spacing may be wider; if they are lower, as in the case of a brevier on bourgeois body, spacing may be narrower. Wide-space fat type; thin-space condensed type.

To lessen the unsightliness of too wide spacing between separate words, put a thin space on each side of the hyphen that connects compound words.

When the em dash is used in the middle of a line, put a thin space before and after the dash. This thin space may be omitted when the dash is preceded by a period or comma, which is too often needlessly ordered in this place.

When the words of a line have to be thin-spaced, the em quadrat that divides sentences in that line should be replaced with an en quadrat or a three-to-em space.

The rules that require uniform spacing between words come in conflict with other rules concerning an arbitrary division of words. There are words, like *through* and *George*, that are rated as indivisible. To get in words like these at the end of a line compels thin spacing; to drive them over to the next makes wide spacing. Either alternative is objectionable. To prevent the fault, the paragraph may be overrun, but this expedient is always impracticable in a narrow measure. Even spacing often has to be sacrificed for correct divisions.

In double-columned matter, solid and of narrow measure, thin spacing is preferable. In the broad measure, especially with double-leaded type, wide spacing is better, but the en quadrat should be a fair average for all open composition. Spacing too wide produces "pigeonholes" between words, and they are more unsightly than too thin spacing. Even in leaded work it is better to thin-space the last line of a paragraph than to make a new line that has two or three characters only. Very

thin spacing is permitted in poetry when it prevents the turn-over of a short syllable.

Lines of capital letters should always be leaded and spaced wider than the letters of lower-case. The en quadrat may be used when a few words of capital letters are put in the text, but when a short line of capitals appears in a chapter heading, its words should be separated by two thick spaces. In a short line of an open title-page, set in two-line letters that nearly fill the body, the words may be properly spaced with the em quadrat.

In electrotype composition a projecting *f* at the end or a *j* at the beginning of a line should be followed or preceded with a five-to-em space, to prevent the breaking of its projecting kern.

Narrow measures make even spacing difficult, especially so in the very short lines of text type that are led down by the side of illustrations. The spacing of single letters is a common practice, but it often makes unsightly work. To space words with the em or two-em quadrat is an unpleasant alternative, but over-wide spacing between words is not so disagreeable as spaced lower-case letters. Side and cut-in notes are not improved by spacing single types; when the author cannot change their wording, the types should pass unspaced. •

The rule that prohibits the spacing of lower-case letters should not be applied to capitals, for although irregular in form, they are fairly uniform in width. Thin spaces judiciously placed between

meeting letters, like I and H, that have upright stems, and omitted between letters that have inclined stems or are of irregular form, as in A, Y, and L, make the line more pleasing. In an unspaced line, all meeting types with vertical stems seem huddled, while types of angular form seem awkwardly separated. The fault is easily corrected by thin-spacing the types with upright stems that approach each other too closely. In all book titles and running titles, an irregular spacing of lines of capital letters will conceal the faults of inequality. The author who may be displeased with the general effect of a title-page, and who does not know the cause of his dislike, may have his displeasure removed by the irregular spacing of letters that are too close.

The leading of lines calls for as much care as the spacing of words. Leads or blanks improperly selected will mar the fairness of any composition. Ordinary descriptive matter calls for no caution other than the repetition of the remark that all the leads used on a book should come from one foundry and be exact as to thickness, so that all pages shall be of even length, and each line shall truly register its mated line on the back of the page.

Composition that is broken in its text by lines of poetry, extracts, or tables of figures, or that has many short articles separated by dashes, will require the leads to be differently adjusted at each break. In solid composition a white line or less of

the text is enough to mark the distinction, but when the text is double-leaded and the margins are wide, the blank may be wider. A page intended to be open and readable is seriously disfigured by the pinching of space at every break. Prodigality of blanks in solid composition is equally offensive. The rules laid down for even spacing should apply to leading: for solid work, thin spaces and narrow breaks; for leaded work, wider spacing and blanks.

When the last line of a paragraph before a break consists of one or two words only, leads may not be needed before the break, for the white made by the quadrats that fill this last line may be enough. If leads are added there will be more blank at the top than at the bottom of the break, which is not pleasing, for the blanks above and below should seem alike. When paragraphs are separated by dashes, there should be, as a rule, about one lead less before the dash. The shoulders of the letters in the last line usually make a blank equivalent to the width of one lead. When the same number of leads are put on each side, the dash will seem out of centre, with more space above than below.

Wide blanks should never be made with leads; a column or page so treated is spongy and is liable to bow or hang in locking up. White lines of large quadrats will make the work more solid.

The ordinary paragraph is usually indicated by an em quadrat at the beginning of the first line, but

the first line of a chapter, or any line following a short subheading or a running title, or with a full white line over it, needs no indention—not even when it is without an initial or a two-line letter. The white space above gives enough of relief to arrest attention.

Indentions of two or three ems are occasionally demanded for broad measures and double-ledged matter, but these broad indentions make awkward gaps when the last line of the preceding paragraph ends with a short syllable of three characters only. For remarks on different forms of indention, see the chapter on Indention in *Correct Composition*.

DISTRIBUTION

Distribution, much more difficult to the novice than composition, must be preceded by dampening the types to keep them from falling apart. Not more than three lines should be taken in the hand at the first attempt, but this number can be increased as expertness in handling is acquired. The novice should not undertake distribution until he thoroughly knows the proper box for every character. A printed diagram of the case should be before him as a guide. Accuracy is of importance, for type wrongly distributed is sure to be detected in proof.

Type for distribution should show whiteness of face before it is placed upon the letter-board. If it is foul, grimy, and sticky, the type should be

immersed in a solution of hot or even boiling lye. Another solvent of dirt is live steam on the galley. For slight foulness use benzine, but the after deposit left by benzine and undissolved ink will call for the application of diluted ammonia or potash.

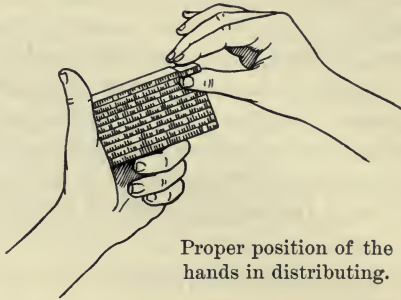

The novice should distribute carefully and make sure that every type is put in the right box. Speed can be acquired by practice only. As every type wrongly placed makes serious delay in its correction, it is of no advantage to hurry distribution. It will take more time to change one wrong type in the proof than it does to set a dozen letters in the stick. If this wrong letter compels a respacing of the line in the stick, the time so spent will be as great as that taken in a setting of twenty letters. When distributable type contains unusual words, the spelling of these words should be understood before their types are parted. It is better to read the line, and to take up the full word when it can

be done. The eye should follow the type in hand until it drops in the right box.

When distribution can be done before meals, the composition of moist type may be avoided. The boxes should not be filled so high that their types can be jostled into near-by boxes. The case should not be shaken to make it hold more letter. The types can be more easily picked up if allowed to remain as they fall from the distributor's hand.

A stick or a short galley should be kept on the ledge of the upper case to receive words of italic or characters that belong to another case, and they should be put in the proper case at once.

In distributing words or lines that are unlike those of the text type, carefully examine the nick as well as the face of the distrusted letter. Do not be deceived by a general appearance of similarity. Do not mix old and worn with new letter, even if nicks and faces are alike. Make sure that the type is returned to the case it came from.

White lines, folio lines, and all matter that may be used again should be put on the standing galley as directed by the foreman.

The correct distribution of Greek, Hebrew, accents, signs, and unusual characters will be greatly aided by printed diagrams of cases, which should be kept exposed for the use of new compositors. Each box of strange types should have a print of its proper character pasted upon its inner side where it can be easily seen.

HAND-WORK AND MACHINE-WORK

Machines for setting type are now common in many printing-houses, but at this date (1903) they have not seriously damaged the business of the expert book-compositor. In a few houses they have deprived men of employment, but in others they have increased the number of compositors by creating work that did not previously exist. Yet their field of service is relatively limited. At this stage of their development, type-setting machines are not serviceable for any body larger than 12- or smaller than 5-point, and are most used for bodies between 5½- and 8-point. They do no more than set type. They cannot read proof, correct, make up, impose, do stone-work, or even set up the more difficult kinds of book composition, which are done now by hand as they have been for more than four hundred years. The need of workmen expert in hand-composition is now as great as ever, and it will be greater in the future. Preliminary practice at case is needed by every operator on machine.

One reason for the continuance of hand-work in type-setting is the capricious tastes of authors and publishers. Every large printing-house has to provide many faces of roman type, yet few of the faces so selected can be adapted with economy to machines. Types that are very large or very small or of any peculiar face must be set by hand. The

composition of books of music or of algebra, or of plain roman type that has to be interspersed with more than one face of display letter, or with complex tables of names or figures, with cut-in notes, or with other odd arrangements, cannot be done economically by an unintelligent mechanism, however skilfully it may be directed. All composition that requires thought, care, and the watchful adaptation of means to ends in every line continues to be done by hand.

PROPER METHODS OF HAND-WORK

Expertness in composition by hand is acquired by preliminary practice at ease—by attention to the trifles that conduce to excellence. Practice should begin with correct methods, and the husbanding of endurance is to be considered first. Type-setting is not hard labor, but it is tiresome, and it will be fatiguing if false positions are taken before the case and needless motions are tolerated. The height of the case, the position of the feet, the distance from the stand, and even the inclination of the stick, affect performance. Some of the positions required, like the twist of the wrist to a boy learning to write, seem irksome in the beginning, but after practice these constrained positions are followed by the least fatigue.

The case should allow a free play and reach of the right arm, but not be placed so low as to cause

bending of the back. Properly adjusted, the case may seem too high, but a high case keeps the body erect, shortens the play of the arms, and prevents the weariness that follows continued stooping.

The feet should be so placed that the body can be kept erect and not be swayed too much from side to side. The work of reaching for a distant type should be done largely with the arms. The crosspiece at the base of the stand should seldom be used to rest a tired foot, for the temporary relief it gives is deceptive. The sitting posture, that may be used with propriety in distribution, is a real hindrance to quick composition.

The stick in the left hand should be so inclined

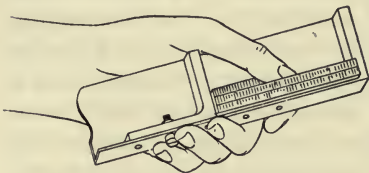

that the type put therein will strike the composing-rule at a correct angle. When not exactly inclined, false and delaying motions will follow. The stick should follow the

hand that picks up the type. It is hard to train both arms to work in concert, but when they do performance is always increased.

The eye should select the type before it is seized by the fingers, and this type should be taken, nick out, on the upper part of the body, so that it will not have to be turned in the fingers.

From a strict reprint copy, the spacing between

words should be copied as each word is set. In manuscript the full sentence should be read and thoroughly understood before the first type is seized. Punctuation cannot be properly done when only half or quarter of the sentence is understood. Neglect to read the complete sentence will compel some waste of time in a more frequent inspection of the copy, and will increase the liability to make outs.

The typographic formulas of the house should be understood before composition. Many printing-houses have a printed code for the proper use of capitals, italic, points, and abbreviations, that requires close reading and memorizing.

When foot-notes appear in the copy, these notes, set in small type from another case, should be put next to the line that shows the mark of reference. The maker-up will arrange them in their places.

Justifying spaces in the last or quadrat line of a paragraph should always be put before the quadrats.

Each type should be dropped in the stick quietly, without the nervous haste that produces false motions. A quick compositor never seems in a hurry; he never allows his animation to reach a fidgetiness that deprives him of the perfect control of his hand. False motions come from excessive eagerness to be fast before the hands have been taught to keep their proper pace. The novice should make haste slowly. He should set type quietly and steadily, refrain from talking, and give entire attention to composition. Nerves must be husbanded as well

as muscles. Any habit that dulls the sensibilities or disturbs tranquillity is always followed by some mental depression and feebleness in performance.

- Quick motions can be acquired by working steadily. To work actively for a few hours and but languidly for the remainder of the day will not produce the desired speed. If a novice finds that he cannot set more than five hundred ems in an hour without undue exertion and a tendency to false motions, he should not attempt more, but he should not allow himself to do less than five hundred. If he works day after day with reasonable earnestness, he will gradually increase performance and will do more work with less effort. The error of many apprentices begins with the unreasonable expectation that they can acquire speed quickly. They try to push execution beyond ability, and in so doing acquire the bad habit of false motions, and become slow compositors for life.

When the compositor can control his time, he should do routine work at set hours, distributing and correcting at the end of the day.

A bright and neat-fitting steel composing-rule, a polished stick, and a clean case free from dust are great aids to composition. Good light is valuable. Light is not always to be controlled, but the rule, stick, and case may be. The workman is known by his tools. A rusted stick or a short or crooked rule will diminish the performance of any workman. Expert compositors own their own sticks and rules,

and will use no other. They get used to their size, weight, and feeling, and say that they can do more work with them than with other sticks and rules apparently as good.

To seize a type readily, that type should be allowed to rest exactly where it falls in the box during the process of distribution. The case should not be shaken up, nor should the little mounds formed by distribution be smoothed down. When types are shaken up or flattened down in parallel rows, it is difficult to snap them up. The compositor has to pry them up, and perhaps to turn them around nick out or head up, before they can be laid in the stick.

The fastest compositors, or those who can be fast when they choose, do not usually set the largest quantity of type in a week. In the long race, the steadier men beat them in performance by their superior persistence. The worst compositors—and all who make foul proofs may be so considered—are usually the greatest talkers at work.

All the material needed for the day should be in or near the case before beginning work. To stop composition to distribute, or to search for leads, quads, and extra sorts, is always a hindrance.

The emptying of composed type in a stick calls for some sleight of hand, at which the young compositor often fails. His fault comes from gripping too tightly the lines between his thumbs and forefingers, and neglecting the pressure of the middle

fingers at the ends of the lines, where pressure is more needed. He should begin by taking out one line only. When he takes up two or more lines, he will soon learn where to apply the pressure and how to balance the type. As soon as the type is



put upon the galley he should press it up with his composing-rule, and leave it standing squarely on its feet.

Making up the stick, or adjusting the stick by its slide and screw to the proper width of a given measure, is a work of exactness that cannot be safely intrusted to a young compositor. When two or more compositors are employed on the same work, their sticks should be made up uniformly. A very slight variation of width in the making up of two or more sticks, followed by other slight variations in justification, will give much trouble when the matter is put on stone or on press. Exactness of measure is best secured by the use of a solid metal gauge, about four picas thick, against which the slide is pushed until it is tight. When a solid metal gauge is not to be had, the width of the measure can be formed from a predetermined

number of large em quadrats, against which the slide must be set tightly. A line of the letter *m*, frequently used, may not be so accurate, for the greater the number of pieces, the greater the liability to inaccuracy from unequal rubbing at the foundry or from the possible bending or corner-bruising of the types. To make up measure with leads and a thin cardboard between the lead and the slide is another unsafe method for any composition in which more than one stick will be used. Making measure by the gauge of dead matter is equally objectionable. A fixed gauge should be used to test the stick as well as to form the measure. If this gauge shows that the stick is tight at one end of the slide and loose at the other, it is not true and should be rejected. Spacing too tight, dropping the stick on the floor, making use of the plate of the stick as a turnkey, are some of the careless practices that make sticks untrue.

1edgē at tpe outset of his practice in type-
s clesn broot must acquire this know-
npside down. The compositor who wants
in this illustration, is a reading of letters
Reading types in the stick, as they appear

The young compositor should read over every line as soon as he sets it, and at once correct any detected error. Before he empties the matter on the galley he should read it again, looking for outs

and doublets. The time given to correction in the stick is not time lost. It is easier to correct there than on the galley or the stone, and it is worth a deal of trouble to acquire the reputation of a clean compositor.

The making of pi is frequently unavoidable. A standing rule in many printing-houses is that pi must be distributed on the day it is made. When the maker of this pi is unknown, it is customary to divide it equally among all the compositors for immediate distribution. The operation of this rule seems harsh, but it is for the common advantage. The small heap of pi that remains undistributed overnight invites more carelessness; it is probable that it will be larger at the end of the next day.

RECENT MANNERISMS

A new fashion in typography directs that the first line of every paragraph, whether at the beginning, middle, or ending of a chapter, shall begin flush at the left side of the measure. The only indication that the line which is so treated begins a new paragraph is to be found in the blank that may be left in the last line of the preceding paragraph. When that line is full, there is no indication, and the two intended paragraphs are made one. For this reason the suppression of the em quadrat as the mark of paragraph indention is not a safe practice. It may be and often is proper enough when

there is a full white line over the first line of any paragraph, but not otherwise. The em quadrat has been for years the established mark of paragraph indention, and it can be omitted with safety only when it is so ordered.

Ragged endings at the right side of all the lines of the text, as is unavoidable in type-writing, is another novelty. This new mannerism lessens the labor of spacing, but it makes an unsymmetrical page that is unpleasing to the reader. Print is preferred to manuscript because it is symmetrical and orderly as well as more readable. To reproduce in print the irregularities of autographic work is an unwise rejection of the uniformity that is the great merit of letterpress printing. Lines of ragged outline may attract attention to an advertisement or an ephemeral pamphlet, but to the reader this raggedness seems slovenly.

Unleaded and thin-spaced composition is preferred by the disciples of William Morris, but it is not liked by the average reader, who does need a perceptible white blank between words or lines of print. During the fifteenth century, when thin leads and graduated spaces were almost unknown and but little used, the reading world had its surfeit of close-spaced and solid type-setting. "It is not probable that readers of this century can be educated to relish a practice that then had no excuse but that of unavoidability." Words can be spaced and lines can be led too widely, but a perceptible break of white between words and lines at least as great as the white between the body-marks or

stems of single letters is needed for easy reading. A solid and very thin-spaced composition may be quite acceptable in the text of types on 14-point and larger bodies, when these types have been properly printed on damp paper, for under these conditions ordinary eyesight can discern the shape of each character, but it is not acceptable in any body of small type that has been printed on dry and coated paper, where the eye has to guess at the words and does not clearly discern the forms of single types.

The dense huddling of lines of capital letters, narrowly spaced and without any leads, and the jamming of text types close against illustrations or up

CAPITAL LETTERS NEEDLESSLY HUDDLED BY THIN SPACING AND OMISSION OF SEPARATING LEADS

to large initial letters or surrounding borders, are equally objectionable. The relation of letters to one another should not purposely be made difficult when they can be composed to be read at a glance. Illustrations of all kinds, whether in the form of diagrams, initial letters, head-bands, or borders, need a decent relief of white to show their value. Ruskin wisely says that "the eye is not saddened by quantity of white, but it is saddened and should be offended by quantity of black." This remark can be properly extended to the mutual interference of bold-faced types, or to decorations of any kind when they crowd too close against letters.

Over-wide spacing of single types, of both capitals and lower-case letters, for the purpose of making the running title of a page or every line in a page of display fill the measure, is another caprice. The advantage to be gained by this explosive treatment of types is not apparent. It is never done in the

T H E O V E R - W I D E S P A C I N G
O F S I N G L E T Y P E S T H A T
D I S L O C A T E S T H E W O R D S
A N D P R O D U C E S C O N F U S I O N

text of a book in short lines of dialogue matter or in poetry. It does not make clearer or more symmetrical the running title or any subheading. It does not add to the comeliness of a modern book, even if it was a style of the seventeenth century.

The uncouth letters now provided by type-founders for display sometimes appear in the subheadings of magazines, but the wise publisher forbids their appearance in a library book.¹ The reader and the student have small reason to complain of any ineffectiveness in the modest types that have been used for years with advantage to make clear the difference between the headings and the subject-matter of a book, and they have good cause to

¹ Advertisers are largely responsible for these letters. They properly represent in type the screaming "barker" before a paltry show, or the "hustler" who breaks up an interview and insists on first and immediate

attention. This new typographic practice of "getting ahead" of all rivals is damaging to the serious book, for it produces the impression that there is probably an inferiority in matter that is heralded by needless display.

protest against rude types that deform printing. The title-page and the subheadings of a book may be judiciously decorated by inclosing their words

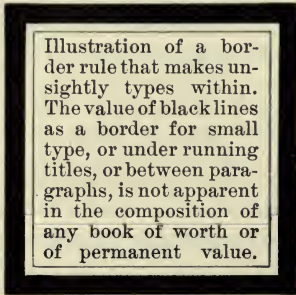

in a rule border or in many panels of brass rule formed of single or parallel hair-lines, but in some instances the rule is of much bolder face than the type within, and more strikingly attracts the notice of the reader.

It often requires energetic protest from author and publisher, the real sponsors of the book, to prevent a young compositor from adorning its subheadings with the twisted and fantastic black borders that are now in fashion in Germany, or from overloading the book with hair-line rules that often have attached scraps of decoration.

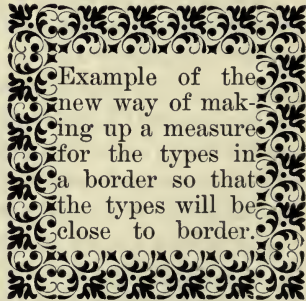

This unwise fondness for ornamentation often induces the amateur to fill the blanks in the last lines of paragraphs or on each side of the running title of a modern

book with petty figments of bordering. There are books on medieval subjects, and some on modern subjects, in which decoration of this kind may be a grace, but it should be selected with caution. In the larger part of modern books so treated, this filling up of all blanks with decoration is a positive fault. Ornamented pages intended for printing in black ink seldom need a border bolder than the types within. It should not be necessary to repeat the platitude that the book is bought to be read for the thought of the author and not to see the fancies

————— REMARKS —————
 ————— ON THE —————
 ART OF MAKING DISPLAY EXTREMELY
 ————— DIFFICULT AND EXPENSIVE —————
 ————— WITHOUT —————
 ————— IMPROVEMENT TO ITS CLEARNESS OR BEAUTY, ———
 ————— AND VERY MUCH TO THE DAMAGE —————
 ————— OF ITS SALABILITY —————

of the printer or decorator, but it seems to be needed. A young compositor should always observe this rule of all architects: "You may ornament construction; you must not construct ornament." Types that represent words and thought must have first place; ornamentation of any kind should be subordinate.

These mannerisms have been introduced during the last twenty years. It is not unsafe to hazard the assertion that before another twenty years has passed they will be out of fashion, and the book containing them will be in lasting discredit.

When a printer is plainly directed to make use of one or more of these mannerisms, he should do so without question or remark, for it is his plain duty to do what he is told, and to do it intelligently and helpfully, whether he does or does not like the style; but when he has a free hand and is asked to do the composition of a new book in workmanlike manner, he will make no mistake in adhering to methods of simplicity that have prevailed for centuries. It will be safer to accept the leadership of Bodoni and Didot, of Pickering and Whittingham, than that of many recent reformers of typography.





HENRY O. HOUGHTON

IV

COMPOSITION OF BOOKS

Title-page . . . Preface matter . . . Chapter headings and synopsis . . . Subheadings . . . Extracts . . . Notes and illustrations . . . Running titles and paging . . . Poetry Appendix and index . . . Initials . . . Head-bands, etc.

TITLE-PAGE



ROMAN capitals of regular form in uneven lines of open display are preferred for the title-page by the largest number of publishers. The lower-case of roman and italic and the capitals of italic are other tolerated styles, but title-pages exclusively in any one of these series are not common. A title-page in roman capitals displayed in a plain manner is most satisfactory for the ordinary book, and it is for the plain title

only that these brief remarks are made. Properly selected, their arrangement gives least trouble to the compositor.

The type of the title should be of the same face as that of the text. This is easier said than done, for there are few text types provided with larger sizes of precisely the same face and fitted for words and lines of different length. The compositor must do the best he can with the faces and styles that are available, but he must avoid harsh contrasts. He should understand at the outset that his composition will be most satisfactory when the types selected show mutual relation. Even one line of italic capitals in a composition otherwise of roman capitals only will make discord. A title-page may be entirely in capitals or entirely in lower-case (initial letters excepted), either in roman or italic, but two series can seldom be used together.¹

The copy for title-page matter should be studied before the first line is put in type. The compositor should predetermine how many lines and how much

¹Exception may be allowed for a word that calls for peculiar emphasis, for honorary titles in separate lines, and for a line of display with arabic figures. Small capitals that are almost unreadable may be supplanted with small but more readable lower-case. Real old English black-letter of large size may be selected, in a title-page otherwise of roman capitals only, for

the name of a book that treats of old English literature, but it is not pleasing in an imprint or for any other short line. The uniformity of face that is the great merit of a page of text should be maintained in a page of title. To mix two faces destroys the bookish feature; it degrades the title to the level of a newspaper advertisement or a handbill.

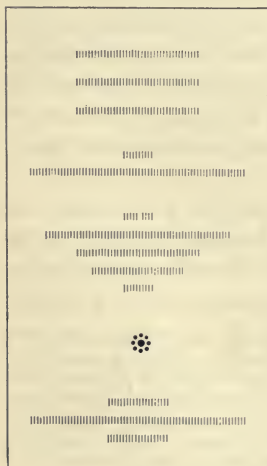
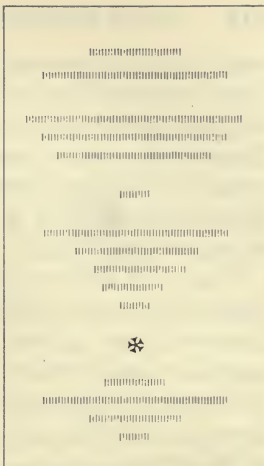

Suggestions for sketches of titles.

blank between lines are really needed. He should begin by sketching on a bit of paper the relative size and length of the proposed lines. The first lesson to be learned by him is that the attractiveness of a title-page depends as much on the proper distribution of blank space as on the proper display of important words.

Blanks of different widths are needed between distinct divisions of subject-matter—a broad blank between those that are not closely related, and a narrower one between those that are. To display the matter in the manner of a handbill by making frequent catch-lines and putting blanks of the same width between all the divisions will spoil any title. The broadest blank in titles without device or illustration should be above the publisher's imprint. Catch-lines have to be selected for some title-pages, but they should not be too frequent or in too small type. When it is possible to do so, all the words in a title-page should be in types that are as readable as those of the text.¹

An old method of constructing a title-page, not yet out of fashion (usually done in obedience to order of author), was to plan it with many distinct lines, and to crowd the long name of the book in

¹ Large type is not possible for prolix honorary titles, nor for some details added by the publisher, but it is practicable to make all important words noticeable. Pettiness should be avoided as much as overbold display. The strong contrast produced by putting a catch-line of small capitals of nonpareil above or below a large two-line letter, once a grace, is now a real fault. The reader values readability more than he does ingenuity.

one bold line of condensed type. The short name had its types spaced out to fill the line, for a full line was rated of first importance. These methods did not always give to the title the desired boldness and clearness; in many books they made it feeble and incoherent. A contrast of the old with the new method of treating the title is presented on the following pages.

The name by which the book will be identified should be the boldest line, and the words for this line are usually prescribed by the author. As this line determines the size of other lines, it should be the one first set. Its length or shortness is not of first importance, as is often supposed, but its boldness is: it should be bold enough to arrest attention at the first glance. Condensed types have to be selected for this line when the author insists on putting many words in one line, but this shape of type should be avoided when it is possible. Types slightly compressed are tolerated by the critical, but not when they are visibly pinched. At their best when their letters are not spaced, they are never entirely pleasing either for a scant or a crowded title. A two-line type of the standard or regular width is clearer than a condensed type of greater height, and should be preferred.

When the letters for the main line of display are few, they may be in one short line, but when there are too many for one line, and condensed letter is forbidden, they may be arranged in two lines. The

A HISTORY
OF
CLASSICAL GREEK LITERATURE

BY THE
REV. J. P. MAHAFFY, M.A.

KNIGHT OF THE ORDER OF THE REDEEMER
FELLOW AND PROF. OF ANCIENT HISTORY, TRIN. COLL. DUBLIN
HON. FELLOW OF QUEEN'S COLL. OXFORD
AUTHOR OF 'SOCIAL LIFE IN GREECE' 'PROLEGOMENA TO ANCIENT HISTORY'
'GREEK LIFE AND THOUGHT' 'RAMBLES AND STUDIES IN GREECE'
'THE GREEK WORLD UNDER ROMAN SWAY' ETC.

IN TWO VOLUMES

VOL. II. PART I.
THE PROSE WRITERS
FROM HERODOTUS TO PLATO

THIRD EDITION, REVISED THROUGHOUT

London
MACMILLAN AND CO.
AND NEW YORK
1890

All rights reserved

A HISTORY OF
CLASSICAL GREEK
LITERATURE

BY THE
REV. J. P. MAHAFFY, M. A.

Knight of the Order of the Redeemer; Fellow and Professor of Ancient History, Trinity College, Dublin; Honorary Fellow of Queen's College, Oxford; Author of "Social Life in Greece," "Prolegomena to Ancient History," "Greek Life and Thought," "Rambles and Studies in Greece," "The Greek World under Roman Sway," etc.

IN TWO VOLUMES. VOLUME II. PART I.

THE PROSE WRITERS
FROM HERODOTUS TO PLATO

THIRD EDITION
REVISED THROUGHOUT

LONDON
MACMILLAN AND CO.

AND NEW YORK

1890

All rights reserved

two lines so picked out should be of the same face and nearly, if not exactly, of the same size. They should not be huddled: the blank between them should be about as wide as the height of the type selected.¹ If these meeting lines are of the same length, the letters of one line may be thin-spaced to make it a trifle longer, but the spacing should be slight, so that its increased width will not be at once apparent.² The main line is well placed when it appears as the second or third line on the page. A title with its largest and longest line at the top of the page is always unbalanced and top-heavy. When copy will allow, the introductory article THE or A may be the first short line.

¹ This suggestion opposes the practice of some designers who separate lines of large letters with very thin lanes of white space. This is often done even when there is abundance of unfilled space in other quarters of the page. Letters so treated would be more readable if they were shortened in height and more blank were put between lines. The eye has been accustomed to seeing in roman lower-case type decidedly greater relief of white space above and below each line than there is within the letter. This relief of white space is equally needed for capital letters; they need as much space without as within.

² The first line may be long and the second line short, or vice versa, but it is desirable that

words closely related in sense shall be kept in the same line. It is not always necessary that two meeting lines of display shall be uneven as to length. When the words in the lines are of equal importance, they should be treated in the same manner, and be spaced or unspaced to have equal distinction, even if they are of the same length. Two contiguous short display lines of equal length are not a fault, but the display will be faulty if one line is purposely made too large and the other too small. The old rule that required a bold full line to be followed by a short inconspicuous line, even when it gave false value to the words of the author, is not observed now by the discreet publisher.

THE
GRAMMAR
OF
ENGLISH GRAMMARS

FIFTY YEARS AMONG AUTHORS,
BOOKS AND PUBLISHERS

THE ART OF ILLUSTRATION
The Art of Illustration

A
SENTIMENTAL JOURNEY
THROUGH
FRANCE AND ITALY

CRITICAL AND MISCELLANEOUS
ESSAYS

ONE HUNDRED BOOKS
FAMOUS IN
ENGLISH LITERATURE
WITH
Facsimiles of the Title-pages

Old method.

THE
GRAMMAR OF
ENGLISH GRAMMARS

FIFTY YEARS
AMONG AUTHORS, BOOKS
AND PUBLISHERS

THE ART OF
ILLUSTRATION

A
SENTIMENTAL JOURNEY
THROUGH FRANCE
AND ITALY

CRITICAL
AND MISCELLANEOUS
ESSAYS

ONE HUNDRED BOOKS
FAMOUS IN
ENGLISH LITERATURE
WITH FACSIMILES OF
THE TITLE-PAGES

Modern method.

120 *Expression of words of first importance*

It is sometimes difficult to compose in an orderly manner the words prescribed when the author requires them in one full line. If the letters for this line are too few, a type unduly large must be used. If smaller type is selected, the line will be short and feeble and the letters must be spaced, but spacing to full width of measure will make the line still feebler. Attaching a large capital of the same face as an initial letter will make it practically a line of capitals and small capitals (never pleasing in a title-page), that does not materially increase its boldness. Nor is a large engraved initial of square form helpful; most serviceable at the head of solid text type, it always seems discordant and out of place in the open title-page.

If the letters in the line are too many, condensed type must be selected, but pinched letters make a discord with those of standard width. When two letters only of a type of proper size and shape will not come in, the measure should be widened to take them in. If this is not practicable, set the words in two lines. When types have been chosen of a size to give a proper showing to words, irrespective of the length or shortness of lines, and other details of composition are fairly adjusted, the result will seldom be unsatisfactory. Old-fashioned rules about display often have to be put aside. They should not be maintained when they produce mean display. It is of first importance that the words in a title be properly presented, even if the old rules are violated.

The copy for a title-page may specify for its main line not one, but four or more distinct words, all of equal importance and all requiring equal prominence. It may be impossible to give them proper prominence in one line or even in two lines. By old methods words of this description were set in two lines—the first line in a very large type, and the second in a smaller type, after this fashion :

A CRITICAL REVIEW
OF
PAINTERS DESIGNERS
ETCHERS AND ENGRAVERS

The only excuse for making this needless distinction in the size of type is the unreasonable rule that required two meeting lines to be unequal in size and in length. The new method of treating these words for display is simpler, much less troublesome, and more satisfactory to the author.

A CRITICAL REVIEW OF
PAINTERS
DESIGNERS
ETCHERS AND
ENGRAVERS

This treatment gives equality to all the words, and the initial letters of each word line vertically, regardless of their irregular endings.

All other short lines of a title-page can be centred by putting equal blanks on each side of every line. The needed irregularity is produced by different sizes of type that make the lines of unequal length, but there should be some symmetry in the apparent irregularity; a pencil line drawn diagonally from the end of a short to the end of the longest line should touch or nearly touch the ends of the intermediate lines. A hair-spacing of one or more intermediate lines may be needed.

When the main line has to be widely spaced, as in a title-page of the Puritan or seventeenth-century style, other lines of display should be wide-spaced, and broad blanks put between the lines above and below the main line. The space between single types in any line of display should be much narrower than that of its proximate blanks. The wide spacing of single types when there are narrow blanks above and below is unpleasing, for it makes the subject-matter incoherent.

Small capitals that have little interior white space may need hair-spacing to make them more distinct. An old rule required every line in the title to be spaced when the main line had been spaced. This treatment is not always practicable, but it could be observed much oftener than has been done, and with advantage to many title-pages.

Lines of secondary display should not be frequent, nor set in types so large as to reduce the importance of the main line and to encroach on the wide blanks that are needed between the regular divisions. Grouping of details in a synopsis under the name of the book in readable capitals, and in short lines of a squared form or in a diamond or half-diamond arrangement, is the more approved practice. The attractiveness of a title-page is largely in the visible coherence of its words. Wide blanks that separate divisions not closely related, and narrow blanks that combine those that are related, are greater aids to a comprehension of subject-matter than many lines of bold type.

The names of author, editor or translator, and designer may be in types of graduated size to indicate the relative value of their contributions, but to preserve irregularity of outline it may be necessary to neglect the nice distinctions intended to be produced by different sizes of type. A general effect of irregularity should be maintained even if those distinctions are not at once noticeable and some lines are made a trifle short or long.

Arabic figures must be avoided in all lines of capitals. Figures of old-style face are always mean mates in the same line with their broad and tall capitals, nor is any figure of modern cut on the en body pleasing in a line of capitals of regular width. Roman numerals or spelled-out words are imperative in lines of capitals for all amounts but

those of dates, yet the date following a publisher's imprint, always in a separate line, may be in arabic figures with propriety.

When the title-page is crowded with much matter, the prefixed BY before the name of the author may be set in the same line and in the same type. Abbreviations of short honorary titles following the name may appear with that name in the same type and same line, but when there are many honorary titles this prefixed BY has to be in a separate line. Honorary titles are not pleasing in small capitals by the side of the name; they may be spelled out, to appear in a separate line below the name, in small capitals or in two or more lines of small lower-case. Spaces are not needed after the periods in abbreviations like A.B. and LL.D. Custom requires the name of the author to be in larger type than that given to his coadjutors, but there may be special reasons for neglecting this practice. When superior distinction is required for an illustrator, editor, or translator, his name may be larger, or even appear in small type as the first line of the page.

The motto of a title-page always seems in the way. It must be placed where the author directs, but if put as is usual in the middle of the page, it may need a hair-line dash above and below to separate it from other parts of the title. When the title is crowded, and the author permits, it may be put at the head of the page or on the leaf that precedes or follows the title-page. One or two

lines of a motto may be in small capitals ; three or more lines are better in small lower-case letters. It always appears to better advantage in a purposely narrowed measure, but modern practice does not inclose it in a border-line.¹

Curved lines, ornamental dashes, a sprinkling of odd initials, or decoration of any description, should never be added to a title without order.

The Morris title is made by crowding at the head of the page all its words in a few lines of thin-spaced and unleaded capital letters. It is not a modern but an old method, apparently devised by an illuminator who wanted nearly all the page for his own handiwork. When the blank so made is not filled with decoration, the page is unsightly.

Explanations concerning the publication of the book and specifications about the edition, as of the number of copies printed, are usually put on the title-page, but these additions always prevent orderly arrangement. A displayed title-page overcrowded with lines that must be read more slowly and thoughtfully than lines of the text matter is a

¹ Two or more long quotations selected to serve for the motto should be put on a separate page, and roman lower-case of a small size is usually selected for this purpose. It is not necessary that the lines of a motto should be the full width of the measure ; it is always more pleasing when its first and last lines are full. This may compel frequent overrun-

ning, but the ungainly appearance of indented and broken lines will be prevented. When two or more distinct quotations appear on the same page, they may be separated by a white line, not by dashes. The reference to the book from which the quotations have been taken should be in a separate line, in smaller type, and not preceded by a dash.

mistake. It should be so composed that the hasty reader can take in its full meaning at a glance.¹

The title-page of but few lines that presents a ragged and meagre appearance may be improved by inclosing it in a brass-rule border of parallel hair-lines or of one firm line about one point thick. The bold-faced rule with face much thicker than the stem of the largest type in that title is not to be commended, for it makes the words within seem insignificant. The single hair-line border is equally objectionable, for it is feeble and is electrotyped and printed with difficulty. Putting title matter in two or more panels of brass rule may or may not be an improvement; it is always a hazardous experiment that may degrade the title instead of improving it. The wishes of the publisher should be consulted before this experiment is tried.

Some title-pages have their words and phrasing so arranged that they are difficult to put in type in

¹ No part of the book is subjected to more capricious treatment than the title. Although the largest number of publishers and readers prefer the plain title, there are others who ask for black-letter with medieval mannerisms, or for eccentricities of arrangement with brass rules and grotesque types. To give directions or even suggestions for the composition of the fantastic title would be useless, for the lover of novelty too often wants his title-page in a style that is entirely new. For com-

position so ordered the compositor can do no more than follow specific directions given by the author. Even when it is requested that a new title-page shall be in imitation of a given model, it is seldom that the words to be used (which may be too few or too many) can be accommodated to the style of that model. The fantastic composition that may be admired in an old book or in the pamphlets of advertisers always seems out of place in any book of permanent interest.

an orderly manner even when they receive the benefit of suggestions from the author and the advice of experts. Every attempt at improvement seems to make them more unpleasing. To prevent this disappointment the abandonment of display is advised. Set the matter in large type (all capitals, all italic, or all lower-case, as may seem best), in half-diamond indention, after the methods of the early printers, or as a plain paragraph with hanging indention. When this can be done without gross faults of spacing or in the division of words, the result will seldom be unsatisfactory.¹

DEDICATION

The dedication is not a necessary part, and is now seldom required. When used, it is put on a separate leaf with a blank verso, and is oftenest set in small capitals with all its lines centred, as is done in the displayed title-page, with large capitals only for the name of the person to whom the book is dedicated. It is never improved by types of eccentricity. The matter is usually divided into lines of unequal length, as may be directed by the author, but it is most satisfactory when it does not show a marked irregularity in the length of proximate lines. The short line of one or two words only,

¹ For additional remarks on the selection of types and the composition of title-pages, see *A Treatise on Title-pages*, which also contains many illustrations of titles set in different faces of type and in the fashions of different periods.

following or preceding a line the entire width of the measure, destroys symmetry in composition. A long dedication can be made more readable by setting it as a letter in italic lower-case.

TABLE OF CONTENTS

The table of contents, usually on a separate leaf, is often set in small capitals one or two sizes smaller than the type of the text, with capitals for the first letter of important words, but roman lower-case is sometimes preferred. Small capitals of the large type of a text are not a good choice, for they make the page seem needlessly coarse. The number of the chapter, the name of the chapter heading, and the page figures referred to, appear at their best when they can be put in one line. This line should begin with the number of the chapter in roman numerals of small capitals. The initial letters of the chapter should be kept in a vertical line.

A table of contents needs wide leading to make it readable. When the subjects provided fill the page too compactly and leave insufficient blank at its head, the matter should be double- or treble-leaded to occupy two or more pages. This leading should not be strictly uniform, for when the words of a chapter name make two or more lines they should be kept visibly together, separated by one lead only, even if three leads or white lines are put between the matter provided for different chapters.

When other parts of the book are wide-ledged, and it is desirable that the contents should occupy two or more pages, the numerals that define chapters may be put in a separate line in the centre of the measure, and there should be still broader blanks between the names or legends of the chapters. This treatment should not be attempted in any book with solid text, for some uniformity of compactness or of openness should be maintained throughout the fore part of the book. When the words of a chapter heading are many and make a second line, the two lines may be braced and the page number put at the point of the brace, but the brace selected for this purpose should not be blacker than the type of the text. The leaders provided by the type-founders to connect letters with figures are not so pleasing as periods placed one em apart.

TABLE OF ILLUSTRATIONS

This table, more irregular in its matter than the table of contents, usually contains in its first line the legend of the illustration, and near its ending the name of the designer, engraver, or photographer. Under the legend line are often put one or more lines of added explanation, which may be in small type. When space and matter will permit, an attempt should be made to keep the names of the artists in vertical line, so that the casual reader will note the distinction. Not a little ingenuity

may be required to keep the matter straight. The lines may have to be reset repeatedly before the composition is presentable.

PARTS AND HALF-TITLES

Each large subdivision of book or part or canto takes a separate leaf in the sumptuous volume, and its name or number is put in the centre or a little above the centre of an otherwise blank page. The back of this page is always blank. The type that defines the part need not be large. Roman numerals are used to specify its number, but to give it a due prominence and equality with the wider and bolder capitals in that line, the thin types for numerals II and III will need a thin space between them.

For the cheap edition a separate leaf for each part is not often allowed. The number and name of the part may be ordered to be put at the head of its following chapter page, and if that page has a long synopsis, a hair-line dash may be needed under the line that specifies the part, but the dash should be suppressed when the relative importance of the different headings can be made clear without it.

The half-title, which is a repetition of the name of the book, was once put over the first chapter of every book, but it is rarely used now.¹ When a

¹ The half-title should not be confounded with the bastard title. The half-title follows the title and begins the first page of text; the bastard title, usually a single line in capital letters, precedes the full title, and takes a separate leaf with blank verso.

head-band, an engraved initial, and a long synopsis have to be inserted, the half-title is impracticable.

CHAPTER HEADINGS

A crowded first page is as unsightly as a crowded title. If it contains head-band, half-title, number of chapter, chapter heading, synopsis, subheading, and initial, the first page cannot be composed in orderly manner, with proper subordination of types to show their distinction.

The number of a chapter heading is usually set in capitals of the text type, but the numbers only may be larger. As the numerals I II III are thin and relatively insignificant by the side of the letters in the word CHAPTER, that word is often omitted, and the chapter is defined by numerals only. The head-band that surmounts a chapter heading may be sunk two lines, so that its top will register with the first line of text on the following page, and not with the running title. If the text is wide-leaded, about half a page of blank space may be given to the chapter heading; if thin-leaded, one third; if solid and without a head-band, one fourth or one fifth of the page.¹ The space allowed for the first

¹ The amount of blank often has to be governed by the amount of matter in the synopsis that may follow, and by the size of the initial letter, if an initial is used. There should be at least two and preferably four lines or more of text below the large initial. The synopsis is a disfigurement when it overruns on the next page and prevents needed lines of text on the first page.

chapter heading may be used for all the following chapter headings, and should be distinctly marked on the gauge of the maker-up.

The type for the words that give name to the chapter (which should be the same in all the following chapter headings) may be in capitals of the text type, or larger, if its letters will come in one or two lines. If its words are too many for one line, do not select black-letter or any form of condensed type; make two lines of the matter, but shorten the first line and place the overrun words in the centre of the second line. The words in this first line need not fill the measure. To make the first line full, and to put in the second line one word or syllable only, will be a great blemish. When there is no synopsis, and the name of the chapter will make more than two lines, do not use capitals: small capitals or italic lower-case will be a better choice; and the lines may be arranged in hanging indentation or in half-diamond shape.

SYNOPSIS

This abstract of the contents of the chapter is often set in small capitals of the text type, but in this position the small capitals of a large body show too much space between lines and seem needlessly large and coarse. Small capitals on a body two or three sizes smaller than that of the text are a more approved selection, although they are dense

and too often indistinct. A small size of plain roman lower-case is more acceptable. It must be set in small type when it crowds the space needed for the initial letter and the text type. Sentences in a synopsis are often separated by an em dash, but the period before the dash is not needed; a thin space before and after is better. Two or three periods a thick space apart and without any dash make a more pleasing mark of separation. The synopsis is usually set in hanging indention, which should not be greater than that of the paragraphs of the text. Indentions of three or more ems make the matter lopsided.

The long synopsis, in lower-case italic, with its clauses separated by semicolons, is sometimes put on a separate leaf with blank verso before the chapter.

PREFACE AND INTRODUCTION

The size of type for preface and introduction is frequently determined by the author. When the printer has the right of choice, and space will allow, the preface may be in large type, or in the type of the text made distinctive by a change in its leading. A book on a bibliographical subject may have its preface in italic lower-case, as was once customary. As the preface often contains more or less of personal explanation, it needs some distinction of type, which can be varied to suit the occasion. When these personal explanations are

of minor importance, and the matter for the text has exceeded its intended limit, the preface may be in small type. A book of many editions may have as many distinct prefaces, and it is the general practice to give to each one its beginning on an odd page, even if this treatment makes many blank pages. A short preface is pleasing when in large type, but large type is seldom ordered when the matter will make many pages.

The long introduction is often set in smaller type and with thinner leads than those for the text, but its type should be of the same face and have similar treatment. A solid introduction before a leaded text is unpleasing. When head-bands have been selected for the regular chapters, a head-band may be used for the first page of the preface or introduction, but it may be narrower than the head-bands of regular chapters.

As the preface and introduction are usually set after the text has been printed, it is necessary to give them separate paging with numerals of roman lower-case. The roman numerals need not be used for any reprint on which presswork begins with the preface.

Careful composition is of importance in the first part of the book, for a neglect in workmanship is there most noticeable. The sumptuous book must have its chapter headings begin on odd pages, but in a book without pretence to superiority each new chapter may begin on the verso, or left-hand page.

The publisher may not consent to what he calls a needless waste of white paper. In some books the chapters are as brief as they are in the Bible, under which condition the new chapter must closely follow the previous chapter. To prevent unsightly gaps of white space, it is often necessary to overrun many pages previously made up. Paragraphs must be made longer or shorter by a wider or narrower spacing of lines, and an unequal amount of blank must be put between the chapters. Hymn-books and collections of desultory poems in different measures often require similar treatment. No fixed rule can be laid down for the amount of blank between chapters, but it must be large in the sumptuous and small in the compact book.¹

SUBHEADINGS

Subheadings, of the same class, intended to relieve the monotony of plain type, should be in the same face and size of type throughout the book. For a subheading of one or two lines only, the small capitals of the text are commonly used. For subheadings of three lines or more, italic lower-case of

¹ The rule that requires every chapter heading to begin on the odd page often meets with unexpected difficulties. The end of a previous chapter may overrun three lines on an odd page, leaving the lower part of that page and the page following en-

tirely blank. The proper treatment of this difficulty will be considered in a future chapter on making up. The intervention of the author or publisher may be needed to add or cancel matter enough to make a sightly page.

the text in hanging indention of one em only will be a better choice. The indistinctness of compact small capitals can be made less offensive by hair-spacing the letters, but this treatment is not recommended for subheadings of more than one line. If the italic of the text is not large enough, use the next larger size. The subheading in italic is also used in school-books or any didactic work containing rules or propositions that serve as texts for following remarks. In school-books these subheadings often appear in light-faced antique or title type, but this overbold display is not to be recommended in the standard book. The distinction desired for a subheading is secured more effectively by putting about it a generous relief of white space. In some books long subheadings are set in lower-case type two or three sizes smaller than that of the text. Small type and abundant white space about the subheading are enough to arrest the attention of the reader.

Paragraphs below the rule or proposition that serves as a text are often numbered or lettered, but the number or letter need not be inclosed in parentheses that lessen its prominence. Old-style figures are objectionable, for they are weak and of irregular form. The number or letter need not be followed by a period. The en quadrat is enough to show separation, as in the versification of the Bible.

Side-headings may be set in small capitals or italic, but they do not need an em dash to follow the

closing period. For dictionaries, gazetteers, or work of like character, that contains frequent paragraphs, the side-heading of title or antique type is preferred. It is not necessary that the type for this purpose should be very bold, nor should it have marked eccentricity of shape to annoy the critical reader, but it will present a much neater appearance when it is on line with the type of the text.

Copy is sometimes formally divided into paragraphs and sections, and the signs for these divisions may be ordered instead of spelled-out words. The sign should be separated from its following figure by a three-to-em space. The abbreviation of SEC. for Section is not wise. If space has to be saved, the sign § is better.

EXTRACTS

Extracts and notes should be leaded when the text is leaded, but always with a thinner lead for each decreasing size. The text that has six-to-pica leads should have its extracts in type one size smaller with an eight-to-pica lead, and the notes at the foot of the page should have a ten-to-pica lead.

Short extracts and quotations may be run in the text and yet be kept distinct by using the ordinary marks of quotation. When there are four or more lines, the quoted matter can be more distinctly defined by putting the reversed commas at the beginning of each line, and apostrophes at the end

of the last line, but this old fashion is used now only when extreme precision is compulsory. The approved practice is to set extracts of four or more lines in type of the same face but one size smaller than that of the text. Types two or three sizes smaller are objectionably petty.

When the extract is set in a separate paragraph and in smaller type, it does not need the marks of quotation; the change in size is a sufficient indication of a change in authorship. A new method of indicating extracts indents them one em on each side of every line. Long extracts that make two or more pages are frequently an annoyance to the reader. When it can be done, the verbose extract should be remanded to the appendix.

Extracts in prose or long quotations of poetry in smaller type are kept separate from the text by leads placed above and below. If the text is solid, two leads may be enough to mark this separation, Italic is occasionally selected for poetry, but not to advantage. To prevent the overrunning of very long lines of poetry, always a blemish, a smaller size of type may be selected.

If the extract has been ordered in peculiar type or in the style of a document, it may be inclosed in a rule of hair-line face, which will show that it is an illustration as well as an extract. Another way, more generally pleasing and not so troublesome, is to begin the document with a plain two-line letter, which clearly shows that it is not a part of the text.

NOTES

Foot-notes usually appear in a type two or three sizes smaller than the type of the text. Four sizes smaller, but not less than 6-point, may be a better choice when notes are prolix as well as profuse. When the note is merely the specification in abbreviated words of an authority, it may be set in broad measure; when it is explanatory and makes many lines, half-measure is better. The two columns of this half-measure will be properly separated with an em quadrat of the type of the note. A brass rule to separate the two columns of a half-measure note, or a broad-measure note from the text above, is seldom used now.

Side-notes in type three sizes smaller than that of the text are usually made up to a measure of eight nonpareils, but they may be wider for notes that have many words. Sometimes specifications of authority are set in italic lower-case type, but italic is not a wise choice, for its kerned letters are easily damaged in this exposed position, and the upright arabic figures too often used with it do not accord with inclined letters.

Cut-in notes are in measures of variable widths, and they usually appear in small sizes of plain roman lower-case type. Light-faced antiques and condensed letters are common in the texts of school-books, but are not a betterment to a library book.

A modern fashion for cut-in notes is to begin them on the first line of the paragraph, but this treatment gives to that paragraph a ragged and unsightly outline. The page will be more comely if the first line of the cut-in note is opposite the third line of the paragraph.

ILLUSTRATIONS

Engravings on wood have practically disappeared. Plates of zinc or copper etched by photo-engraving process now contain the illustrations provided for printing with type. With the providing of these illustrations, mostly furnished by the publisher, the printer has little to do, but to some extent he is made responsible for their proper appearance in print, and it becomes him to examine the plates critically, for the photo-engraver's proof on coated paper may be deceptive.¹ The plate to be examined should be proved again on paper that must be used in the proposed book, and this proof will show whether the plate is or is not proper for the paper. Common faults in process plates are lines broken or thickened at their extremities, shallow etching, and imperfect blocking. These process plates are

¹ Photo-engravings by the so-called half-tone process should never be selected for type-work that must be printed on paper with a dull or rough surface or that has to be dampened before

presswork. Much as it may be disliked by the critical, a supercalendered or a coated paper is needed for the full development of the delicate work of a half-tone plate.

often blocked on wood, but the wood may be soft, warped, too high, too low, out of square, or an insecure support for its plate. These defects must be amended before fair presswork can be done, and the amendments should be made before the plates are sent to the press or to the electrotype foundry. Hard type-metal is better than wood for a base. The cut of irregular shape should be nicked for the admission of type before it is given to the maker-up.

Illustrations (or cuts, as they are oftener called in the printing-house) that come within the measure can be placed by the compositor in their proper order on the galley that receives his composed type, but this cannot be done when the cuts are small or of irregular shape, and the types have to be rearranged to conform to their irregularities and kept within the limits of the page. No one can foresee where the cuts will have to be placed. Lines of type can be divided almost anywhere at the end of the page, but the cut must be intact. It is customary to set the type of every book to be illustrated to the full width of the regular measure, and to have the maker-up put the cut in its proper place after he has divided the type matter in pages. To do this neatly, the type previously set by the compositor must be overrun and led down in a narrow measure by the side of a small or diagonal cut, and this overrunning may have to be done repeatedly before the type and cuts are fitted to each other and to the page.

RUNNING TITLES AND PAGING

Small capitals of the text type, often thin-spaced, with arabic figures in the same line, have been for many years an approved form for the running title, but they are not in high favor now, largely on account of their pettiness. When the words for the running title are few and repeat the name of the book or the heading of the chapter, roman capitals of full size on a body one or two sizes smaller than that of the text are often selected. If it has many words and defines the contents of its page, italic lower-case is to be preferred. A line in italic capitals only is not so well liked. Small capitals of the text can be used when the type of that text is large, but if the text is small and leaded, its small capitals will need hair-spacing, and its paging figures will be indistinct. Old English black-letter is sometimes used for the running title, but this style is at its best in a medieval or bibliographical book. A large size of roman lower-case letter is another approved style. The running title in mixed capitals and small capitals is not a favorite.

To prevent capricious changes in the capitals of a running title in lower-case, capitals should be confined to the initial letter and to proper names.¹

¹ The earliest printed books had no running title or paging figures. The first attempt to supply this need of the reader was to repeat the number of the proper chapter at the head of each page, and this treatment was then supposed to meet all requirements.

The running title is in an exposed position where it first shows the wear of the press. To withstand this wear, school-books, hymn-books, and all works frequently reprinted from plates often have running titles in capitals of light-faced antique.

A new fashion in running titles is the very wide spacing of their letters. This must be done when it is so ordered, but a spacing of single types with em or two-em quadrats is no grace to leaded and a real blemish over a text of solid composition.

The running title is usually separated from the text below by one line of the quadrats of the text type, but if that text type is of 12-point the blank so made will seem needlessly wide. A new fashion separates the running title from its text with two leads only, which may be satisfactory for solid, but is not pleasing for leaded matter.¹

Lower-case type of small size has been used for running titles, but the general preference is for a type larger than that of the text.

Sometimes the running title is not centred, but is set flush up to the inner margin of facing pages, at the end of the left and at the beginning of the

¹ The blank space under the running title seems to invite a meddling treatment. The hair-line cross-rule, sometimes of half the width, but oftener of the full width of the measure, is the favorite, but parallel rules of full width are almost as common. For the page intended to be remarkably spruce, a thick double rule has been used. The value of these additions to the page is not apparent, for a succession of unmeaning rules soon wearies the reader. For this purpose the hair-lines, as usually made upon single, parallel, and double rules, are annoyances to the electrotyper and pressman, and of small benefit to the reader.

right page. The chapter and the section of the book may be specified in the running title,—the chapter name on the left and the section on the right page,—each fenced off from the words of the running title with brackets. This revival of an old fashion is now a common practice, but it cannot be considered as a grace to any modern page.

The running title that consists of the very long name of the book is sometimes divided so that one half only of this name will appear on one page and the other half on the facing page. Nor is this a commendable fashion, for a line of many words can seldom be evenly divided; if it is not so divided, one heading will be longer than the other.

The continuous repetition of the name of the book in its running title, when that name is well known to the reader, is a wearisome and needless formality. This title is most useful when it explains or to some extent defines the matter on the page, and this explanation should refer not to the first but to the last paragraph on that page.

In pamphlets or books that have no running title, the paging figure is put in the centre of the head-line, but it need not be inclosed in parentheses or brackets, nor have attached colons, dashes, or any other attempt at finish. If the first line of type contains nothing but the paging figure, this first line and the blank below it must be reckoned in the imposition of the form on the stone as a part of the head margin of the page. If these practical

blanks are reckoned as a part of the page of type, the margin at the head will seem much too large in print, and the page so treated will have an unworkmanlike appearance.

Old-style figures are disliked for paging. The irregularity of petty types like 101 on one page and 396 on another is offensive to every reader who respects symmetry and uniformity. Some typefounders have remodelled these figures and made them uniform in height and line.¹ It is the rule now that figures for paging should not be smaller or less distinct than the figures used in the text. They should be of readable size, even if it is necessary to justify in the line figures of a larger body.

Paging figures at the head of a full-page cut are forbidden by artists and editors as derogatory to its intended effect. It is, however, necessary that this page have its proper paging figure to prevent

¹ One of the novelties of reformed typography is the omission of all paging figures, both at the head and at the foot of the page. This omission gives needless trouble to the folder as well as to the reader. Paging figures are guide-posts that prevent the folder and binder from making crooked folding and irregular margins. Paging at the foot of the page is a common, and in many instances an unavoidable, practice. In this position the figures may be of small size, but they should be of a face that will enable the gatherer of the sec-

tions to distinguish them from the figures of the regular signature. The proper page figures should be put at the foot of every page that has a lowered chapter heading or a cut at the head of the page. It is a mistake to assume that the early makers of books did not number or letter the leaves of their books to show their regular sequence. William Blades, a most diligent searcher, has shown that the leaves were numbered or lettered at the foot and that their marks were trimmed off after all the leaves had been gathered and sewed.

a possible mistake by stoneman, proof-reader, or pressman. The maker-up puts it in the foot-line, and there it remains until ready for press, when it is withdrawn by the stoneman. If the page is to be electrotyped, the paging figure remains, but the proof-reader marks it to be cut off the plate by the electrotype finisher. He scratches or engraves the proper page figure on the plate so that it will not appear in print, yet will serve as a guide to the pressman. This precaution will prevent delay and annoying blunders in laying plates.

As a rule, paging with arabic figures begins with the text of the book. The matter before the text (as the title, preface, introduction, etc., which are printed last of all) is paged with roman lower-case numerals. This paging is supposed to begin with the bastard title or the first printed page of the book; but neither on that nor on any other very open page are these roman numerals printed, yet they are always reckoned in the table of contents as if they had been paged.

Appendix, index, and all additions to the text take arabic figures for paging, but publishers' advertisements at the end of the book should receive their special paging in a figure of different face. Maps, portraits, and illustrations made on separate leaves by copperplate or lithographic process for insertion in the book never receive printed paging, although they may be reckoned as pages in the table of contents or the index.

APPENDIX AND INDEX

The appendix of letters, extracts, documents, or tables that are too long for the text is usually in type one or two sizes smaller than that of the text. It may be set close and solid when compactness is desired, but its subheadings should not be too compact. They should have around them enough of white space to invite the reader's attention.

The index breaks the rule of strict uniformity of treatment, for it is set solid in small type, even when every other part is leaded. Two columns of 6-point type are common for the duodecimo, and three or more of 8-point for a large octavo or quarto. As its merit is largely in compactness, some abbreviations that are improper in the text are permissible in the index, but the full names of persons should be spelled out, wherever it is possible, to prevent a misleading direction.

The hanging indention of one en is enough for an index in two or three columns. There need be no rule between the columns. In the copious index, the first word of every reference, or the two or three words that follow, may be set in the slightly bolder type of a light-faced antique, but the body of the reference should be in plain roman lower-case. The old method of making a separate line for each subdivision of that reference, and of connecting it by leaders to figures at the end of the line, is obsolete.

References in an index to different volumes are often put in roman numerals of capitals, but they are large, wasteful of space, and not the clearest guides to the searcher. For this purpose arabic figures of title type or light-faced antique should be preferred. The period at the end of each subdivision of the general reference is not needed; the semicolon is a better mark of separation. Commas before page figures should not be omitted. Cross-references and note-references should be in italic.

POETRY

A three-to-em space is wide enough for the proper separation of words of poetry in solid or single-leaded composition. The en quadrat may be used for double- or treble-leaded matter, but it is not an improvement, and spaces of greater width are a positive blemish. To avoid the turning over of a long line, very thin spaces have to be used occasionally, even when they mar the general uniformity of spacing in the page, for the turned-over line of one syllable, often unavoidable, is a greater misfortune than too thin spacing. When it is practicable, the word or syllable turned over may be put at the end of the preceding line or following line after a bracket. This may be done when the matter has to be kept on one page or in a specified number of pages, but it is not to be advised for open composition in a generously planned book.

The word turned in a separate line should be so deeply indented that it cannot be mistaken by the negligent reader for a new line. A modern practice permits this turned-over line to be set flush with its preceding line, but it does not meet with general approval. Lines from which words are turned over should never be spaced out to full measure.

The variable indention of different lines is usually determined by the author. When his intent is not clearly expressed, give a similar indention to the lines that rime. Sonnets are sometimes indented artificially in the copy without regard to their rime. Odes are another form of verse not to be controlled by arbitrary rules, and they must be set with the irregular indention directed by the author.

Indention should be so graduated that there will seem to be an equal amount of blank on each side of the page. In making up pages of short poems in different metres, the indention may have to be changed for each poem, so that the entire body of verse on that page, and not one or two stanzas only, shall be fairly centred. The different measures on different pages of the same book of poems cannot be indented by any inflexible rule.

The running title is the one line that can never be changed with safety. Never move it or the paging figure at the end of the line either to the right or the left to make the body of an irregularly indented mass of poetry seem in the centre of the page. The paging figures are often the only safe

guide the pressman has in making register when he prints the sheet on the reverse side. If paging figures are put out of place it is probable that the pages will be badly registered, and that the incautious folder of the printed sheet will so fold it as to make uneven margins.

Single quotations are a new fashion for poetry, but they are feeble; they make unsightly gaps of white, and should be used only in strict reprints or when especially ordered. It is the more acceptable practice in poetry, as in prose, to make use of the single quotation-mark for the quote within a quote.

“Curse on him!” quoth false Sextus;
 “Will not the villain drown?
 But for this stay, ere close of day
 We should have sacked the town.”
 “Heaven help him,” quoth Lars Porsena,
 “And bring him safe to shore;
 For such a gallant feat of arms
 Was never seen before.”

In all stanzas put the quotation-marks in the space made by indention, so that the first letters of each verse shall line vertically as they would line if the quotes were not used. Do not allow the quotation-marks to make irregular the vertical lining of capitals. The quote-marks are not integral parts of the sentence, and when they are treated as if they were, the intent of riming indention is obscured. The neat making up of pages of poetry is always

difficult when the stanzas are unequal. Division of a stanza between its rimed lines, or after its first line, or before the last line, are faults to be avoided by overrunning and by increasing or decreasing the blanks in previous pages. These are troublesome expedients, but they cannot be evaded. Fixed rules for preventing these irregularities are entirely impracticable. The compositor should study the make-up of poems in good editions of standard authors. An examination of the authorized edition of a hymn-book will give useful suggestions.

INITIAL LETTERS

Large initial letters at the beginning of chapters or important divisions of a book are old and useful devices for adding to the attractiveness of print. They should be used oftener. For the ordinary book the plain two-line initial of standard width is in most favor. Its form should be that of the type of the text, but perfect harmony is not always attainable, and the compositor often has to be content with one that is not an exact mate. An initial letter that spans two lines of solid composition is to be had of type-founders, but it may be difficult to find one that will close the greater vacancy made by leaded lines. Yet it is important that it should fairly fill this vacancy. To be a real improvement to the page, the top of a two-line initial should line with the top of the types in its following first line

of text, and the foot of that initial should also exactly line with the foot of the second line of text. An initial that does not neatly fill the gap made by lines of type is not a merit but a blemish.

THIS INITIAL is on **W**HEN NOT ON LINE an
line at top and foot, unsightly gap is left
and fairly fills the vacant space, at the top and above the
third line.

This gap over the third line of text is often caused by unwisely selecting the broad-shouldered capital of a very large type. This fault can be prevented by cutting off this shoulder when it has to be used as a two-line initial.

When the text type is small, a plain initial that spans three lines of text may be selected to advantage, but this selection is made troublesome by the steadily increasing width of large types, and especially of types like A, L, Y, etc., with strokes that do not fill the body, and that do make ungainly patches of white. To lessen this blemish in type a moderately condensed letter may be selected, but an extra-condensed initial is never a betterment.

The types that immediately follow a large initial may be small capitals or full capitals. Small capitals should be preferred when they make perfect lining. Full capitals of a large text-type after a large initial are not always pleasing, for they suggest newspaper advertisement display, and in a narrow measure may compel hair-spacing.

If the first word or first line following an initial is ordered in italic, the rule of exact mating may require the special engraving of an italic initial. A roman initial before italic letters is not pleasing.

THE high initial, that lines at the foot and projects upward as here represented, was frequently used in poetry and open composition by printers of the eighteenth century. It is not suitable for compact composition, but it can be selected with advantage for some forms of open catalogue matter, or for paragraphs divided by lines of quadrats.



MEDIEVAL initial letters of uncial form, that have curved strokes and claw-like terminations, were common in early books with texts in roman character. Black-letter initials were not always used with black-letter texts, for the curved lines of uncial capitals seemed better adapted for the decorative work about the initial. They are preferred now in the reprints of old books, and are frequently used in England and Germany, in their smaller sizes, as occasional capitals for the text of devotional and ecclesiastical books.

ECCLESIASTICA LETTER

MONASTICA TYPE

For ordinary books the engraved initial should be on a square or right-angled body. When it has

straggling lines of decoration that project in the margin or toward the chapter head, this irregularity is never rated as a fault, but

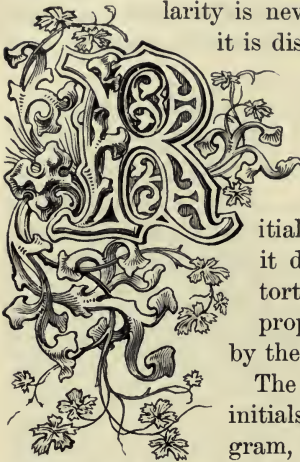

it is distinctly displeasing when

these lines project at the right or at the foot, and give ragged endings to lines of type.

The beauty of the initial is in its fittingness, but it does not fit when it distorts the lines out of their proper places, as is shown by the side of this initial R.

ing the letter, and When the initial is of the text can be the initial will seem to

The last novelty in designed initials is an upright parallelogram, the upper part containing the letter, and the lower part the decoration. When the initial is so drawn, the lines of the typeset can be kept trim and square, and the initial will seem to be a proper mate for the type.



HE pierced initial, with a hollow centre in which any letter can be placed, is a good substitute for the plain two-line letter, but at head and foot it should have true alignment with its corresponding lines of the text.

It is an acceptable form for general service, but repetition makes it unpleasingly monotonous.



THE fac initial, the typographic substitute for the eighteenth-century pierced initial, may be used now with propriety in imitated reprints of the books of that period, but it is whimsically out of date in any modern book. A pierced initial made up of small flowers of recent design is no better than the old fac, for it always has a mechanical appearance, even when it has been most skilfully composed.



AN initial letter inserted in a hollow square made from four corner flowers that fill a full circle may be quite as objectionable as the pierced initial. The connected lines easily made by the expert designer are rarely produced by the combination of movable types.



THE PROFUSELY ORNAMENTED INITIAL of black-letter with interlacings of flowers or vines, or with long, straggling streamers of tracery, once in high favor, is now deservedly neglected. It had, and may have now, some fitness for the open composition of poetry or in a very open piece of display where its streamers may stray into a blank margin, but it is entirely unfit for any kind of square-set composition. To the critical reader its riotous decoration is a discord by the side of the trim formality of symmetrical lines of type.



TYPE-FOUNDERS' specimen-books have engraved initials of merit, but in selecting a series for general use the closeness or openness of the engraving in that series must be considered. The initial should be adapted to the type with which it will be printed. A text in 6- or 8-point type may be graced by an initial of good design that shows fine and close engraving, but it may be disappointing if the letter has not been made to be printed in red ink.



TEXT in 12- 14- or 18-point needs an initial of bold and firm lines, with broad spaces between the lines. The engraving of the selected initial should mate with the type of the text in its color and general effect; it may be dense and gray when used with small type, but it should be black and solid when it is an initial for large type.



OLD-FACED initials with a black background and white letter may be used with advantage for small or large type, but an initial surrounded with dense and delicate lines that obscure the clearness of the letter is not at all pleasing by the side of large type.



ONE LARGE INITIAL with open decoration can be selected with good effect for a text in 10-point or of larger body, but it will be made more effective if the white within the letter is made red by the use of a specially engraved O to cover the naked white. Some of its merit will disappear if this decorative letter is much reduced in size and used with large type.



ONE LARGE DECORATED INITIAL is enough for the gracing of a page. Two or more small initials may appear with propriety on the same page (as must be done in the Bible, hymn-books, and ecclesiastic manuals), nor is there any valid objection to small initials in a text under a large initial, but the selection of two or more large decorated initials of the same size and style for any open composition, as in a title-page, is a mistake. They nullify one another.



LARGE ORNAMENTAL INITIAL can seldom be used with good effect within a broad floreated border. This method of treating a title-page that seems bleak may present itself to the compositor as a good filler of vacant space, but it will rarely prove satisfactory. The designer may do so with propriety when he connects it to the border or gives it a similar ornamentation, but the compositor who has to make

selection from a type-founder's specimen-book will seldom find an initial that suits the border. When it does not suit, the initial should be omitted. Ornament is the wine and spice of typography, and must be used with discretion. Good arrangements of composition are often spoiled by the too lavish sprinkling of initial letters and ornamentation of like nature that make the text insignificant.



THE fault of many initials is in what artists call their niggling, in overworking them with too many dense lines that put them in unpleasant contrast to the clearness and openness of text type. The size of the initial should be selected with reference to the size of the page: for 24mo and 18mo it may be small; for 8vo or 4to it must be large. Initials that are petty always give a petty appearance to the page. Plantin had for his books in folio some that were nearly three inches square. A small initial may be selected with pleasing effect for lines under subheadings, but the initial for the opening of a chapter or for any important division should be large and rememberable. If the initial letter has been cut to show white, the decorative lines about it should give the color effect of pale gray or of full black. If the gray so produced is too pale, the white letter can be made red by special engraving. Distinctiveness of the letter always should be considered when black ink only can be used.



FOR general adaptability the odd initials designed by William Morris for his Kelmscott books, and reproduced by the American type-founders, will be found satisfactory, even if they do seem coarse as well as quaint. They deserve study for their intelligent contrasts of black, gray, and white color. A black letter is usually ringed with a thin band of white, and its rude lines of decoration are



made by white lines on black, that produce the gray effect. The white initial letter in outline only is surrounded by decorative lines, that give the effect of dark-gray color. The letter always has proper prominence, and the decoration is kept subservient.

In the specimen-books of type-founders are a few forms of small ornamented capital letters that may be used to advantage as small initials, but those that are too profusely ornamented or grotesquely obscure should be avoided.

HEAD-BANDS AND TAIL-PIECES

After useless attempts at the reproduction in two or more colors of the elaborate decoration of the fifteenth-century illuminators, the early printers of books confined their attempts at decoration to designs that could be printed in black only. The

160 *Thin head-bands between chapters*

broad border and a centre-band between columns had to be abandoned, for they wasted paper and helped to make the book of high price. Some new form had to be devised, for the method of beginning a chapter at the head of a fresh page was then almost unknown and seldom practised. Obeying the old practice, each printed chapter closely followed its predecessor, and the two meeting chapters were separated by a big initial or a line of large type as the first line of the new chapter. This did not seem to be enough. Then came a simpler fashion of a plain or decorated band between the chapters as the proper mark of separation.

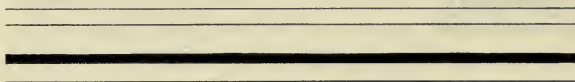

When pages were small and the chapters were not too short, each chapter was placed at the head of a new page under a broad blank. This treatment left the head of the page disagreeably bleak. To fill up the blank space, a head-band of brass rule or of type border was inserted. Sometimes the head-band was designed by an expert who mated it in style with the following initial letter. It also became necessary to fill the vacant space left at

the end of the chapter, which might be one half or two thirds blank. For this purpose the tail-piece was devised. Conforming to the old fashion of setting the last paragraph of a chapter in funnel shape, the tail-piece was made in the form of a triangle, with its broad side nearest the type-work.



This method of decorating the book, introduced in the sixteenth century, has never gone out of fashion, although it is seldom used now for books of serious subject-matter. When properly selected, the head-band and its mated initial letter and tail-piece are welcomed reliefs to the dulness of text type. They clearly mark important divisions and fill space that might be unpleasingly vacant.



There is no rule that arbitrarily prescribes the shapes, sizes, or styles of these decorations. The head-band may be a pictorial illustration that fills

one third or sometimes one half of the page, but when it is very large the type-work below must be correspondingly reduced in size. The form now in fashion is an oblong strip of decorative lines that varies in height from a quarter of an inch to two inches, but there is a general agreement among designers that it must be the exact width of the page of type. When narrower or broader, it does not



seem an integral part of the book ; it does seem a bit of added and superfluous patchwork. It usually has square endings, but the ends may be rounded with propriety ; or it may have a rounded projection at the top in the centre, for the presentation of a portrait, sketch, or medallion. It should



be flat or nearly so at the base, and should not be connected with the initial letter, nor should it have projecting lines that droop to interfere with the type below and make insignificant the type-work

of the chapter heading. Straggling vines or lines of tracery may project from an initial letter into the margin, but not from the head-band.

The sumptuous book always has its head-bands, initials, and tail-pieces designed by the same artist, so that all shall show a general similarity of treatment and be in agreement with the subject-matter. Properly treated, they are a grace, but when head-bands have been selected from those that have been made at different times by designers of unequal merit, of different sizes and in various styles of engraving, they are positive blemishes. The beauty of the proposed book depends upon harmony in decoration as much as on uniformity in type.¹

Grayness or blackness and density or openness of decoration are features to be pondered. Head-bands and initials to be used with the types of 12-point or larger bodies should show some correspondence in color with the types, in the closeness and fineness or in the openness and firmness of their engraved lines. A text type in bold-face

¹ The printer who is asked to provide a series of decorations for a proposed book should have its designs made by an artist who is qualified as a decorator, for decoration is an art by itself and cannot be done properly by any one, however high his merit as an artist, who has not studied decoration as an independent art. Decoration drawn with pen and black ink on paper can be repro-

duced at small cost by the photo-engraving process. If the printer intends to make use of these designs for that book only, he can have emblematic devices appropriate to the book incorporated in the decoration; but if he proposes to use them afterward for other books, he must exclude all emblems of special significance and instruct the artist to make the designs generally applicable.

164 *Head-bands should mate with types*

may have decoration in nearly solid black, with touches of white-line ornamentation only; but if the text is to be in 6- or 8-point type of roman face, a closer style of engraving that matches the general effect of gray color in the type will be more pleasing.



Sharp or dense lines in a head-band over types that are relatively coarse or open seem badly selected. When lines too coarse are put by the side of delicate types, the effect produced is also unpleasing.¹

For a book of many chapters the engraved head-bands of type-founders are seldom suitable, for they may be found too short or too long for the intended measure, too dense or too coarse, or improper mates for the initial letters that may have been previously chosen. They are more serviceable as marks of division in pamphlets that do not require a large number of similar size and design.

¹ It is customary for artists to make designs for decoration on a large scale, but their largeness may be deceptive. What is clear and entirely satisfactory in the drawing may be petty, foggy, and disappointing when it has been reduced by the photo-engraver to the size that is needed for printing. This disappoint-

ment may be foreseen and prevented by examining the design under a reducing-glass. The sketch on a small scale may be enlarged with some loss of delicacy, but with no loss of value, but the sketch on a large scale with dense lines will be monotonously gray when reduced, and may make an unprintable plate.

Head-bands made from combinations of flowers or small borders are vain substitutes for special engraving. Their ineffectiveness as decoration is apparent in the faces made by French and English printers of the eighteenth century. Made-up head-bands are rejected by all discreet publishers, but there are compositors who still take delight in making them from little bits of border. The time spent in their composition is not justified by the result, for the head-band so produced is always labored, mechanical, and unsatisfactory. A clever designer can produce in an hour a pen sketch of more pleasing decoration than can be made up by a compositor from bits of border in a day.

Parallel rules, or sometimes thick double rules, have been selected as appropriate head-bands for the chapter heading of a new page, but a feeble rule is petty in that prominent position, nor is it pleasing when it divides two short chapters on the same page. The blank made by lines of quadrats is more generally acceptable. Thin strips of border on 6- to 18-point body can be used with better effect, but the border selected should fill or nearly fill the body, and should have no corner flower. For poetry and very open composition a border of light and open lines should be selected; for solid or single-leaded composition a border of strong contrasts of black and white should be preferred. Carefully avoid the selection of the overworked typographic borders of the eighteenth century, for the reading

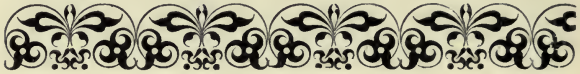

Head-bands of type borders.

world has had enough of the feeble gray effects visible in these old-time typographic decorations. The borders now provided by type-founders are not yet hackneyed ; they have more grace, and show a proper contrast of light and shade. Borders in the so-called Elzevir style, or in the Byzantine or Turkish style, of strong black and white, entirely free from dense lines and overworked gray shading, will be found useful material for typographic head-bands for books that do not warrant the expense of special engraving. The larger pieces are most satisfactory. They are not improved, but are really damaged, when surrounded on all sides, as is often done, with a narrower and lace-like border.

The typography of a book should show a visible agreement with its subject-matter. If addressed to the thinking and reasoning faculties of a mature reader, as is the case in treatises on law, theology, or science, it needs no bold type and no decoration ; but if it has been prepared for the study of young students, the severity of a too plain style may be modified. Its subheadings of prominence or its rules or propositions may be set in a bolder type, and two-line initials or other trivial changes that will make the text more comprehensible may be added. Yet it does not need decoration. Bold display, eccentric lettering, and fanciful arrangements are attractive in certain kinds of job-work, but they are out of order in any book intended for

a permanent place on the library shelf. It is the thought of the author, and not any grace of the decorator, that is most prized by the reader who is also a student. It follows that the type-work of a book should be kept in strict subordination to the main intent of the author.

In the ordinary book, avoid decoration and odd types that do not make the subject-matter clearer. The great masterpieces of printing are the simplest. Plain types correctly composed and neatly spaced, with strict attention to petty details, clearly printed in strong black ink on unobtrusive paper with appropriate margins, have a charm that is recognized by an inexpert. He may not know why they are more restful and attractive than the profusely decorated book, but he will see that the book so treated does show marked superiority in its workmanship.

Yet books with decoration are needed. Those that are classified under the name of light reading, not intended for study, but for amusement or information, may receive ornament in many forms, from occasional lines in red ink or border lines of brass rule to elaborately engraved head-bands, initials, and tail-pieces, broad borderings of flowers or rules, explanatory illustrations, inks of many colors, or a text letter of some eccentric or peculiar design. These are some of many methods of making a book attractive, but most of them call for an amount of skill, patience, and expense that seems out of proper proportion to the result attained.

An amateur soon finds that profuse ornamentation which must be treated in painstaking manner by every contributor from the designer to the book-binder is too expensive, and quite prohibitory. It often has to be abandoned. Yet he hopes to get the desired result by the selection of eccentric type for the text, which seems to be the cheapest of all his attempts at improvement. On the contrary, it may be the most hazardous.¹

In the narrow compass prescribed for this work it is impossible to describe with clearness the typographic details that will be appropriate for every variety of book. It should be enough to offer this suggestion: before undertaking the composition of

¹ Ornamentation is not to be undervalued, but he who undertakes it should be sure that it is ornament and not pure meddlesomeness. A page of print, like an engraving or a picture, can be spoiled by fussy additions that divert the attention from the main subject. The common fault of the amateur is the filling up of blank space with needless decoration. The running title of the book, when not spaced out to the extreme width of the measure, is filled with bits of border that make it and its paging figure insignificant, or it is fenced off from the text below with rules that annoy and do not help the reader, for the rule is more prominent than the type of the text. The last line in every paragraph may be filled

with bits of incongruous borders. Even the title-page of the book may be filled with flourishes, or divided into panels with borders of brass rule. Ornament of this description, often made still more conspicuous with many colors, is sometimes demanded by the publishers of advertising pamphlets and ephemeral books, in the belief that this treatment will make the book attractive and help speedy sale. When the decorations of type-founders fail to meet the need, recourse is often had to the pen drawings of amateur designers, and it is largely from examples set by men who do not see the full scope of the work and do not appreciate the need of general uniformity that the compositor receives bad lessons in decoration.

any new book of merit, the typography of good editions of similar nature should be studied, and their good features should be imitated wherever imitation promises to be of service. The designing of entirely new styles should be discouraged. It may be assumed by the novice that it will be safer to copy the best features of books of high merit than to attempt the invention of new forms.

Over-decoration is a common fault. In no case should much ornament be added, unless especially ordered and unless it is certain that the type, paper, and presswork of the book to be made will be of the best. Even when ornament is ordered, there should be a leaning toward simplicity. Appropriateness should be considered. Eccentricities that are pleasing in one book may be positively tawdry in another. The young compositor is especially warned against the hackneyed decorations of the printers of the seventeenth and eighteenth centuries. They may be used occasionally with advantage when the old designs have been redrawn and recut; they will seldom prove of real value if not mated with text types of their own period.





GEORGE BRUCE

V

DIFFICULT COMPOSITION

Algebra . . Tables and table-work . . Music . . Genealogies

ALGEBRA



WHEN composed from types cast upon irregular and unmatable bodies, algebra is emphatically a difficult form of composition, for it requires much time-wasting justification with thin leads or pieces of thick paper. It can be composed with more facility if the needed types and rules have been made on the point system, but under the most favorable conditions algebra will be troublesome. It has rules of its own for spacing and division that must be observed, and the compositor needs some skill in the art of

combining in a workmanlike manner, yet by new methods, the rules, fractions, and abbreviations of different bodies. A text in 10-point may require characters varying in height from 5- to 72-point.

The following table exhibits the algebraic signs provided by type-founders as a full assortment for ordinary work, but some of the characters are needed only in books of higher mathematics :

+ plus	≈ nearly equal	△ triangle
- minus	to	∫ integration
× multiplied by	∞ difference	∫ integration
÷ divided by	≈ difference be-	∫ of a quaternion
= equal to	tween	
: ratio	∝ variation	≠ minus or plus
:: proportion	√ square root	∴ hence, there-
≠ plus or minus	∛ cube root	fore
< less than	° degree	∴ because
> greater than	' minute	∞ infinity
⩾ not less than	" second	⊥ right angle
⩿ not greater	○ circle	⊥ perpendicular to
than	□ square	
≈ equivalent to	◻ rectangle	≡ identical with
≠ not equal to	∠ angle	≐ approaches

Before he begins composition, the novice should learn the names and uses of the signs, and should closely study their arrangement in some approved treatise. Alphabetical letters and the figures that usually accompany them need no explanation, for

they are provided in every complete font of roman and italic type. For use as exponents or indices, thus x^n , $x^{(n)}$, x_n , italic lower-case letters are preferred.¹

+ - × ÷ = :: # * < > < > ∞ ≠ ≈ ≅ ≡ √ ° ' " ◊ ◻ ◻ ◻ ∠ △

Characters on 5-point body.

The signs on the previous page are on 10-point body, but signs are also made on 5- 6- 8- and 12-point bodies. Two bodies are often used together. The radical sign $\sqrt{\quad}$ is required on many bodies from 5- to 72-point, and the figure that defines its power should be nested in its angle.

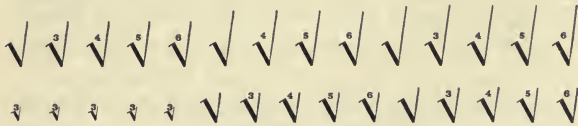

Different sizes of parenthesis and bracket, varying from 12- to 44-point, will be needed to inclose the different divisions of a compounded formula.

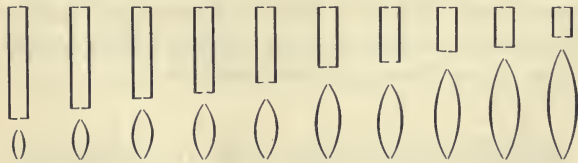

¹ In some formulas there may be an occasional capital, or a letter of the Greek alphabet, or inferior letters in roman, but they are rare. When roman letters are used for superiors, the inferiors always appear in italic, or vice versa. The tendency now is to the selection of but few alphabetical letters.

Braces of light but firm face, in sections as well as in one piece, are made of different lengths from 10- to 72-point. Like the parenthesis and bracket, they are of different lengths, but on 6-point body.

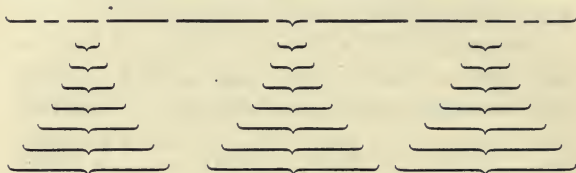

Piece-fractions are often required, and special care should be taken to get those that are very distinct.

$$\frac{1}{4} \frac{1}{2} \frac{3}{4} \frac{1}{3} \frac{2}{3} \frac{1}{8} \frac{3}{8} \frac{5}{8} \frac{7}{8} \qquad \frac{1}{4} \frac{1}{2} \frac{3}{4} \frac{1}{3} \frac{2}{3} \frac{1}{8} \frac{3}{8} \frac{5}{8} \frac{7}{8}$$

A much-used notation for the fraction nowadays is the "solidus," as $2/3$, where 2 and 3 are printed in the same font as if integers.

Superior letters (usually in italic) and figures must be provided for each one of the two bodies that have been selected. Inferior letters and figures are not so common, but the assortment is not complete if they have not been provided.

a b c d e a b c d e 1 2 3 4 5 1 2 3 4 5

Superior and inferior letters and figures on 10-point body.

The brass rule to be preferred for the dividing line is on 2-point body, for it will give the least trouble in justification. Labor-saving rule of this

body cut to even ems and ens of the text type, and in abundant supply, will be a valuable aid to neat composition.¹

Algebraic expressions that show the two lines of numerator and denominator, or of dividend and divisor, separated by the usual dividing line, may need root signs, braces, brackets, and parentheses twice and sometimes thrice the height of the text letter. If the text type is on 10-point body, the radical sign will be of 20-point body when small figures are used below the vinculum, as in the upper example. If figures of a larger body are ordered under the vinculum, then a radical sign of 25-point is needed for neat presentation of figures.

$$\sqrt{\frac{78.43}{90.76}}$$
$$\sqrt{\frac{724+60}{127-96}}$$

The characters needed for a treatise on algebra comprise sorts on many bodies that cannot wisely be stowed in one case, for which reason the diagram of an algebraic case is omitted. The laying of sorts for the composition of algebra is governed by personal choice. The quarter-section case that can be placed by the side of the italic cases most needed will be found of good service. The order of laying should be exactly the same for every size,

¹ It is not good policy to allow the compositor to cut rules as he needs them. Rules so treated are liable to be irregular as to length, with burs on cut edges or slight bends in the body, and these defects tend to insecure

justification, and give needless trouble to maker-up, stoneman, and electrotyper. With proper forethought, algebraic composition can be made as solid and secure as that of ordinary roman type.

and a clearly written label should be pasted on each box to prevent wrong distribution.

The composition of algebra differs from that of the ordinary text in its spacing, purposely made uneven. The italic letters that serve as symbols for quantities must always be set close together. Superior or inferior letters, figures, and fractions are controlled by the same rule. But the signs $+ - \times \div = > <$ must be treated as distinct words, and be separated from the context by spaces of noticeable width :

$$\begin{aligned} 2 \textit{abx} - x^2 &= 14 \textit{ab} - 7 x \\ 6 x^2 + 3 \textit{ax} &= 2 \textit{bx} + \textit{ab} \end{aligned}$$

Superior figures are always set close up to their proximate letters, but the larger figures of the text type should be separated from following italic letters by a four- or five-to-em space. The space may be omitted only in a very crowded line :

$$x^5 + 4 x^4 + 2 x^3 + 9 x^2 - 4 x + 4$$

In algebraic formulas that have mutual relation or dependency, the figures of whole numbers must be kept in strict vertical line according to the rules of

$$\begin{aligned} 8 x + 9 y + 8 z - 2700 \\ 12 x + 12 y + 10 z - 3600 \\ a x + b y + c z - d \\ a' x + b' y + c' z - d' \\ a'' x + b'' y + c'' z - d'' \end{aligned}$$

arithmetical notation. In formulas that have many consecutive lines with few or no figures, the signs + and -, which separate distinct terms, must be kept in vertical line. This rule for vertical lining sometimes applies also to the sign \times for multiplication and to \div for division.

It often happens that a long formula cannot be put in one line of the type selected for other formulas. When great compactness is desired, as is important in some school-books, it is customary to set this long line in types of a smaller body that will take in one line all the characters. When it can be done, it is better practice to put the matter in two lines in large type, but the composition cannot be divided arbitrarily. The place selected for division should be at one of the signs +, -, or =, for they represent transition points at the end of distinct terms. The part turned over in a second line must be placed in the centre of the measure:

$$ax^2 - bx = cx - d$$

Expressions that would divide badly are frequently put intact in the middle of a following line.

Connective words like as, in, again, that precede the expression in that line, are placed at its begin-

or again

$$y - x = 4$$

ning, and a broad white blank follows, to show that the connective word is not a part of the formula.

Figures inclosed in parentheses or brackets that are inserted to refer to other formulas or terms in the same book must also be separated from the formula in that line by the same method. They may be at the beginning or end of the line. If a mark of punctuation is needed, it must be put after the bracket or parenthesis :

$$\text{or} \qquad ax + by + cz = d \qquad [1];$$

Whole numbers expressed in many figures are not separated by the comma in triplets, as is usual in arithmetical notation, but in a decimal number the integral part should be separated from the fractional part by the decimal point. These fractions and the decimal point that precedes them must be kept in a vertical line in all the rows of figures, without regard to the irregular lining at the beginning or ending of the lines :

$$\begin{array}{r} 927.67892254 \\ 3643851.5468 \\ 22982.657462 \end{array}$$

When many characters must be put in one line, the spaces between terms and signs may be relatively thinner. The space before or after a sign like + or - may be omitted when this sign is next to a superior or inferior character, but it is better practice to use the space in all places where it will add to the clearness of the expression.

A visibly wider space must be presented between distinct expressions shown in the same line :

$$54 a^2b^3(a^2 - 2 ab + b^2) \quad , \quad 36 a^3b^2(a + b) \quad .$$

No space should be put between alphabetical letters and superior figures that are grouped in one term and inclosed in parentheses or brackets :

$$28 a^6b^5cd^3x^3 \quad 6 ab(a + b) \quad (6 a^2bc^3x^5)^3 = 216 a^6b^3c^9x^{15}$$

When an author wishes that an expression in the text should have noticeable distinction, he orders or marks more space before and after that expression, as it here appears :

The quotient of $18 a^4bx^2$ by $6 a^2bx$ is $3 a^2x$.

As a term cannot be divided with part of its characters at the end of one line and the other part at the beginning of the next line, some irregularity of spacing has to be tolerated.

Thus the quotient of $15 a^2b^3x$ by $3 a^2b$ is written $5 a^0b$; but we have seen that the quotient should be $5 bx$, as the factor a^0 does not alter the product, since a^0 is equal to 1.

The points of punctuation that separate clauses in the text have a broad space before them in any clause that ends with an algebraic term.

When a long algebraic expression cannot be put neatly in a single line, it may be divided, but the characters in a term inclosed within brackets or parentheses must not be divided at all. It may be again repeated that the proper place for division is at the signs of operation + or —, occasionally \times or \div :

$$(am + a'n - a'')x + (bm + b'n - b'')y + \\ (cm + c'n - c'')z = dm + d'n + d''$$

To prevent the improper division of characters in the middle of a term, the first line may be made shorter than the second :

$$0 = -2 (p''p'N'') \\ - \frac{1}{\Delta'} \left[n^2(1 - v'') + N'' + n'(n'n'' - N'') \frac{\pi''}{p''} \right]$$

In the following example the entire expression within the vertical braces is to be multiplied by the fraction at its left. The arrangement of the terms within the braces is suggested partly by the length of one of these terms, the second, and partly by considerations of symmetry. Observe that the fraction at the left is so placed that its dividing line meets the central point of the brace.

$$\frac{q'}{(n' - 1)p'p''} \left\{ \begin{array}{l} 2 n'(p'' + p'N'') \\ + \frac{n'}{\Delta'} \left[n^2(1 - v'') + N'' + n'(n'n'' - N'') \frac{\pi''}{p''} \right] \\ - p'[n'^2(1 - v'') - (n' - 1)N''] - (2n' - 1)p'' \\ + \frac{(n' - 1)}{p'p''} N'' \end{array} \right\}$$

The rule that separates the numerator from the denominator, or a dividend from a divisor, must be exactly of the length of the longer term, as is customary in arithmetical notation, and the shorter term must be placed over or under the longer term exactly in the centre :

$$\frac{2}{15} \quad \frac{268}{10000} \quad \frac{c-by}{a} \quad \frac{B}{0.00001}$$

When one of two terms is simple and the other is double, the point of punctuation, if one is ordered, should be opposite the dividing rule of first term :

$$x = \frac{17 + 7}{2} = 12, \quad x = \sqrt{\frac{-b + \sqrt{b^2 - 4ac}}{2a}} ;$$

The preceding illustration shows the value of the point system in algebraic composition. In the first formula we have, in the middle of the term, two lines of 10-point and one dividing rule of 2-point, that make its full height 22 points. The characters $x =$ before, and $= 12$ after (each on 10-point body), are easily made to centre with the cross-rule. If this formula were the only one in the mixed line, these characters could be solidly justified in that position with an upper and a lower line of 6-point quadrats, but the second formula in the line is of greater height, for it has two lines of 10-point and three rules of 2-point, and must be 26 points in height.

To justify this second formula solidly with the first, an upper and a lower lead of 2-point must be added to the first formula. Point bodies simplify justification. If types and rules are not on the point system, the exact justification of two formulas in one measure will be much more troublesome.

The solid manner in which algebraic formulas can be constructed is plainly represented in the following diagram, copied with slight alteration from the *Katechismus der Buchdruckerkunst* :

$$\begin{aligned} \text{tang } \frac{\beta}{2} &= \sqrt[3]{\sin^2 \left(\frac{34^\circ 27'}{2} \right) + \cos^2 \left(\frac{34^\circ 0' 3''}{4} \right)} \text{ or} \\ &= \frac{1}{2} \int f(x) dx + \text{Const.} - \frac{1}{2} f(z) \text{ etc.} \end{aligned}$$

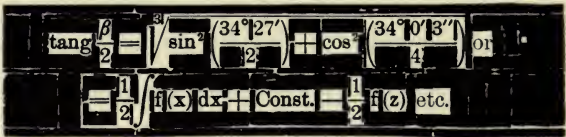

When a short but complex formula is incorporated in the middle of a line of plain descriptive matter, it is customary to begin the work by setting up this formula first, which is then temporarily put aside in another stick.¹ Then the descriptive text that begins the line is set in the first stick. If the text is of 10-point, and the formula is 22 points high, this difference of 12 points must be made up

¹ A second stick with knee adjustable by a clasp (Grover pattern) will be helpful in the composition of complex formulas.

by setting a line of 6-point quadrats under the text matter, and adding over that matter another line of 6-point, or two lines of 7-point can be used. This treatment will bring the text matter on the central line of the formula, where it should be. Then the formula temporarily put aside in another stick can be added, and the remainder of the text for that line can be composed in like manner. To produce solid justification, leads and cards must be avoided wherever it can be done safely.

The incorporation of a short complex algebraic expression within a line of descriptive text in plain roman type unavoidably produces wide blanks between the lines of that text. Some authors prefer to have short expressions in the centre of a separate line, but this method cannot be resorted to when they appear too frequently in the copy.

The two expressions $\frac{2N}{N+n^2}$ and $\frac{N+n^2}{2n^2}$ are equal when N is equal to n^2 ; and when N is nearly equal to n^2 , the expressions $\frac{2N}{N+n^2}$ and $\frac{N+n^2}{2n^2}$ are nearly equal; therefore their arithmetical mean is nearly equal to their geometrical mean.

The vinculum that projects from the root sign must be of the exact length of the expression it is intended to cover:

$$\sqrt{a}$$

$$\sqrt{162 a^7 b x^4}$$

In an expression which involves two radical or root signs, where the vinculum of one root overlaps that of the other root, as will be seen in the illustration that follows, the superior vinculum must show a visible separation from the lower one :

$$+\sqrt{-\frac{p}{2}-\sqrt{\frac{p^2}{4}+q}}$$

Index figures are often needed as exponents. When the signs provided are solid and not slotted, the compositor must have them properly nicked for the insertion of the figure. This nicking can be done with knife or chisel, if the compositor is handy with tools, but it will be made in a more workmanlike manner with proper tools by the electrotyper. In either case the nicking causes annoying delay.

Exponents, whether integral or fractional, should be in italic, and be placed as superiors on the upper line of the symbols that they define.

$$a^{mq} \quad a^{\frac{3}{2}} \quad a^{\frac{mp}{nq}} \quad \left(e^{(a-x)^{\frac{1}{2}}} - 1 \right)$$

Inferior letters, or subscripts as they are sometimes called, are less frequently used, but they should be in italic, and be placed below the line of the letters to which they are attached.

$$S_{m-1}l \quad C_{m,n} \times P_n = A_{m,n}$$

Formulas may be written in which the same letter will take an exponent and a subscript, as it does in $X_1^{(n-1)} = 0$. There are a few that require two subscripts, as in $\text{tang } {}_0X_m = Pz_1$.

Integral signs may take a letter at the foot and at the top. Sometimes these letters have exponents or subscripts arranged thus :

$$\int_0^l (T-R) \quad \int_{x_0}^x V dx$$

The abbreviations sin, log, cos, tang (for sine, logarithm, cosine, tangent) should be in roman character in all formulas, and should not be followed by an abbreviating period. The superior figure that may follow the abbreviation of sin, cos, etc., must not be separated by a space.

$$x = p \left[\left(\frac{1 - \cos c}{\sin c} \right) - q^2 \left(\frac{1 + \cos c}{\sin c} \right) \right] + p^2$$

Parentheses, brackets, and integral signs that precede or inclose a fractional expression must be of the exact height of the expression, including dividing or vinculum rules.

$$\left(\frac{p^2}{4} - q \right) \int \left(\alpha + \frac{1}{x} \right) \left(\beta + \frac{1}{x} \right) dx \quad \left(p'p'' - (n' - 1) \frac{p''}{\Delta'} \right) q$$

This must be done if but one of the parentheses, or but one of the brackets, comes immediately after or before a fractional term. It must also be done

186 *Marking of figures for logarithms*

when one or more of the intermediate terms of the expression are fractional, the first and last terms being integral, as in

$$\left[n'n'' - N'' \left(\frac{\pi''}{p''} \right) - p'^2 N'' \right]$$

But if the brackets or parentheses inclose integral terms only (as shown below), they should be on the same body as that of the characters within them :

$$n'[n + (n'n'' - N'')p'p'']$$

When radical signs occur within parentheses, the parentheses should be of the same height as the radical sign :

$$\frac{a(p - \sqrt{q})}{p^2 - q} \frac{(\sqrt{a})^2}{(\sqrt{b})^2} = \frac{a}{b}, \quad x = \left(\sqrt{\frac{a^2}{2g}} + at - \sqrt{\frac{a^2}{2g}} \right)^2$$

When many parentheses have to be employed, one within another, they may be selected of different heights according to relative importance, but they make an awkward formula. It is better practice to use a bracket for the exterior sign of inclosure, and this bracket need be no higher than the interior parentheses.

In a logarithm the short stroke that overlaps a negative integral figure or "characteristic" must not be wider than the figure. If the characteristic have two figures, the stroke should overlap both.

$\overline{2}.3010300$

$\overline{15}.1345769$

In the expression of fractions continued in many different lines, the figures selected for the divisors should be placed exactly under the figures used as dividends, and the divisor rule should exactly overlap these figures, as is shown in the illustration.

$$\frac{1103}{887} = 1 + \frac{1}{4 + \frac{1}{9 + \frac{1}{2 + \frac{1}{1 + \frac{1}{1 + \frac{1}{4}}}}}}$$

Manuscript copy of algebra is usually prepared with care: the writer makes clear the difference between the ordinary and the superior characters, and tries to put no more letters and figures in the manuscript line than can be properly expressed in one line of type. Yet it often happens that the compositor may be perplexed by the inequality in the length of the characters above and below the dividing rule in a complex formula. Will it come or not come within the measure without wrong spacing? The old way was to set all the characters (those above as well as below the dividing rule) in one long line and put them aside upon a short galley, where the spaces could be rearranged.

It is a better way to begin and complete the composition of the fractional portion of the expression in a Grover stick, which readily allows a readjustment of the measure and of the spacing between terms or factors. If this fractional expression consists of two lines of 10-point and one 2-point rule,

the height of the formula will be 22 points, which must also be the height of the larger brackets or parentheses, if they are needed. When these signs have been reckoned, the compositor can mentally determine the spacing of the term that precedes or follows the complex part. He puts in the stick of full measure two blank lines of 6-point quadrats (one above and one below the 10-point line), and then adds to them the complex part already set in the stick.

The building up of a formula of complex expressions would be easier if the italic lower-case letters could be cast on adjusted sets with spaces that exactly make up their deficiencies. Too many letters, not fractional parts of the em, have to be justified to make solid composition.

TABLES AND TABLE-WORK

When the compositor had to cut the brass rules for a table with a tinman's shears and mitre them with a file, he had good cause to dislike table-work. These clumsy tools are seldom used now, for every modern printing-house has small machines that cut and mitre rules quickly and neatly. The machines are not always needed, for labor-saving rule of many lengths and with right and left mitres is in common use. Nor is the mitring of corners always obligatory on odd lengths, for neat angles can be

made on flat-faced rule by a simpler process, as has been shown on page 53. Thick borders are no longer in favor; shrewd critics say that the border must not be blacker than the words and figures to be inclosed. In many recent books of fair workmanship, the tables are not inclosed in a border, nor are brass rules put between the columns in any place where they do not give a greater clearness to the figures.

Improved tools and materials and the tendency toward greater simplicity lighten the labor of table-work, but they do not materially change its nature. Tables require more skill than plain type-setting, but this skill is not entirely that of hand-work. A table in manuscript can be properly set only when it has been wisely planned by previous head-work.

The method to be observed in setting up the different columns of a table of words and figures is not unlike that practised in setting the columns of a newspaper. One column must be made perfect in length, headings, and blanking out before the next can be put by its side. Each column that contains words must be separately composed in its own narrow measure. Work so done is often tedious, but when the table has been properly planned, and each column correctly justified, much of its difficulty has been removed.

Explanations of the methods now in use may begin with illustrations of the simplest forms of table-work. Words, names, or figures of the same

class are usually set in columns, for the columns classify them, and make reading easier and more rememberable. To set one after another the names of persons, or the specification of different amounts in certain years, in ordinary paragraph style, is confusing to the reader. It is a much commoner practice to arrange them in columns, thus :

Edward A. Adams	J. Pierpont Morgan
George F. Baker	Levi P. Morton
John Claffin	Alexander E. Orr
Elbert H. Gary	William Rockefeller
Abram S. Hewitt	James Stillman
Morris K. Jesup	William K. Vanderbilt

To keep these names in vertical line and in alphabetical order, make up a stick to one half the width of the broad measure, and set and justify each name separately. Empty the lines so set in order on a galley, and then make up to the broad measure. Allowance for a vertical brass rule between the columns is sometimes made, but the rule is not needed, for the white space at the ends of lines in the first column is a sufficient separation.¹

¹ Yet a separating lead between the columns may be of service. If a name is added or cancelled in the proof, the lead will lighten the labor of making the needed change. It is not practicable to set the two columns in broad measure, for the second column will be more or less out of vertical line. It is possible to set the two names of one line in one stick and in the broad measure by the aid of a removable justifying gauge, as will be hereafter explained; but if the list of names is long and must appear on more than one page, the alphabetizing of the names may be faulty, and the fault will be hard to correct. The time saved by the justifying gauge will be lost in correction.

Columns of names were once set in full capitals of the type of the text, but this treatment makes them needlessly and offensively bold. Small capitals with capital initials are preferred by many for a long list of signatures at the end of a document. For a list of names inserted in the body of a text, plain roman lower-case is now in more favor. Periods should be used after all abbreviated names, but there is no need of comma or period at the end of names arranged in columns.

Columns of figures only, on the en-quadrat body, that do not call for justification in separate measures, may be safely set in broad measure.

Population of the United States

Year	Total	Males	Females
1900.....	76,303,387.....	39,059,242.....	37,244,145
1890.....	63,069,796.....	32,315,063.....	30,754,693
1880.....	50,155,783.....	25,518,820.....	24,636,963
1870.....	38,558,371.....	19,493,565.....	19,064,806
1860.....	31,443,321.....	16,085,204.....	15,358,117
1850.....	23,191,876.....	11,837,660.....	11,354,216

For the ordinary pamphlet a table of this kind can be set in broad measure without vertical rules. For a work of great nicety it is customary to add the rules, which may be of service in filling up the wide gaps produced by a succession of leaders.

When figures are planned for many columns that must be kept in timely or numerical order, each

column should be separately composed, so that all can be made up in order when the matter in the table has to appear on more than one page.

Number of ems to the linear foot

American system

3-point...289.15	10-point.86.74	28-point.30.98
3½-point.247.84	11-point.78.86	30-point.28.91
4-point...216.86	12-point.72.28	32-point.27.10
4½-point.192.77	14-point.61.96	36-point.24.09
5-point...173.49	15-point.57.83	40-point.21.68
5½-point.157.72	16-point.54.21	42-point.20.65
6-point...144.57	18-point.48.19	44-point.19.71
7-point...123.92	20-point.43.37	48-point.18.07
8-point...108.43	22-point.39.43	60-point.14.45
9-point... 96.38	24-point.36.14	72-point.12.04

A table that specifies words, dates, and amounts in columns can be set in a broad measure, but if any column has words of irregular length, it is better practice to set the

1890... Jan. 12...\$160.50
 1891... May 1... 150.50
 1892... Feb. 3... 125.00
 1893... Jan. 20... 175.00
 1894... Feb. 3... 168.00
 1895... May 16... 160.00

columns in at least two distinct measures.¹

Tables that give a column arrangement to the name, business, and residence of many persons are properly connected with leaders, but the columns should not be separated

¹ A table that has but two or three narrow columns should not be spread out to span the full measure. It will be as readable and neater in a narrowed measure, with type set by its side, as shown above in the table of half measure.

by vertical column rules when the matter has been prepared to be read across the columns.

When it is intended that the initial letters of each column shall be in vertical line, three distinct measures can be made, each column being separately justified and afterward re-made up to the full width of the broad measure. A quicker method is often adopted, as is here explained :

Begin by cutting a gauge from a type-metal slug or a brass rule of proper thickness to the combined width of the second and third columns, as is shown in the strip A. Then cut the gauge B of the width

B

A

R. Hoe & Co. Printing Presses .504 Grand Street
Lovejoy Company . . Electrotypers . . .446 Pearl Street
Harper & Brothers .Publishers331 Pearl Street

of third column only. After setting in a stick of full measure the names in the first column, put the long slug A in the stick, and justify the name column up to slug A. Then remove that slug and set the words for the second column, which should be justified in like manner to meet the slug B. That done, remove slug B and justify to the end of the measure. This method saves time and makes unnecessary the use of three distinct measures in as many sticks and the combining afterward of the three lines in one full line, but it calls for care in justification.

Slugs as justifying gauges can be used for more than three columns, but they are not recommended when the words in any column have to be turned over and fill two lines of the column. They can be used with most advantage for undivided matter that reads across the page. The turning over of words in one column and the unavoidable insertion of parallel quadrat lines in other columns is always to be avoided, for the table so treated has a ragged appearance. A name or a business with words too long to come within the prescribed limit of a column may project a little in the following column, even if this projection does destroy the vertical lining of its initials. An occasional projection carries with it the apology for its unavoidability.¹

The first difficulty met by the apprentice in trying to compose a table from manuscript copy that has many columns separated by brass rules and with cross-headings in small type is his uncertainty about the proper width of each column. Before he begins work on any table, simple or complex, he should know whether it is or is not to be set with dividing column rules and inclosed in a border rule. Next in order should come the inquiry as to the space it may or must occupy: whether it is to be in its height a part of a full page or a full page;

¹ When the words in any line of a narrow column are too many for the measure, they may be abbreviated or set in smaller type if the author permits. Small

type that will prevent abbreviations is to be preferred. The turning over in a separate line of the excess of words should be the last resort.

whether it is to be a part of or the full width of the regular measure; whether it is to be set broad so as to read the long way of the page, or whether it can be set in two sections to extend over two facing pages. All these conditions must be known before he can determine, even approximately, the size of the type that must be used.

The first process is to count the number of columns and to determine the width of each column. When the columns are of figures only, width can be quickly ascertained, for figures on en-quadrat body favor precise reckoning; but if two or more columns show words, the calculation will be more troublesome. Select the column that is apparently of greatest width, and let the longer lines in that column determine its width, for this width must control that of other columns. It often happens that the words in the different lines of this column are of variable length—some very short, some very long—and it may be necessary to narrow the measure by abbreviating words or by the use of smaller type, as has been advised for tables of simpler form. Yet there are long lines that cannot be so treated; they must be turned over to occupy two or more separate lines. This will compel the lengthening not only of that column but of the entire table, and the insertion of lines of quadrats in the parallel lines of its side columns.

Much discretion will be required in narrowing a column. It should not be pinched to make obscure

the words put in that column or in other columns. Legibility is the great merit of a table. It should be as readily readable as the matter in the text; its words or figures should not be huddled to indistinctness, as they must be when column rules are allowed to crowd too closely against the words or figures—a common practice, sure to produce confusion. Allowance should be made wherever it is possible for a space between rule and figure.

Before a column rule can be cut, the longest column of type should be set. If each column requires a short cross-heading in small type, this cross-heading should be set up, with a proper blank on each side of the cross-rule, and a similar blank at the head and foot of the full column where it will be separated from the text by the broad cross-rule of the full width of the measure. If this column is one of a series of two or more columns in the same table that is to be surmounted by a broader cross-heading, a similar allowance must be made for the space that will be occupied by the words of that heading and its cross-rule.

Next, compute the width of the brass rules (including the border rule, if one is required) that will be needed to separate the columns.¹

When it is found after proper calculation that the figures and words of a table cannot be got in

¹ This can be done by mental calculation: six 2-point rules will make 12 points thick, two border rules of 4-point will make 8 points, or 20 points in all, and this will narrow the space for the figures or words of the table by 20 points, or two long-primers.

the prescribed space without the crowding of rules close to words or figures, thereby making the table hard to read, two alternatives are presented: a smaller type must be used, or the table must be enlarged, so that it can be read the long way of the page or across two facing pages. Space should be preserved on each side of the column rule wherever it is possible. More than any other characters in the font, figures need space for legibility, and this space is also needed at the head and foot of every distinct column. A table is unsightly when its cross-rules crowd on letters; it suggests neglected calculation.

Every column rule should extend from the broad-measure cross-rule at the top of the table to the broad cross-rule at its foot, if one is used. It should go between column headings in small type. It is a common practice but it is not good workmanship to use a broad-measure cross-rule below the column headings, for it divides the table in two sections.

The thick double-rule border around a table has been supplanted in most printing-houses by a firm border line of 1-point face on a 4-point body. This 1-point face should be flush with one side of the rule, so that a perfect joint can be made at the corners of a table without mitring. The upright column rules and the cross-rules of column headings will fairly meet the border rule and prevent the unpleasing gap of white that was unavoidable when the face of the border rule was centred on its body.

Each column should be made up, when it can be done, to even ems of the type that will be used in the table, for it is often necessary to extend the column by leading. To cut short leads for leading out figures in a measure of two, three, or four ems is always a risk. The leads may not be absolutely uniform in thickness; they may be of uneven thickness by more or less use, or they may be bent in cutting, or be cut with rough edges. The en quadrats or three-to-em spaces of the type selected for figures will separate lines with more evenness than cut leads, and will give less annoyance to the maker-up and electrotyper.

Columns made up of irregular widths and not to even ems of the type are leaded and justified with needless trouble. In some instances thin leads or strips of paper have to be added to make solid work.¹

In a table that has to be put within too small space, as in time-tables, census reports, and work of like nature, the crowding of column rules against figures is unavoidable, but in the occasional tables of good book-work pains should be taken to prevent this crowding. The words and figures of a table should have at least as much distinctness as the roman type of the text.

¹ In the table on the next page the columns of figures on 8-point body are each of three ems width, and the first column is of ten ems width. They are more quickly and securely justified with en quadrats than with leads. The

8-point figures with fair amount of space between lines and rules are more readable than would be 10-point figures that had to be set solid and crowded close up to the column rules. It is the white space that gives legibility.

The relation that one body bears to other bodies in a composition of 1000 ems solid: showing the gain of ems in a prescribed space by a change from a larger to a smaller body, and the loss of ems by a change from a smaller to a larger body. Calculations made for bodies on the American point system.

1000 ems.	12 point Pica.	11 point Small-pica.	10 point Long-primer.	9 point Bourgeois.	8 point Brevier.	7 point Minion.	6 point Nonpareil.	5½ point Agsie.	5 point Faat.	4½ point Diamond.	4 point Brilliant.	3½ point	3 point Ezebier.
12-point Pica	1000	1190	1440	1778	2250	2939	4000	4760	5760	7111	9000	11755	16000
11-point Small-pica	840	1000	1210	1494	1891	2469	3361	4000	4840	5975	7563	9878	13444
10-point Long-primer	694	826	1000	1235	1563	2041	2778	3306	4000	4938	6250	8163	11111
9-point Bourgeois	563	669	810	1000	1266	1653	2250	2678	3240	4000	5063	6612	9000
8-point Brevier	444	529	640	790	1000	1306	1778	2116	2560	3160	4000	5224	7133
7-point Minion	340	405	490	605	766	1000	1361	1620	1960	2420	3063	4000	5444
6-point Nonpareil	250	298	360	444	563	735	1000	1190	1440	1778	2250	2939	4000
5½-point Agsie	211	250	303	373	473	618	840	1000	1210	1494	1891	2469	3361
5-point Faat	174	207	250	309	391	511	694	826	1000	1235	1563	2041	2778
4½-point Diamond	141	167	203	250	316	414	563	669	810	1000	1266	1653	2250
4-point Brilliant	111	132	160	198	250	327	444	529	640	790	1000	1306	1778
3½-point	85	101	123	151	191	250	340	405	490	605	766	1000	1361
3-point Ezebier	63	74	90	111	141	184	250	298	360	444	563	735	1000

Complaint is often made that the time-tables of railroads are hard to read even when their figures are of good cut. They are made indistinct, in many instances, by the selection of too large figures that fill the body with a needlessly bold and black face, and that crowd against each other and the side-rules. Bold-faced figures need space for their distinctness. The selection of a smaller figure that gives a sufficient relief of white between the lines will make the table more readable.

The composition of column headings is always troublesome. In some headings the words will be short and in others very long. They are read with most facility when set to parallel the lines of the table. To do this, abbreviations have to be used occasionally, but this treatment is always a misfortune. Very small type is the preferred alternative, but long words in a column two or three ems wide and parallel to lines of figures are sometimes impossible. For headings of this nature the small type must be set in a wider measure to greater length, and be arranged at right angles with the lines of figures. The length of the measure to be used must be that of the heading that has most words. In the ordinary table, the matter so set should be placed over the column to read up, not down. To insure exact justification, the width of column headings of many words set sidewise should be tested in a stick made up to the exact width of the column.

*Statistics of book- and job-printing in twenty cities of the United States.
Census of 1900, vol. ix, p. 1084.*

Cities.	Population.	Number of estab- lishments.	Capital.	Salaried offi- cials, clerks, etc.		Wage-earners.		Miscellaneous expenses.	Cost of materials used.	Value of Products.
				Number.	Salaries.	Average number.	Total wages.			
New York, N. Y.	3,437,202	996	\$19,107,954	1,552	\$1,689,166	12,857	\$7,730,447	\$4,404,740	\$7,206,921	\$26,484,933
Chicago, Ill.	1,698,575	594	12,540,430	1,816	1,750,818	9,531	4,674,796	2,947,234	4,955,114	18,536,364
Philadelphia, Pa.	1,293,697	401	11,539,833	844	775,094	5,327	2,508,317	1,626,292	2,948,999	10,066,740
St. Louis, Mo.	575,238	173	3,560,128	524	481,141	2,329	1,129,757	648,828	2,016,560	4,420,147
Boston, Mass.	560,892	280	5,870,499	708	582,807	3,077	1,663,282	1,723,336	1,752,274	8,183,215
Baltimore, Md.	508,957	142	1,285,980	148	133,000	1,178	505,903	196,111	690,446	2,037,037
Cleveland, Ohio	381,768	69	1,107,419	150	141,306	981	496,319	117,084	700,052	1,787,106
Buffalo, N. Y.	352,387	87	1,517,303	101	92,661	1,071	522,369	137,789	475,302	1,455,983
San Francisco, Cal.	342,782	105	1,370,577	104	109,514	1,183	667,566	137,002	656,344	2,022,649
Cincinnati, Ohio	325,902	115	1,630,554	127	127,762	1,617	784,122	177,234	866,618	2,513,458
Pittsburg, Pa.	321,616	67	100,015	90	75,076	886	434,481	116,728	513,223	1,396,292
New Orleans, La.	287,104	51	507,670	61	57,218	452	183,062	48,889	150,577	573,987
Detroit, Mich.	285,704	91	927,233	426	165,476	831	394,301	128,950	383,633	1,417,275
Milwaukee, Wis.	285,315	58	746,478	59	57,924	562	225,622	65,785	242,234	750,896
Washington, D. C.	278,718	76	3,139,046	164	211,277	4,101	3,236,730	113,580	1,367,668	5,107,905
Newark, N. J.	246,070	54	624,712	104	89,403	493	203,380	37,570	185,153	674,321
Jersey City, N. J.	206,433	18	454,023	27	29,004	442	175,166	22,195	206,977	488,795
Louisville, Ky.	204,731	45	631,577	60	60,257	601	235,535	59,249	319,998	854,547
Minneapolis, Minn.	202,718	73	474,357	63	57,296	548	253,200	68,706	209,474	770,839
Providence, R. I.	175,597	47	421,297	48	53,539	446	201,182	52,091	250,706	667,328

A table in manuscript with columns too numerous for its fair presentation in the type of the text and in its regular measure may have to be set in a type of smaller size. This is an unpleasant alternative, but if the small type has to be used to get all the columns in the measure, the lines of figures will be made much clearer when they have been leaded with three-to-em spaces or en quadrats. If figures of

*	†	‡		§	¶	⌘	°	/	-	-	-	-	-	-	-	-	-	§	□
1	2	3	4	5	6	7	8	9	0	1	2	3	4	5	6	7	8	9	0
$\frac{1}{4}$	$\frac{1}{2}$	$\frac{3}{4}$	$\frac{1}{3}$	$\frac{2}{3}$	$\frac{1}{8}$	$\frac{3}{8}$	$\frac{5}{8}$	$\frac{7}{8}$.	,									
□	□	□	□	□	□	□	□	□	□						
1	2	3	4	5	6	7	8	9	0										

A useful case for tables of figures.

the text type are insisted on, the table can be set to a wider measure to read the broad way of the page, or it can be made up in two sections to appear on facing pages. It may be that the first column of the table, which explains the figures in each column, will have to be repeated on the second page. It is better to do this than to bewilder the reader with no visible connection between the figures and their explanatory column, or to give unsightly gaps of space between columns.

In extreme cases, each half of the table so divided may be made wider than the regular measure, but each page must be carefully made up so that the two parts will be on exact line in the printed and folded sheet. This method is often unavoidable, but it makes extra trouble for every following workman, from the maker-up to the bookbinder.

Some tables are of great length and have to be continued on many pages, but the general heading and the special cross-headings of each column must be repeated on every page.

Tables that have columns of unequal length, that are sometimes crossed by a diagonal rule, and have a smaller square table within the diagonal blank so created, are always exceedingly difficult. To insure proper solidity, great care must be given to justification.

Another troublesome variety of table is that in which column rules have to be cut in two or more sections to admit one or more long cross-lines of explanatory words. By the old method the column rules were not cut, and single types had to be filed down or spaced out to make them fit in each column. The work could not be neatly done, and this tedious and clumsy method is now out of use.

Needless compactness is a common fault in the occasional tables of a book. Figures, rules, and cross-headings are crowded in too small space, and the table is made repelling to the reader. A table of 6-point figures in a text of 10-point may not be

avoidable when the table must be on the same page as its descriptive text, but this glaring contrast of sizes can be made less offensive by leading the lines of figures and by giving a fair relief of white space to cross-headings. When the text is leaded, the lines of figures in its table should also be leaded wherever it is possible. As the figures occupy in their height about two thirds of the body, while most lower-case letters occupy less than one half of the body, there is more need of space between lines of figures than lines of letters.

An occasional table of two or three narrow columns does not need an inclosing brass-rule border, when this border is made bolder than the figures within. Books of tables that fill the page are now set up by many careful printers without any border. A firm-faced cross-rule under the general heading, without rules on the side or at the foot, is a much more common method.

The type used for column headings should be clear enough in plain roman lower-case letter. To put a heading of one or two words in capitals or title-letter over the broader columns, because there is plenty of space for the words, and to put other headings in very small lower-case letters makes a distinction of display that is not needed by the reader, nor does it improve the typography.

Column rules and cross-rules should be cut so that they will connect with the inclosing border rule. Wood reglet, always too easily compressed,

should not be preferred to fill blank columns. If wood has to be used, the head and foot lines of the column should be of quadrats, that provide a more solid resistance to compression in locking up.

OBSERVATION DE L'INCLINAISON PAR LA MÉTHODE INDIRECTE.							
AVANT LE RENVERSERMENT DES PÔLES.				APRÈS LE RENVERSERMENT DES PÔLES.			
Face à l'Est, 10° 20'		Face à l'Ouest, 190° 22'		Face à l'Est, 19° 22'		Face à l'Ouest, 190° 22'	
Pointe haute.	Pointe basse.	Pointe haute.	Pointe basse.	Pointe haute.	Pointe basse.	Pointe haute.	Pointe basse.
18° 23'	18° 22'	18° 55'	18° 55'	19° 47'	19° 48'	19° 7'	19° 6'
18 28	18 28	18 56	18 54	18 54	19 43	19 13	19 12
18 36	18 35	18 32	18 36	19 40	19 38	19 15	19 14
18 32	18 30	18 42	18 40	19 30	19 30	18 54	18 53
18 28	18 27	18 55	18 52	19 11	19 11	19 0	19 0
18 48	18 45	18 50	18 50	19 8	19 8	19 16	19 14
" "	" "	" "	" "	19 36	19 34	19 19	19 17
" "	" "	" "	" "	19 38	19 38	19 24	19 03
18° 32'	18° 31'	18° 48'	18° 46'	19° 31'	19° 31'	19° 11'	18° 32'
19° 21',0				18° 39',7			

From Lefevre's *Guide Pratique*.

When the different columns of a table are arranged in two or more classes, a thin parallel rule may be used to show more clearly the distinction between these classes. The object of the table is to show figures or words, and not to show the rules. An interior rule that has a line thicker than that of the words or figures detracts from their legibility. The French method of using long brass braces to

connect the different columns of the subheadings shows ingenious composition, but the braces are not of benefit to the reader. The plain hair-line serves a better purpose.

The error made by selecting figures too small and rules and braces too large is evident in this table. If the degree mark and minute mark had been put over their respective columns, figures two sizes larger could have been selected. If hair-lines had been used instead of braces and double rule, the table would have been much more readable.

When a column has figures that require a point to separate dollars from cents or integers from their decimals, the period on the en body, or the en leader, should be preferred. If one on the en body is not to be had, use the regular period of the font, if on the four-to-em body. If the period is on the five-to-em body, justification will be troublesome. The practice of using a space instead of a period to separate dollars from cents is not to be commended. Cents are decimal fractions of the dollar, and the decimal point is needed in every statement that calls for the expression of a decimal fraction. A decimal expression of measurements or values without its point is unmeaning.

It is a misfortune that the dollar mark, the pound mark, and other signs occasionally used in narrow columns are often cast on bodies not easily justified. The en quadrat or the three-to-em space is too thick and the four-to-em space is too thin. All

the sorts needed for table-work should be on bodies that favor perfect justification in the narrowest column.

Table-work is one of the nicest of the compositor's acquirements, and needs careful study and training. Too much stress cannot be laid upon the necessity of accurate casting off and justification, for which exact knowledge of the proportions of types will be of great help. An imposed table should be lifted as securely as a page of text.

MUSIC



The composition of music types requires considerable skill and practice. It cannot be compared with other type composition. The nearest comparison is apparently genealogical work, in which columns have to be made wider or narrower, or table-work, because it has to be cast off; but an expert pedigree-maker in type, or an expert table-hand, would find himself puzzled were he to undertake the composition of music without previous knowledge,—to set it up “out of his own head,” as it were,—as he would if he undertook a difficult problem in the manipulation of letterpress.

A music compositor should have a knowledge of music, in order to give the proper space to each note on account of its value in time, and also the proper place to each music sign. A knowledge of music

would seem to be an absolute necessity. Yet it is a fact that some proficient music composers have no knowledge of music. Intuition governs them. This is mentioned to show that, while knowledge of music is a great help in the setting of music, it is not absolutely necessary. It is no more astonishing than the fact that there are a large number of letterpress composers who have not been properly taught grammar, and yet can set a clean proof from manuscript improperly prepared.

Music type is cast on an em basis, the smallest piece being an en. The lines of the staff are an en, an em, one and a half, two, three, four, and five ems, when cast in metal, but brass lines are now supplied in any length required. The object of having long lines is to have as few joinings as possible, thereby reducing to a minimum unsightly breaks, which appear when the edges of the lines wear away. This used to be avoided when stereotyping by the plaster process was in vogue. A brass rule the length of the line was deftly impressed in each line of the staff in the plaster mould, which gave the plate an unbroken line in each staff. The music published by London (England) firms has often been admired for its even joins. With the advent of electrotyping the practice seems to have fallen into disuse.

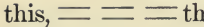
In music composition the lines should be crossed whenever practicable, to avoid the appearance of breaks as much as possible. If they are set like

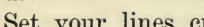
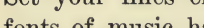
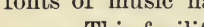
this,  they are more likely to show the divi  sion than this way:  Set your lines crosswise. Some  fonts of music have two lines cast on one body . This facilitates the work, but has its drawback in showing open spaces when worn, besides which, if one line is damaged, the other is of no use. The lengths of the lines have their duplicates in quadrats, which are cast on a single and a double body. Slugs are generally used for over five ems.

The staff is composed with five lines and four spaces, made by the shoulders of the lines; and in order to tell the names of the tones which the notes represent a character called a clef is placed at the beginning. The clef determines the names of the tones on the staff to which it is affixed.

There are three clefs in music; two are fixtures and one is movable. The clefs that are fixtures are called F and G, and the movable clef is called C. Originally the staff was composed of eleven lines. It is now in two divisions of five lines each, called the bass and treble staves, with a line between, which makes up the complement of eleven lines, and this line is called C:



The C clef represents either soprano, alto, or tenor.

The top clef is called G, which gives that name to the second line from the bottom, because the curl of the character encircles it, and the rest of the tones on that staff have their names fixed accordingly.

The bottom clef (bass) is called F, which gives that name to the fourth line, because bounded by the two dots, and which also determines the names of the other tones upon that staff. These two clefs always occupy the same position, but the position of the C clef varies with voice or instrument—tenor or alto, for example. It is generally made of two bars with two lines on each side. The space or line between the bars is called C, which also determines the names of the other tones on that staff.

1. E F G A B C D E

2. D E F G A B C D

3. E F G A B C D E

4. G A B C D E F G

It will be noticed that 2, 3, and 4 differ in their tones, while 1 and 3 appear to be the same. There

is an octave difference, and when 1 is represented by 3 clef it should be played or sung an octave higher. The F and G clefs are cast in one piece, but the C clef is of different pieces:

In some fonts the double bars on each side are cast in one piece on a two-line

body \sharp . This would require only half the number of pieces $\sharp \blacksquare \sharp$.

The key to $\sharp \blacksquare \sharp$ the music is called the signature, which is composed of either sharps or flats, and is placed next to the clef. The signature indicates that notes upon the line or space of the sharp or flat shall be performed sharp or flat accordingly, unless the order is countermanded by a natural \natural :

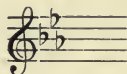
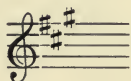



Three sharps after the clef take up three ems space, while three flats take up only two and a half ems, an en only being required between B and A flat, each two lines deep, but a line sharp is three lines deep, sometimes on a two-em kernal body.

Next to the signature comes the time-mark. The C is two ems long and three lines deep. The figures are two ems long on a single body, with a line through them:

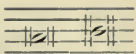
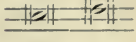
The notes have $\mathbf{1}$ $\mathbf{2}$ $\mathbf{3}$ $\mathbf{4}$ $\mathbf{6}$ $\mathbf{8}$ $\frac{\mathbf{6}}{\mathbf{8}}$ $\frac{\mathbf{6}}{\mathbf{8}}$ two functions — sound and time. The note occupying the longest time (used

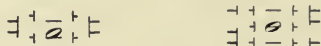
mostly in recitative) is called a breve:  This is made up of separate pieces. A  space note occupies two lines and takes eight pieces, and a line note occupies three lines and takes thirteen pieces, except as shown in preceding page:



The note next in duration of time is called a semi-breve:  being half the value in time of the breve,  as its name denotes. This note is the foundation upon which time is based, and is called a whole note. The note next in order is called a minim, or half note, two of which are of the same value in time as the semibreve. This note, like its predecessor, is white, with the addition of a stem. The notes following are black. Below are given the time values of the notes, those of greatest value being placed on the under or bass staff:



Each additional tail decreases the value of the note one half. Allowance will have to be made when casting off a brace. A brace is more than one line played or sung in unison. A dot added to a note

increases its time value one half, and a second dot is half the value in time of the preceding dot:

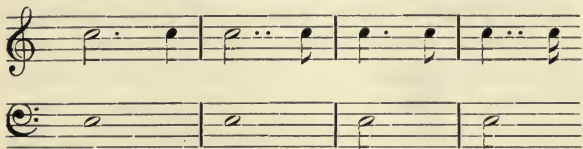

With the exception of the semibreve (or whole note), the notes are composed of different pieces—heads, stems, tails (sometimes called hooks), and ties. The noteheads occupy one line, the space notehead being kerned and resting on the shoulder of the line next to it, except a unison notehead in the space, a connecting notehead in the space, and a B and D notehead in the space, which are generally cast on a double body. The B notehead is the note in the first space outside the staff, with the stem outside the staff. Its name distinguishes it, and its position gives the name to its tone. The notes outside the staff are called leger notes, and are distinguished by a thicker line in some fonts. An en line extends beyond the note each way. Noteheads in the space, on a two-em body without the top line, are called D noteheads. Note the difference:

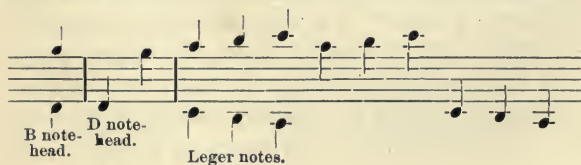

The stems of the notes are on single and double bodies, sometimes three bodies deep. The single-body stems are called angles or T pieces, and are en, em, one and a half ems, two ems, and longer. The double-body stems begin at an em and proceed the same as the single body. They take different forms for use inside and outside the staff, and are manipulated in quite a number of different ways:

	Full.	Cut.		Full.	Cut.
Angle:	┌	┐	Double body:	┌	┐
	Full.	Cut.	Plain stems:		
B stems:	┌	┐			

HOW A NOTE IS MADE

Space.	Line.	Together.	Space.	Line.	Together.
Line.	Space.	Together.	Line.	Space.	Together.

A line notehead stem is longer than a space notehead stem. The space notehead has part of the stem attached, and this equalizes the length.

When notes are grouped they are either tied or bound by a curve. The ties are both straight and slanting, and are joined to the stems of the notes. The bind is to prevent accent, and this is accomplished by making a sustained passage begin with an unaccented note and finish on an accented one,

which prevents or destroys the accent. This is called syncopation. Accent, if not the most important, is one of the most important features in music. Good rendition cannot take place without its being observed. It is equally important with time. It is as important as punctuation in reading-matter or inflection in oratory. Take a passage in common time, the accent being on the first and third beats :

Accent. Accent. No accent. Accent. Accent. Accent.

Bind.

Ties range one em, one and a half, two, three ems, are cast for line and space notes, the line notehead ties being kerned or overhanging, and join each other in diagonal line when up or down. They are up, down, and straight, inside and outside the staff, and combinations can be made in a number of ways, depending upon the skill of the compositor :

Apart. Together. Apart. Together.

When notes ascend or descend in thirds or more, double slants are used, the slope being more acute. When not provided, they can be made by using two $1\frac{1}{2}$ slants, if the space and note occupy three ems :

Apart. Together.

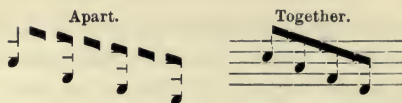

By the use of slurs, notes glide into each other. They are cast in two, three, four, and six ems, and can be made longer, when required, by using combination pieces. When slurs longer than those furnished are required, the end of a bind is used, middle pieces being added to make it of the required length, the last one being tapered for the purpose :

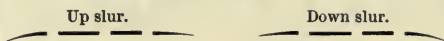

Binds are sometimes called ties and straight slurs. The word bind is used because they do not touch the notes ; the ties touch the notes. They can be made to extend any length and are in one piece up to six ems—two, three, four, and six ems. End pieces are two and four ems long, the middle pieces ranging en, one, two, three, four ems. Like other sorts, they are cast with the line and without :



Music composition cannot be set at random, like type composition. It has to be cast off before it can be constructed, the work of which, in difficult parts, gives the compositor an opportunity to demonstrate his ability or show his lack of it.



The preceding illustration shows a line of music copy that ends at the last bar but one. Music is cast off by ems of its own body. The first thing to ascertain, on taking copy, is the length of the line in music ems. The foregoing line consists of forty-five ems of music. In order to find how to make it come out even, and at the same time to be correctly spaced, find out how much space your noteheads, signature, time-mark, and clef will take up, and then properly distribute the rest of the space. In casting off, give most space to the notes of long duration and economize on the ones that are tied. For example, more space should be placed after a half note than a fourth, etc. In the preceding line the clef is three ems, signature two ems, time-mark two ems, and ten noteheads of one em each. Thus:

	Ems	
This accounts for thirty-five, leaving ten ems to be distributed. One em put before the time-mark, two after it, an em extra in front of bars, and three ems after the last note, including the end bar, will make up the required number—forty-five ems.		Clef, 3
		Signature, 2
		Time-mark, 2
		Ten noteheads, } one em each, }
		10
		—
		17
		Nine spaces between } the noteheads, } two ems each, }
		18
		—
		35

When possible, have the most space in front of the bar. Another way to cast off is to set a guide-line of noteheads, making the spaces between with lines or quads. This is

easier than mental calculation and is done as follows, the noteheads being at the top of the staff :

3 2 1 2 2 1 2 1 1 1 1 1 2 1 1 1 1 1 2 1 1 1 1 1 2 1 1 1 1 1 2 1 1 1 1 1 2 1 2 1

Brass rule is sometimes used for bars, as seen in five previous examples. Bars can be ordered from the type-founder or made in the office. Equivalent spaces have to be used to justify when the bar is not length of line or brace. They are made of various lengths, and should go the depth of the line or brace.

The rests are in one piece and are cast without and with the lines of the staff. The bar or whole-note rest is a straight black line, and is used downward on the top line but one. It is also used for the half-note rest, and is then turned upward and rests on the third line of the staff. The rests are :

Bar or Whole rest.	Half rest.	Quarter rest.	8th rest.	16th rest.	32d rest.

Grace-notes have a smaller face, are duplicates of the other notes, and are manipulated in the same way, many of the sorts, such as accidentals, etc., being on an en body.

Where terms are expressed in words they can be set in any type and justified. When expressed by characters they will be found cast with the font.





















































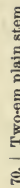
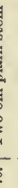
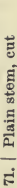

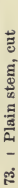

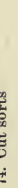

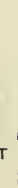

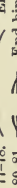
The following plans of cases provide for all the sorts that are necessary for general use. A side box for double quads will be necessary, and also a rule case if brass lines longer than five ems are used. Music fonts vary, and the lay of the case has to vary with them, but the accompanying plans will be found to meet all needs, so that the encumbrance of a third or side case is obviated. The vacant boxes can be utilized as occasion requires. An extra case can be used for the overflow or surplus sorts. All the characters treated are in all fonts cast by American type-founders. Different plans of music cases can be had. The cases here shown can be had through any type-foundry, but special care should be taken to obtain the ones here illustrated. An ordinary lower case and a triple upper case can be arranged for the purpose. Fonts vary as regards number of characters. Cases also vary in the way they are laid, each compositor having his own method. The accompanying plans are made to facilitate composition — noteheads, stems, ties, binds, slurs, lines, etc., being grouped. The aim of the writer has been to simplify the instructions needed. If these instructions are studied and thoroughly understood, the minor difficulties that appear in practice can be readily overcome by a compositor of ordinary ability.

Gregorian music, so named after its founder, St. Gregory, and used for chanting, is composed of one staff of four lines. It hardly comes within the

UPPER CASE

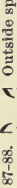
- | | |
|---|---|
| <p>1-4. Up slurs, on line
 5-8. Down slurs, on line
 9-12. Up slurs, out of staff
 13-16. Down slurs, out of staff
 17-20. Binds, on line
 21-24. Binds, out of staff
 25-30. Time marks
 31. Repeat mark
 32. Trill mark
 33. <i>tr</i> Trill
 34. <i>Pedal.</i> Pedal mark
 35. * Pedal star
 36. <i>f.</i> Dal segno mark
 37-38. Common time marks
 39. Coda mark
 39. Turn mark, on line
 40. Turn mark, on space
 41. Turn mark, out of staff
 42. Shake mark, on line
 43. Shake mark, on space
 44. Shake mark, out of staff
 45. Shake mark, line
 46-55. Small figures, outside
 56-60. Small figures, on line
 61. Hold mark
 62-63. Explosives
 64-65. Crescendo marks
 66-8, 74-6, 82-4. Down-slanting ties
 69-73, 77-81, 85-9. Up-slanting ties</p> | <p>90-94. One-em up ties
 95-99. Down ties
 100-101. Thumb marks, line and outside
 102. Up slur
 103. Down slur
 104. Arpeggio mark, line
 105. Arpeggio mark, outside
 106-7. Double sharps, space and line
 108-9. Staccato marks, outside and line
 110-111. Sharps, line and space
 112-113. Flats, line and space
 114-115. Naturals, line and space
 116-117. Flats, line and space, cut
 118. Natural, line, cut
 119. Sharp, line, cut
 120-121. <i>f f</i> Forte marks, outside and line
 122. <i>ff</i> Fortissimo mark
 123-124. Piano marks, outside and line
 125. <i>m</i> M mark
 126. <i>r</i> Rit. mark
 127. <i>z z</i>
 128. <i>s s</i></p> |
| <p>129. Half-body line
 130. Tie, joining
 131. Tie, outside
 132, 137. Grace notes, line
 133, 138. Grace notes, line, joining
 134, 139. Grace notes, space
 135, 140. Grace notes, space, outside
 136. Grace note, space, discord
 141-142. Whole notes, line and space
 143. Half-body space
 144. Line stem, cut
 145. Stem, outside
 146. Up tie, grace note
 147-148. Down ties, grace note
 149. Grace note hook, inside
 150. Grace note hook, outside
 151. Grace note, 16th, up tie, outside
 152. Grace note, 16th, up tie, inside
 153. Grace note, 8th, up tie, inside
 154. En dot, on line
 155. Grace note hook, inside
 156. Grace note hook, outside
 157-8. Grace note sharps, line and space
 159-60. Grace note flats, line and space
 161. Grace note natural, line
 162. Grace note natural, space
 163-164. 16th rests, inside and outside
 165. Half-body line</p> | |

LOWER CASE

- | | |
|---|---|
| <p>3-12, 15.  Straight ties</p> <p>13-14.  Double straight ties</p> <p>16.  Angle, or T-piece</p> <p>17.  Half and whole note and bar rest</p> <p>19.  Outside quarter rest</p> <p>20.  Outside eighth rest</p> <p>21.  Inside quarter rest</p> <p>22.  Inside eighth rest</p> <p>23-29.  Lines</p> <p>30.  En quad, double body</p> <p>31.  En quad, single body</p> <p>32.  En quad, double body</p> <p>33.  Em quad</p> <p>34.  Em and en quad, single body</p> <p>35.  Em and en quad, double body</p> <p>36.  Two-em quad, double body</p> <p>37.  Two-em quad, single body</p> <p>38.  Three-four- and five-em quads, single body</p> <p>39.  White notehead, on line</p> <p>40.  White notehead, on line, connecting</p> <p>41.  White joining space note</p> <p>42.  White joining space note, connecting</p> | <p>43.  White space note</p> <p>44.  White outside note</p> <p>45.  Three-quarter space</p> <p>46.  Three-quarter line</p> <p>47.  Double en angle</p> <p>48.  Black notehead, on line</p> <p>49.  Black notehead, on space</p> <p>50.  Joining line notehead</p> <p>51.  Space discord notehead</p> <p>52.  Unison line notehead</p> <p>53.  B notehead</p> <p>54-56.  Angles</p> <p>57-59.  Two-line stems</p> <p>60-61.  Two-line stems, cut</p> <p>62-65.  Angles, cut</p> <p>66.  Inside dot</p> <p>67.  Outside dot</p> <p>68.  Unison notehead, in space</p> <p>69.  Unison notehead, in space, cut</p> |
| <p>1.  Common bar</p> <p>2.  Heavy bar</p> | <p>70.  Two-em plain stem</p> <p>71.  Plain stem, cut</p> <p>72.  One-em plain stem</p> <p>73.  Plain stem, cut</p> <p>74.  Cut sorts</p> <p>75.  B stems</p> <p>76.  B stems, cut</p> <p>77-78.  End binds, plain</p> <p>80-81.  End binds, on staff</p> <p>82.  Middle pieces</p> <p>83.  One-em line hook, outside</p> <p>84.  Em and en line hook, outside, cut</p> <p>85-86.  Line hooks, cut</p> <p>87-88.  Outside space hooks</p> <p>89-90.  Line hooks, outside</p> <p>91.  Line hook</p> <p>92.  Space hook</p> <p>93.  Line hook</p> <p>94.  Space hook</p> |
| | <p>95.  Treble clef</p> <p>96.  Bass clef</p> |
| <p>18.  Middle bar</p> <p>79.  Middle pieces of binds, plain</p> | |

category of music composition as generally understood, having none of the difficulties of building or ranging that are encountered in the old notation. The compositor sets up the line of words first and ranges the notes over them. No casting off is required. It is comparatively straight matter. Previous knowledge is not necessary, and any average compositor can set it. The noteheads are diamond and square shaped, and the ordinary music stems are used.

In tonic sol-fa music no staff is used, letters taking the place of notes. Each part occupies a line, the pulses or beats being divided by colons, and the subdivisions by periods and commas, except where the accent occurs, when an inverted one em dash is used. When more than one part is engaged, the beats have to range. Brass rule the depth of the vocal parts is used for bars. Thus, do, re, mi, do, in common time, would be d₁: r | m: d¹ | . The inferior stroke at the first d signifies an octave lower, and the superior stroke at the last d an octave higher. Music character expressions are used. It is intended only for the voice, the instrumental accompaniment having to be set in the old notation. The characters are on en and em bodies. Having no staff, the difficulties of building have not to be contended with, making the casting off comparatively easy, and the composition virtually straight matter, like setting a line of figures across a table, through which may be inserted the column

rules. It can be done by one who can set a table. The following is an illustration and will speak for itself :

KEY E ζ .	<i>Alto, tenor,</i>	<i>and bass.</i>	s	:	fe	l	:	s	s.d'	:	r'.d'	d'	:	t
			1. Gen - tly,		gen - tly	2. Mirth and		mu - sic	morning light is break - ing,		like a fountain flow - ing,			
			m	:	re	f	:	m	m.m	:	f.m	m	:	r
			d	:	d	d	:	d	d.d	:	d.d	s ₁	:	s ₁

Diamond and excelsior music type are best suited for book-work. Excelsior occupies the least space. Diamond has three sizes of noteheads, Nos. 1, 2, and 3. Other fonts are also supplied with different sizes of noteheads.

GENEALOGIES AND PEDIGREES

The intent of the genealogical chart is a synopsis of descent and of mutual relationship that will be understandable at a glance. The lines that show connection with near or remote ancestry should be plain hair-line brass rules; if, now and then, a brace may be needed, it should be of light face. The words are of most importance, and should not be made insignificant by blackness of braces. To present each member of the family in column form, and to preserve a proper parallelism of columns, these columns must be of unequal width, some very narrow and some very broad; one may have but three or four words, and another may have fifteen

PEDIGREE OF THE

BUDDHIST BIRTH-STORIES.

SAN

KARATA

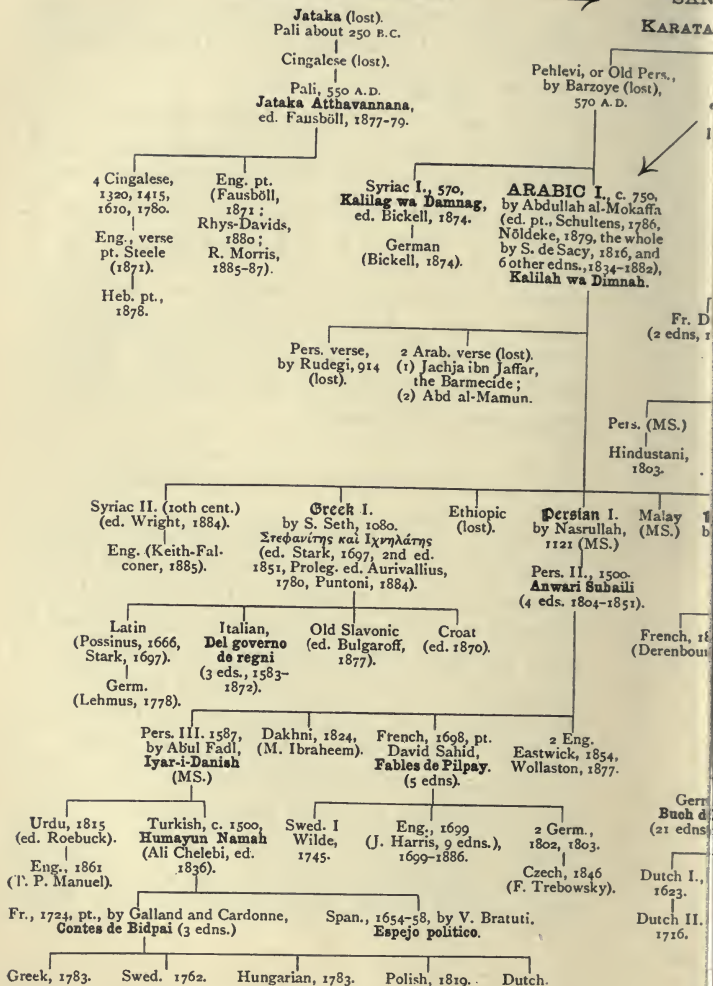

BIDPAI LITERATURE.

ERIT I., abt. 300 A. D.

and **DAMANAKA** (lost).

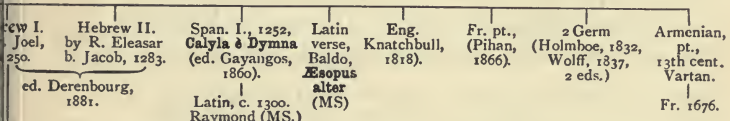
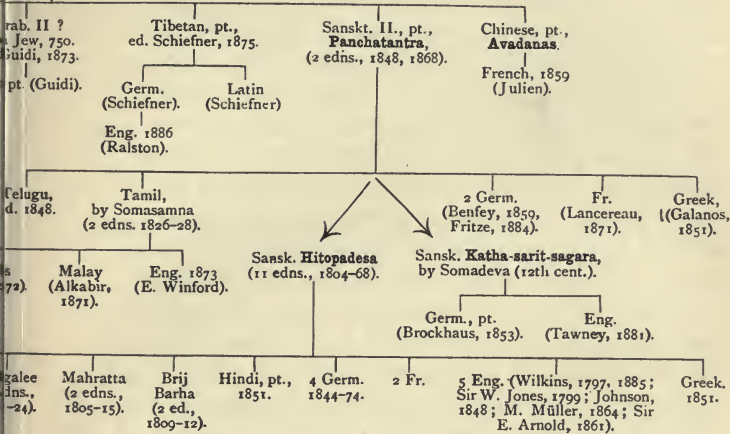

LATIN I., by John of Capua, 1270.
Directorium vite humane (ed. 1483; Puntoni, 1884; Derenbourg, 1887).

ed. pt. E. du Ménil, 1854.



or more. Unlike all other forms of type-setting, the building of a long genealogical chart cannot begin at the beginning of the manuscript. It must begin with the columns that occupy greatest width, which are usually at or near the foot of the chart. Each column should be separately set, accurately justified, and kept dampened so that it can be easily handled, for interlockings and rearrangements are unavoidable. The process of building up separate rows of matter for different generations has to be done in reverse order, the matter first written being the last set. For obvious reasons, the genealogy of a family is not offered as an illustration, but the *Pedigree of the Bidpai Literature*,¹ which is a story of the origin and descent of a famous book, fairly shows the method used in the composition of the genealogies of families. It may be added that no form of typographic composition is more

¹From Joseph Jacobs's Earliest English Version of the Fables of Bidpai, post 8vo, London, 1888.

A more carefully elaborated genealogical chart is that of the Estienne (Stephens) family of Paris, as it is presented in the *Essai sur la Typographie*, by M. Ambroise Firmin-Didot, 8vo, Paris, 1851, which begins with Pierre Estienne (1270), and is continued through sixteen generations. Yet it is compacted upon a sheet 13 × 17½ inches. The composition is apparently in type on 4½-point body. Each member of the family is speci-

fied within a border printed in blue ink, but the braces that show connection are in red ink. The chart is inclosed in a border of fifty-eight heraldic shields, each one presenting the peculiar device of a different member of the family.

A simpler form of chart can be seen in *Les Elzevier*, by Alphonse Willems, 8vo, Brussels, 1880. It is for five generations only of that family, and is printed in red and black, on a long sheet 9½ × 20½ inches. All are admirable as illustrations of difficult composition.

troublesome or more expensive than that of the genealogical chart.

The genealogical chart in manuscript that has to be kept within a prescribed limit cannot be properly set if the copy has not been prepared in an orderly manner. If a distinct column has not been made for each member of the family, and the relation of different members to their co-relatives and to the common ancestor is not clearly defined, it will be a waste of time to try to put in type copy so negligently prepared. The matter should be rewritten, and it may be prudent to rewrite it more than once before the mutual relation of the different members of that family can be fairly presented.

In genealogical charts the name of the ancestor is at the head of the page, and the descendants are set below in rows that are nearly parallel. In the pedigrees of animals the name of the progenitor

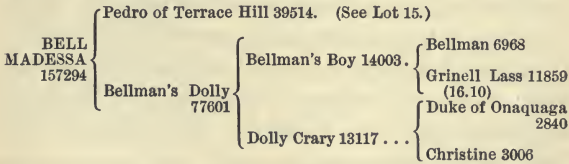

and the names of his descendants usually are composed in separate columns with proper separating blanks, after the fashion customary in some tables of figures, detachable braces being substituted for plain column rules. The column that contains the last generation at the end of the measure is often

very compact; the name of the progenitor at the left in the first column is open, with a broad blank above and below. This method of treating a pedigree is sufficient for three or four generations, but it is not so practicable on the ordinary page when the columns are continued at great length.

Some text-books of chemistry make use of this method of composition to illustrate the compounds and subcompounds of elementary substances. It is also used in botany to show the classification of species derived from a common stock. The method makes the subject-matter much more intelligible.

Some of the older forms of troublesome composition have been discarded: the chronogram, in which dates were suggested by roman capital letters arbitrarily arranged as numerals; acrostics with initial letters turned sidewise; literal or verbal puzzles produced by signs; diagrams toilsomely constructed from brass rules ingeniously curved and twisted; facs, head-bands, and initials of combination borders or capital letters; stigmatypes of portraits made from periods of different size. Prints from these compositions suggest skill and patience, but the general effect is not pleasing. It is a mistake to try to do by typography anything that can be done more neatly and quickly by photo-engraving. Composition should exemplify its etymology, not by the construction but by the combining of its materials.



SAMUEL NELSON DICKINSON

VI

FOREIGN LANGUAGES

Accents . . . Greek . . . Hebrew . . . German



FOREIGN languages will be set with most correctness by the compositor who clearly understands the meaning of his copy, but a knowledge of more than one language is not to be expected of the ordinary typesetter. Reprint or clear manuscript copy in Latin, French, Spanish, Italian, or in any other language that uses the roman character, can be decently rendered in type by a careful compositor, but the difficulty of preserving accuracy increases when the copy is in Greek, Hebrew, or German, for each one of these languages has its own peculiar alphabet.

Yet Greek, Hebrew, and German characters must be provided for the proper rendering of quoted words or lines in every printing-house that undertakes to do miscellaneous book-work.

The characters required for the languages that have distinct alphabets are seldom found in the ordinary book-house. To employ them acceptably, fonts of many faces and sizes must be provided, and they should be handled by compositors and supervised by readers who have at least some superficial acquaintance with the languages.¹

ACCENTS

One peculiarity of printed English language is the absence of accented letters in an ordinary descriptive text. It is only in dictionaries or elocutionary

á à â ã ä å ä ã ä ã ä ã ä ã ä ã ä é è é ë ê ë ë é í î ï ï ï ï ï ó ò ö ö õ
 ǒ ȩ ȩ ȩ ȩ ů ú û ü ů ŭ ŭ ŭ ŭ ŷ ŷ ŷ ŷ ŷ ç é ð ñ ñ ů s t z x
 Century Dictionary accents.

treatises that accents are freely used to guide pronunciation. English-speaking compositors are apt

¹ There are but few printing-houses of polyglot capability. Those that have justly earned a world-wide reputation are the University Press of Oxford, England, the National Printing House of Paris, De Propaganda Fide of Rome, the Imperial Printing House of Vienna, and W. Drugulin of Leipsic, Ger- many. In all large cities may be found occasionally printing-houses that have one or more fonts of Arabic, Turkish, Syriac, Coptic, Russian, Sanskrit, and other Oriental languages, but they are used infrequently, and the ordinary book-printer has to decline the purchase of types that will be rarely used.

to underrate the importance of a proper placing of accents in the composition of foreign languages, where the same word with or without an accent may convey a different meaning. American type-founders provide and furnish, but only on special request, these accents¹ for roman letter :

Bohemian : Á Č Ď É Ě Í Ň Ó Ř Š Ť Ú Ů Ý Ž
á č ď é ě í ň ó ř š ť ú ů ý ž

Danish and Norwegian : Ø ø

Flemish : É Ê Ë é ê ë ó

French : À Â É È Ê Ë Î Ï Ò Ù Û Ç à â é è ê ë î ï ô ù û ü ç

German : Ä Ö Ü ä ö ü

Hungarian : Á É Í Ó Ö Ő Ú Û Ű á é í ó ö ő ú ü ű

Italian : À È Ì Ò Ù à è ì ò ù

Polish : Ą ą Ć Ć É Ę Ł Ó Ś Ź Ż ą ć é ę ł ó ś ż

Portuguese : Á Ā É Í Ó Ō Ú Û Ñ Ç á â ã é í ó õ ú ü ñ ç

Spanish : Á É Í Ó Ú Û Ñ á é í ó ú ü ñ

Swedish : Å Ä Ö å ä ö

Welsh : Ŵ Ŷ and the ordinary accents

¹ This list is incomplete. Some forms of Italian poetry require a special accent known as *trema*. Rumanian needs many accents peculiar to that language, but as yet not made in this country.

The roman character predominates in Saxon and Irish, but their alphabets have some letters that are intelligible to educated readers only. They are occasionally used in treatises on etymology, and are to be had of the old-

established English type-foundries. For the most part, accents and points are not sufficiently distinct. The Masoretic points of Hebrew and the breathings of Greek are relatively feeble. This feebleness seems unavoidable in accents that have to be attached to roman capital letters, where the character extends to the extreme top of the body. In many fonts accents for capitals have to kern or overhang the body.

GREEK

The Greek alphabet has twenty-four capital letters, but the ordinary working font of Greek type has one hundred and seventy-four distinct characters. Some European type-founders provide a greater number. Many of the Greek capitals are of the same form as roman capitals, but the lower-case letters differ seriously and are not easily understood by the novice. All fonts of Greek made before the eighteenth century contain many doubled letters, then known as ligatures or tied letters.¹

A manuscript in Greek calls for careful penmanship. Each letter should be formed with distinctness and the accents unmistakably placed over their proper vowels. Extracts pencilled in Greek books printed before the eighteenth century are bewildering to the modern compositor by reason of their frequent use of the sigla and ligatures that are no longer made in type.

¹In his *Manuel Typographique* (tome 2, p. 248), Fournier shows seven hundred and seventy-six distinct characters in his provision for a perfect font of Greek type, but he says that he has not made as many as his predecessors. Savage's *Dictionary of the Art of Printing* (pp. 300-302) gives a table of some of the more common ligatures, but the Greek grammars of the eighteenth century have more com-

plete lists. An explanation of many of these ligatures will be found in *Dizionario di Abbreviature Latine ed Italiane*, by Adriano Capelli. Although this dictionary professes to treat of Latin abbreviations only, it is of some service for Greek. These ligatures are not made by modern type-founders, but the accents and breathings are still retained as indispensable parts of the perfect font.

The Greek alphabet

Capitals	Lower-case	Name	Power	Value as numerals
A	α	Alpha	<i>a</i>	1
B	β β	Beta	<i>b</i>	2
Γ	γ	Gamma	<i>g</i>	3
Δ	δ	Delta	<i>d</i>	4
E	ϵ	Epsilon	<i>e</i> short	5
Z	ζ	Zeta	<i>z</i>	7
H	η	Eta	<i>e</i> long	8
Θ	θ ϑ	Theta	<i>th</i>	9
I	ι	Iota	<i>i</i>	10
K	κ	Kappa	<i>k</i> or <i>c</i>	20
Λ	λ	Lambda	<i>l</i>	30
M	μ	Mu	<i>m</i>	40
N	ν	Nu	<i>n</i>	50
E	ξ	Xi	<i>x</i>	60
O	\omicron	Omicron	<i>o</i> short	70
Π	π	Pi	<i>p</i>	80
P	ρ	Rho	<i>r</i>	100
Σ	σ ς	Sigma	<i>s</i>	200
T	τ	Tau	<i>t</i>	300
Υ	υ	Upsilon	<i>u</i>	400
Φ	φ	Phi	<i>ph</i>	500
X	χ	Chi	<i>ch</i>	600
Ψ	ψ	Psi	<i>ps</i>	700
Ω	ω	Omega	<i>o</i> long	800

Accents and breathings are attached to the lower-case letters where they are needed, but they are also cast on separate bodies, so that they can be put before a capital letter. The vowels $\alpha \eta \omega$, with subscript iota indicating the suppression of a following ι , may be considered distinct characters, but they are seldom used. There are also two forms of lower-case letters $\beta \beta$, $\theta \vartheta$, $\sigma \varsigma$.¹

Greek accents

' lenis	" asper grave
˘ asper	˜ circumflex
´ acute	˘ circumflex lenis
` grave	˘ circumflex asper
˘ lenis acute	¨ dieresis
˘ lenis grave	ˆ dieresis acute
˘ asper acute	ˆ dieresis grave

The comma, period, and exclamation-point perform the same function in Greek as in English. The Greek mark of interrogation is the English semicolon, sometimes reversed. The Greek colon is an inverted period.

A study of the Greek alphabet and of a few rules that control the use of accents and breathings will be of service to the compositor, even if he needs this knowledge only for one paragraph.

¹ The characters β and ϑ are not often required. The final s, at the end of a word, should be ς ; ρ has been suppressed. as an initial or medial letter it should be σ . An old form of

Nearly every word in Greek has one accent, but it has no more than one (except, under certain conditions, before an enclitic).¹

Accents that cannot be put over a Greek capital are on separate bodies and put before the capital.

The acute accent may appear only on one of the last three syllables of a word, the circumflex only on one of the last two syllables, and the grave only on the final syllable. The last is seldom used, except to replace the acute accent in a final syllable before another word in the same sentence.

Every vowel or diphthong that begins a word has either the rough or the smooth breathing over it. The vowel upsilon admits of the rough breathing only. A diphthong takes both the accent and the breathing upon the second vowel. Initial ρ always has the rough breathing; double ρ occurring in a word is written $\rho\rho$.

The hyphen is never employed in Greek for the compounding of words.

The apostrophe is used to mark elision, as in $\acute{\alpha}\nu\tau' \acute{\epsilon}\kappa\epsilon\acute{\iota}\nu\eta\varsigma$ for $\acute{\alpha}\nu\tau\grave{\iota} \acute{\epsilon}\kappa\epsilon\acute{\iota}\nu\eta\varsigma$. It is also (under the name "coronis") used to mark the consolidation of words, with elision, as in $\tau\acute{\alpha}\nu\delta\rho\acute{\iota}$ for $\tau\acute{\omega}\ \acute{\alpha}\nu\delta\rho\acute{\iota}$, $\tau\acute{\alpha}\gamma\alpha\theta\acute{\alpha}$ for $\tau\grave{\alpha}\ \acute{\alpha}\gamma\alpha\theta\acute{\alpha}$.

Sometimes the apostrophe marks the elision of a vowel at the beginning of a word, as in $\acute{\omega}\ ' \gamma\alpha\theta\acute{\epsilon}$ for $\acute{\omega}\ \acute{\alpha}\gamma\alpha\theta\acute{\epsilon}$, but this is most common in poetry.

¹ Theoretically "every word," but it is lost by enclitics and proclitics, and, in some cases, by elision.

The dieresis accent separates two vowels, so that they will not be pronounced as a diphthong: *ἀϋτή* with a dieresis is a word that makes three syllables, but without the dieresis *av* becomes a diphthong and makes of *ἀϋτή* two syllables.

The rules that regulate accents are complex and not to be briefly explained. In different positions the same word may take different accents.

Greek types are made of many faces and on many bodies from diamond to canon.¹ The face most approved in England is known as the Porson, so called from its designer, who was not only great as a scholar, but equally famous as a penman. Old-style Greek has a relatively small face, with quaint forms of lower-case characters that are now disliked by the critical. The form of Greek character preferred in many European countries is compressed a little, and almost vertical in shape. The Greek made by Baskerville is not at all approved by Greek scholars. The fat-faced and bold-faced Greek, or thickened Greek, finds its greatest use for the index words of dictionaries.

Inscription Greek, or lapidary Greek, of rude form and consisting of capital letters only, is used for the proper rendering of old lettering cut on stone. The facsimile, on the next page, of the Greek of Selwyn Image was made for the Macmillan Company.

¹ Pickering's edition, in two volumes, of the Iliad and the Odyssey in diamond Greek is remarkably beautiful specimen of typography. It is probably the smallest form of Greek type ever printed, yet its presswork is wonderfully clear.

Α Β Γ Δ Ε Ζ Η Θ Ι Κ Λ Μ Ν Ξ Ο Π Ρ Σ Τ Υ Φ Χ Ψ Ω
 α β γ δ ε ζ η θ ι κ λ μ ν ξ ο π ρ σ ς τ υ φ χ ψ ω

Porson Greek.

Α Β Γ Δ Ε Ζ Η Θ Ι Κ Λ Μ Ν Ξ Ο Π Ρ Σ Τ Υ Φ Χ Ψ Ω
 α β β γ δ ε ζ ζ η θ θ ι κ λ μ ν ξ ο π ρ ρ σ ς τ υ φ χ ψ ω

Old-style Greek.

Α Β Γ Δ Ε Ζ Η Θ Ι Κ Λ Μ Ν Ξ Ο Π Ρ Σ Τ Υ Φ Χ Ψ Ω
 α β γ δ ε ζ η θ ι κ λ μ ν ξ ο π ρ σ ς τ υ φ χ ψ ω

Title or fat-faced Greek.

Α Β Γ Δ Ε Ζ Η Θ Ι Κ Λ Μ Ν Ξ Ο Π Ρ Σ Τ Υ Φ Χ Ψ Ω
 α β β γ δ ε ζ η θ θ ι κ λ μ ν ξ ο π ρ σ ς τ υ φ χ ψ ω

Continental Greek.

Π Ρ Ι Η Ν Ε Ι Α Μ Ι Ω Ι
 Ε Υ Φ Α Ν Ι Σ Κ Ο Σ Κ Α Ι Δ / . . Ι Ν Ο Υ Κ Α Θ Υ Ο
 Σ Ι Α Ν Δ Ε Ν Ι Κ Α Σ Ι Δ Α Μ Ο Υ Α Γ Η Σ Ι Α Ν Δ Ρ Ο .
 . Υ Δ Α Μ Ο Υ Τ Ι Μ Α Γ Ο Ρ Α Σ Π . . . Α Κ Λ Ε Υ Σ
 . Ω Σ Τ Ρ Α Τ Ο Σ Τ Ε Ι Σ Ν Δ Ρ Ο Σ Π
 . Τ Ω Ν Υ Μ Ο Υ Α Ι Ρ Ε Θ Ε Ν Υ Α Λ

Inscription or lapidary Greek of capitals only.

Α Β Γ Δ Ε Ζ Η Θ Ι Κ Λ Μ Ν Ξ Ο Π Ρ Σ Τ Υ Φ Χ Ψ Ω

Ὅρω μὲν ὧ ἄνδρες Ἀθηναῖοι τὰ
 παρόντα πράγματα πολλὴν δυσκολίαν
 ἔχοντα καὶ ταραχὴν, οὐ μόνον τῷ πολλὰ

The Greek type of Mr. Selwyn Image.

HEBREW

The Hebrew alphabet consists of consonants only, but the addition of points gives to some of them the power of vowels. It is in one series, without difference in form for capitals or lower-case, and has no need for small capitals or for italic. Some of the letters are varied in shape when used as finals. Its numerals, made by arbitrary powers given to letters, are placed in the following table at the end of the lines, opposite their proper letter.

The Hebrew alphabet

Letter	Name	Value	Letter	Name	Value
א	Aleph	1	מ	Mem	40
ב	Beth	2	נ	Nun	50
ג	Gimel	3	ס	Samek	60
ד	Daleth	4	ע	Ayin	70
ה	He	5	פ	Pe	80
ו	Vav	6	צ	Tsadhe	90
ז	Zayin	7	ק	Q'oph	100
ח	Cheth	8	ר	Resh	200
ט	Teth	9	ש	Sin	} 300
י	Yodh	10	ת	Shin	
כ	Kaph	20	ת	Tav	400
ל	Lamedh	30			

242 *Points as guides to pronunciation*

As characters of similar shape may be confounded, some features of difference are explained in the following remarks.

ב	BETH, with a rounded stem at the upper right angle, rests on a long, flat base which projects on the right.	ת	TAV has a rounded angle at the upper right side, and a knob at lower end of left line.
כ	KAPH has a curved line at the side that rests on a shorter base-line that does not project to the right.	ז	ZAYIN has a short top line that projects slightly over the long stem.
ג	GIMEL has an upright slanting line that projects by the side of the base-line, which leaves a small angle at the right.	ו	VAV also has a short top line, but it does not project at all over the stem.
נ	NUN has an upright line that does not project: it meets a short base-line and does not make a sharp point at the right.	ן	NUN FINAL is unlike Zayin in having a very long and slightly bent stem and no projection.
ד	DALETH is a right angle, flat at the top, projecting over its vertical stem to the right.	ט	TETH has a flat base joined to two lines, a curve at right, a knob at left.
ר	RESH, of a similar form, is rounded at the angle that appears at its right and does not project over its stem.	מ	MEM has right stem curved; the left is disconnected at the base, with a knob at the top.
ך	KAPH FINAL, like Daleth, has a projecting angle at top, but has a longer descending stem.	מ׃	MEM FINAL is nearly square at the base-line at right hand.
ה	HE has two stems, slightly thickened; the one at the left is disconnected.	ס	SAMEK has a much shorter base-line.
ח	CHETH has two stems, each one connected to the flat line at the top.	ע	AYIN has two knobby stems sloping to a base-line inclining to left.
		צ	TSADHE, with similar knobby stems, meets a base-line that is horizontal.
		ץ	TSADHE FINAL has a long vertical stroke at the junction of two stems.

The point Daghesh • is cast within the body of certain letters to modify their pronunciation. The point Mappiq • (of same form) is put in the letter ך׃ (He final) to make it retain its harshness as a consonant. Raphe ¯ is a small dash (rarely used), but on a higher plane, that gives an aspirated sound to the letter below. Maqqeph - (of same form) is used as a hyphen to join words together. These are all the characters absolutely needed for

the proper rendering of an ordinary word or line of Hebrew, but for grammatical and theological works many accents must be provided. These accents are cast on small bodies and are placed above or below the type of the text.

ACCENTS PLACED UNDER CONSONANTS

<p>⌋ Silluq, only at the end of the verse, therefore always followed by : Soph-pasuq, which stands between the single verses.</p> <p>^ Athnach, always in the midst of a verse.</p> <p>< Yethibh (always to the right of the vowel).</p> <p>⌋ Tebhir.</p> <p>⌋ Tiphcha initial.</p>	<p>⌋ Merkha.</p> <p>⌋ Double-Merkha.</p> <p>⌋ Munach.</p> <p>< Mahpakh (to the left of the vowel).</p> <p>⌋ Darga.</p> <p>⌋ Yärach.</p> <p>⌋ Tiphcha final.</p> <p>⌋ Metheg, sign of tone (to the left of the vowel).</p>
--	--

ACCENTS PLACED ABOVE CONSONANTS

∴ Segholta.	⌋ Qadma.	⌋ Great-Telisha.
∴ Zaqeph-qaton.	⌋ Pashta.	⌋ Little-Telisha.
⌋ Zaqeph-gadhol.	⌋ Shalshleth.	⌋ Gäresh.
∴ Rebhia.	⌋ Paser.	⌋ Double-Gäresh.
∴ Zarqa.	⌋ Qarne-phara.	

ACCENTS OF TWO PARTS THAT BELONG TOGETHER:

ONE ABOVE AND THE OTHER BELOW CONSONANTS

<p>< Merkha mahpakhatum.</p>	<p>⌋ Merkha sarqatum.</p>
<p>⌋ Mahpakh sarqatum.</p>	

MARKS OF PUNCTUATION

∴ Soph-pasuq, separating verses.	— Maqqeph, hyphen, aloft, between the words.
⌋ Pesiq, between the words.	

MASORETIC POINTS OR VOWELS

The Masoretic points or vowels, ten in number, five *long*, or perfect, and five *short*, or imperfect, are represented by small strokes or points placed above, below, or within the consonants. Examples

of their uses in connection with the letter Beth (בּ בְ) are given below.

Long Vowels under the Consonants

Kamets $\bar{\text{ב}}$ = a as in bar¹ $\bar{\text{ב}}$ or o as in bone²

Tsaray בֵּ = a as in bale² בֵּ or e as in bed¹

Chirek (long when followed by Yodh) בִּ = i as
in bijou בִּ

Long Vowel above the Consonants

Cholem בֹּ or בױ = o as in bowl¹ בױ or ow as in
bow² (curtsy)

Long Vowel within the Letter י

Shurek בײ = u as in Buddha בײ

Short Vowels under the Consonants

Pathach בַּ = a as in bar. When followed by an unvocalized Yodh י it forms with the latter the diphthong ai, pronounced like i in bite בַּי

Pathach furtive בְּ is a Pathach occurring only under the letters ב , כ , and ג , when the letters occur at the end of a word, and is pronounced *before* the consonant under which it is placed.

Segol בֶּ = e as in bet בֶּ

Chirek (short) בִּ = i as in bin בִּ

Kamets Chatuph בֹּ = o as in son or bone בֹּ

Kibuts בֻּ = u as in bull בֻּ

¹ According to Spanish and Portuguese pronunciation.

² According to German pronunciation.

The other vowels are pronounced alike.

SHEVAS

The following Shevas, used here beneath a Cheth (ך), denote that a vowel is wanting.

Sheva (simple) :	as	ך̣	
Chataph Pathach _:	as	ך̣̣	= a
Chataph Segol :::	as	ך̣̣̣	= e
Chataph Kamets τ::	as	ך̣̣̣̣	= o

The last three are short vowels to which the Sheva (simple [:]) is joined, and are known as compound Shevas.

Hebrew is read from right to left. To give to the characters this sequence in print, the types must be reversed after they have been set. The compositor begins as he does with English, by setting the characters at the left hand of his copy, turning the nicks of the type inward to face the composing-rule. When the line has been spaced and justified (wide spacing is preferred), turn the line in the stick. If accents are to be added, justify them in a separate line in their proper places.

Hebrew is laid in the cases by many different schemes, but the scheme here exhibited is the one generally accepted by most of the compositors in America. The characters without points, most used, are in the lower case; accents, finals, broad letters, and letters with points are in the upper case.

א	ב	ג	ד	ה	ו	ז	ח												
א	ב	ג	ד	ה	ו	ז	ח												ט
א	ב	ג	ד	ה	ו	ז	ח			ז	ח	ט	י	יא	יב	יג	יד	טו	טז
א	ב	ג	ד	ה	ו	ז	ח			י	יא	יב	יג	יד	טו	טז	יז	יח	יט
א	ב	ג	ד	ה	ו	ז	ח			י	יא	יב	יג	יד	טו	טז	יז	יח	יט
א	ב	ג	ד	ה	ו	ז	ח			י	יא	יב	יג	יד	טו	טז	יז	יח	יט
א	ב	ג	ד	ה	ו	ז	ח			י	יא	יב	יג	יד	טו	טז	יז	יח	יט
א	ב	ג	ד	ה	ו	ז	ח			י	יא	יב	יג	יד	טו	טז	יז	יח	יט
א	ב	ג	ד	ה	ו	ז	ח			י	יא	יב	יג	יד	טו	טז	יז	יח	יט
א	ב	ג	ד	ה	ו	ז	ח			י	יא	יב	יג	יד	טו	טז	יז	יח	יט

Hebrew upper case.

		□	□	ט	ק					-	·	·	:	·	·	-	□		
ר						ה				·	·	·	·	·	·	·	□	□	□
ס	נ	ד	ד							·	·	·	·	·	·	·	□	□	□
ו		מ	נ	ה						·	·	·	·	·	·	·	□	□	□
ך										·	·	·	·	·	·	·	□	□	□
ץ	ו	ל	ת	□						·	·	·	·	·	·	·	□	□	□
ז										·	·	·	·	·	·	·	□	□	□

Hebrew lower case.

The accents are useful as notes for chanting, or to show nice distinctions in the meanings of words. They have to be separately composed and justified for attachment to the proper character. For the most part, the accents are centred over or under the characters, but when a character has a long leg or stem the accent should be under the leg.

A word in Hebrew cannot be divided by a hyphen so that one part shall be in one line and the other part in the next line. To prevent this fault, and to maintain more evenness in the spacing of words, six Hebrew letters are made of greater width :

Aleph	He	Cheth	Lamedh	Mem	Tav
נ	ה	ח	ל	מ	ת

The characters here shown are the ones used for all ordinary printing in Hebrew. There are other forms, known as Rabbinic and German-rabbinic. Hebrew running-hand is of much simpler form, in which letters with curved lines are substituted for the angled letters, but it can be read and put in type by those only who understand the language.

GERMAN

The German alphabet has nominally twenty-six capital letters, but the same character serves for I and J. The capitals *Ä*, *Ö*, and *Ü* have the umlaut attached to indicate the sounds of *æ*, *ø*, and *uë*. The lower-case series is increased by a distinct character for *j*, and by the addition of thirteen double letters. A font of German has no small capitals, and the use of italic is obviated by the hair-spacing of emphasized words, or by selecting for these words a type of a much bolder or an entirely different face.

The German alphabet

Capitals	Lower-case	Capitals	Lower-case	Name
A	a	A	a	Ah
B	b	B	b	Bey
C	c	C	c	Tsey
D	d	D	d	Dey
E	e	E	e	Ey
F	f	F	f	Ef
G	g	G	g	Gey
H	h	H	h	Hah
I	i	I	i	E
J	j	J	j	Yot
K	k	K	k	Kah
L	l	L	l	El
M	m	M	m	Em
N	n	N	n	En
O	o	O	o	O
P	p	P	p	Pey
Q	q	Q	q	Koo
R	r	R	r	Air
S	s	S	s	Ess
T	t	T	t	Tey
U	u	U	u	Oo
V	v	V	v	Fow
W	w	W	w	Vey
X	x	X	x	Iks
Y	y	Y	y	Ypsilon
Z	z	Z	z	Tset

To the hasty observer some German letters are not sufficiently distinct. To prevent mistakes in selection, the differences between similar characters are here pointed out.

B	B has a central cross-stroke that connects the two stems.	b	b has its shorter stem united to the longer stem at its foot-line.
V	V has no connecting cross-stroke, and shows an open space between stems.	h	h is not so united, and has a hair-line that projects below the foot-line.
C	C has no projection, at the right, from its shorter stem.	f	f has a short central stroke that crosses the upright thick stem.
E	E has a short side-stroke projecting from the middle of this short stem.	s	s has a projecting spur on the left side only of the thick stroke.
G	G has two rounded stems connected at the base-line, and a curved upright stroke between them.	m	m has three stems connected at the top and disconnected at the foot-line.
S	S is another rounded letter, but the curved stroke within has a horizontal extension and does not connect.	w	w has three stems also, but the latter two are connected at the foot-line.
K	K has a curved hair-line projection at its top, and its two stems are connected in the middle.	r	r has no hair-stroke at the left side of the stem at its foot.
N	N has two stems connected at the head, but not at the foot.	x	x has a long hair-line on the left side of the stem at its foot, which the r has not.
R	R has its two stems connected in the middle.	v	v has its two stems connected at the top and at the foot.
M	M has stems that are connected at the head and not connected on the foot-line.	y	y has stems connected at the top only; its right stem projects below the foot.
W	W has stems that are connected on the foot-line as well as on the head.		

Although *ï* and *ÿ* are of the same form in capitals, the lower-case *ÿ* projects below the foot-line, as it does in English. The lower-case *ſ* is used at the beginning and in the middle of words, but the final *ſ* is always of short form.

*	§	†	‡		¶	☞									
		ä	ö	ü											
									—	-	—	—	.		!
									Ⓐ	Ⓑ	Ⓒ	Ⓓ	Ⓔ	Ⓕ	Ⓖ
									Ⓢ	Ⓩ	Ⓚ	Ⓛ	Ⓜ	Ⓝ	Ⓣ
									Ⓟ	Ⓠ	Ⓡ	Ⓢ	Ⓣ	Ⓤ	Ⓡ
]		Ⓝ	Ⓣ	Ⓡ	Ⓤ	?	!	,
fl	ff	fl	ff	fl	ff	fl	ff		Ⓝ	Ⓣ	Ⓡ	Ⓤ	?	!	,

German upper case as laid in the United States.

ä	ö	ü		¶	☞		1	2	3	4	5	6	7	8
i	b	ch	ck		e		i	,	ø	y	g		c	9
u													ft	0
ß	l	m	n		h		h	f	ff	w	,	□	□	
ä					□		□							
r	v	u	t		□		a	r			;	:		
q											.	,"		

German lower case as laid in the United States.

The thirteen double letters of German are :

ch	ch	ff	ff	fl	si	ft	st
ck	ck	fl	fl	ff	ss	ß	sz
ff	ff	ll	ll	ffi	ssi	tz	tz
fi	fi						

In the United States the ordinary upper and lower cases that are used for English are made to serve for the casing of German type. The scheme presented on the preceding page is that of the arrangement in many book-printing houses where German is used only for occasional words or quoted lines. In Germany the characters for a complete font are laid in one broad case of peculiar construction.¹

The accent most used is the umlaut over vowels ä, ö, and ü. German nouns, common as well as proper, take capitals for initial letters, but adjectives derived from proper nouns, as a rule, do not take the capital. The words *frankfurtisch*, *englisch*, *preussisch*, for *Frankfortish*, *English*, and *Prussian*, do not take capitals, but when such adjectives form part of compound proper names, as in *Schwarze Meer* (*Black Sea*), they do take a capital. *Frederick the Second* takes capitals in *Friedrich der Zweite*. The first personal pronoun, *ich*, begins with a small *i*, but the person addressed, *Sie*, or *you*, takes a capital.

Words are divided with the same irregularity that now prevails in English. The scholarly writer prefers to divide a word by its derivation; the ordinary writer, by its pronunciation. One practice is fixed: some double letters cannot be divided; the doubled consonant at the end of a line, as in *hei-ffen* or *Stü-ffe*, is always put over in the second line.

¹ For the plan of this case, see *Weber's Katechismus der Buchdruckerkunst*, p. 53, 16mo, Leipsic, 1901.

Hyphens are employed in great profusion for the compounding of words when these words are used as a long phrase or a qualifier.

The apostrophe is frequently used, especially in poetry, to indicate a suppressed vowel.

Quotation-marks in German are made at the beginning of the quotation with two comma-like marks that project below the line, and at its end by the same marks inverted, which are then at the top of the line. The apostrophe is never used for a quote-mark.

Arabic figures are as common in German as in English, but for emphasis the italic character is studiously avoided, yet is sometimes used as a mark of reference.

A B C D E F G H I J K L M N O P Q R
a b c d e f g h i j k l m n o p q r s t u v w x y

Fraktur.

A B C D E F G H I J K L M N O P Q
a b c d e f g h i j k l m n o p q r s t u v w

Schwabacher.

A B C D E F G H I J K L M N O P Q R S T U V
a b c d e f g h i j k l m n o p q r s t u v

German text.

These characters are strictly and almost exclusively German, but German type-founders make many other forms. The spurs and angles of black-letter favor the invention of eccentric variations, which have always been in favor with job-printers everywhere.¹ Flemish black-letter is occasionally used for display lines in some kinds of book-work.

A B C D E F G H I J K L M N O
a b c d e f g h i j k l m n o p q r s t u v w x

Old Flemish black used by Caxton.

x B C D E F G H I J K L M N O P Q R S T U V W X
a b c d e f g h i j k l m n o p q r s t u v w x y z ff fi fl ffä . . ;

Modern Flemish black.

The roman character, known in Germany as the Antiqua, is preferred for the printing of scientific books. The regular German letter, used in newspapers and for ordinary books, is known as Fraktur. The lower-case characters of the Fraktur are much compressed: the ordinary lower-case alphabet measures only about ten ems of its own body; roman lower-case of the same body by British and American standards measures thirteen ems. A broader and simpler form of German character is known as Schwabacher. This tendency to simplification is increasing; many of the faces recently produced by German founders for text types are

¹ See Chapter X of *Plain Printing Types*.

much more distinct than those in fashion during the last century.

A careful compositor who does not understand the German alphabet can fairly represent it in type when he has printed copy, but it is not wise for him to attempt to set type from German manuscript, for its script is unusually bewildering.

GERMAN SCRIPT

Aa Bb Cc Dd Ee Ff Gg

A a B b C c D d E e F f G g

Hh Ii Jj Kk Ll Mm Nn

H h I i J j K k L l M m N n

Oo Pp Qq Rr Ss Tt Uu

O o P p Q q R r S s T t U u

Vv Ww Xx Yy Zz

V v W w X x Y y Z z

Diphthongs

ä ö ü

æ œ ü

Joined letters

ch ss st sz

ch ss st sz



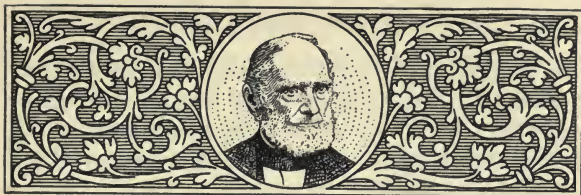

DAVID BRUCE, JR.

VII

MAKING UP

The running title . . . Signatures . . . Notes and illustrations



BEFORE the making up of type from galleys is attempted, the maker-up should have for his instruction a diagram of one page, which should be pen-drawn upon a regular section, properly folded, of the paper that will be used for printing the book. On the first leaf of this section should be outlined in exact position the length and width of the page to show the margins required; written directions should be added concerning signatures, types for running title, subheadings, the sinkage of chapter heads, the blank space above and below extracts, and all other details about which there may be uncertainty. This diagram should be approved by the author.

The first duty of the maker-up is to cut and notch a gauge of cherry reglet to the length of the page ordered. The gauge should be a full page of the regular text type only (without cuts, extracts, tables, or blank lines), upon which should be written the number of regular lines. The lines on every page should be in exact register with corresponding lines on the back of that page, but this nicety may not be attained if the proper marking of important divisions on the gauge has been neglected.



33 lines of type, including head- and foot-lines.

Gauge for making up pages.

In most printing-houses making up is done from the type that has been read and corrected on the galleys.¹ Before cutting the gauge for pages intended to be printed direct from type, ascertain the length of the furniture in stock that will be needed for the gutters of the back margins. Each page of type should be a little longer than the gutters, but when the gutters in stock are only a trifle longer, the foot-line should be set in a larger size

¹ A book or pamphlet ordered in great haste may have to be made up before its reading and correction, but this method is not to be recommended. If any compositor has made a very long out or doublet, or if the author

chooses to add new or to cancel old matter upon the proof of the made-up page, every page following in that chapter will have to be re-made up. This means an unnecessary waste of time and serious expense.

of quadrats that will make the page project a trifle beyond the gutter. This forethought may prevent the needless cutting of furniture.¹

The galleys of composed type that will be needed for the making up of a full form of letterpress should be assembled in front of or near to the maker-up before he begins his work. These galleys should be accompanied with the copy and proof, as well as the cuts, tables, maps, or any other irregularity that may be needed in the form. When there are no such irregularities to an even make-up as are produced by cuts and tables, the maker-up can approximately measure and mark off on the proof the proper length for each page before he begins to separate the composed matter, but he must regulate its division so that the last short line of a paragraph in a descriptive text shall not appear as the first line on a new page. In this position the short line is a blemish to be prevented. Poetry and short dialogue matter are unavoidable exceptions.

When it is required that a pamphlet of one or two sheets shall consist of or not exceed the prescribed number of pages, it may be necessary to shorten or lengthen the page. For this possible departure from written instructions on the folded pattern sheet, explanation must be made to and permission for change be had from the foreman. The space occupied by composition must be carefully computed, and the matter must be arranged

¹ See illustration on page 63.

and divided so that it can be kept within the limit. In matter on galley, leads or blanks can be added when it is necessary to drive out, or they can be withdrawn with facility when the matter has to be taken in; but if pages are made up unthinkingly, without some previous calculation of the space to be occupied, they will have to be made up anew.

The maker-up is measurably responsible for the justification of composition passed by him. If he finds that it has been slackly justified, or if type has been set up in an unworkmanlike manner, he should return the galley to the compositor in fault, and require him to amend it.

The maker-up should be in an alley where he has ready access to leads of different thickness, quadrats of different bodies, brass rules of graduated length, and to quotations, or electrotyping bearers, and all needed kinds of blanking-out materials. The running titles, foot-lines, and blanks that are required for one full form should be set before making up begins, and be placed on small galleys within easy reach. It wastes time to set them separately during the process of making up.

A quarto galley of brass with a low rim should be preferred for making up and tying up the ordinary page. The page cord, which should be thin, strong, and long enough to surround the page four times, is first placed at the outer lower corner of the page, and is there tightly held by a finger of the left hand while it is successively stretched with

increasing tightness around the four corners. The free end of the cord is made secure by thrusting it between the tightened cord and the type with the nib of the composing-rule, in a loop at the place of its beginning, and drawing the loop tightly toward the near corner. The free end of this cord must be left exposed upon the face of the page, so that it can be easily seized and unwound by the stoneman when he has protected each page in the form with surrounding furniture.

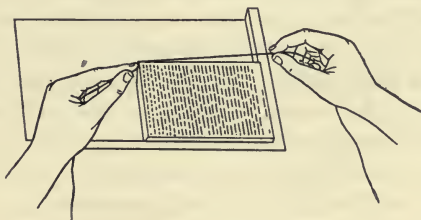

Quadrats with nicks at the ends of the foot-line should have the nicks turned inward to allow a free up-and-down movement of the page cord. The nib of the composing-rule can be used to push the cord up and down at diagonally opposed corners to increase the tightness of the cord and give it a broader bearing against the centre.

Each lift of type put upon the make-up galley should be pressed upward and compacted sidewise to make the composition square and solid. If this is not done, the type may be tilted slightly or made

up "off its feet." This fault is hard to rectify on stone or press. The page of type off its feet is sure to make a faulty electrotype plate.

The copy and the proof should be continually before the maker-up, who must see that the beginning of each paragraph in type tallies with the same paragraph in copy. To neglect this precaution is to hazard the risk of an omitted or a transposed paragraph.

Making up includes much more than the division of matter in pages of uniform length. The maker-up is required to set the running titles, with their paging figures, blank lines, and foot-lines, to adjust the variable width of the blanks, properly to place notes, tables, extracts, illustrations, and finally to put the made-up pages in proper order upon the stone. In some printing-houses he is required also to set chapter headings and subheadings.

THE RUNNING TITLE

The pages known to bibliographers as recto and verso are respectively called by printers odd and even. The figures for odd pages, as 1, 3, 5, 7, etc., are set at the end of the line; the even pages, 2, 4, 6, 8, etc., are set at the beginning of the line. The white line that separates the running title from the text, as well as the foot-line at the end of the page, is often composed with quadrats of the type of the text, but when the running title has been

ordered in small capitals over a text of large type, the white line so made will be found too wide, and a narrower blank will be more approved. In some recent books of good workmanship two leads only are used in place of the white line.

The words and the type for the running title at the head of every page are usually determined by the author. When this running title is a summary of the contents of the page, which cannot be written before the page has been made up, it is customary to set up a quadrat line with paging figures only and to ask the author to write the running title on the proof of the made-up page.

Some books are ordered without paging figures in the running title. Paging is made with small figures in the foot-line, where they may be an annoyance to the gatherers of the folded sections by confusing the figures of the signature with those of the page. The thin figures that are cast upon the en body may not be sufficiently legible. When it can be done, distinctive figures should be selected, that cannot be confounded with the signatures.

— 16 —

(362)

-#468#

[17]

When there is no running title, the paging figures may be put in the centre of the head-line in the type of the text. It is not an improvement to inclose them in brackets or parentheses, or to add to the figures dashes or decoration of any kind.

Paging figures on a smaller or larger body than that of the text type may be justified in and made solid with the quadrat line below them by the use of a properly selected thin space. The large figure for paging is generally preferred. Quadrats are better for the blank line below the running title; two leads may be allowed, but three or more tend to make composition spongy.

Some pages need no running title. It is never placed over a chapter heading or over a full-width illustration that appears at the head of the page, but the paging figure that is needed should be put in the foot-line. In centring a running title, paging figures must be rated as blanks or quadrats.

In some books the selection of type for the running title is left to the maker-up, who should find variety enough in the different sizes and faces of roman and italic capitals or lower-case. Black-letter may be occasionally selected to advantage. Monotype and light-faced antiques are permitted in running titles that may receive undue wear, but ornamental types and pen-drawn lettering are never acceptable to the discreet publisher.

For dainty little books very small capitals were once in high favor, but when the word was short and over a page of type of a body three or four sizes larger, the running title in this style was feeble.

Thin spaces make the running title of small capitals a little clearer, but the figures for pages are usually too small, and the cross-rule underneath does not compensate for this feebleness. In the running title of many words, thin spacing of small capitals is impossible, and unspaced small capitals are not easily read, nor is the effectiveness of a running title in small capitals improved by selecting full capitals as initials for important words. Small capitals of pica are small enough for an octavo page.

The running title of one word only may be in capitals of the text or of one or two sizes larger.

64 VOLTAIRE

The spacing out of the letters of a short word until it fills the measure is one of the many freaks of modern practice that have been found attractive in advertising pamphlets, but it is not commendable in the running title of any library book.

V O L T A I R E

Running titles that indicate the subject-matter of each page are most acceptable in the lower-case italic of the text. Capital letters may be used in a running title of lower-case for its first letter and for strictly proper names, but not as emphasis for important words. Italic larger than the text may be used with advantage on a large page, but an italic of smaller body than the text type is never pleasing.

64 THE INVENTION OF WRITING

A running title with more words than can be crowded in one line must be divided to appear on two facing pages. When the chapter ends upon an even page, a condensation of the title matter should be supplied by the author.

462 HISTORY OF ENGLAND CH. XV

Standard histories often have their running titles in full capitals on a body two sizes smaller than that of the text. Specifications of chapter or of date are sometimes added.

176 ZEAL AND IMPRUDENCE CH. XXIII

In other histories the mention of the chapter, book, or canto is made a shoulder-note to line with the first line of text, but this is done to best advantage on pages that have side-notes.

66 A SENTIMENTAL JOURNEY

When the text type is leaded, the running title may be thin-spaced with good effect, but avoid em quadrats.

78 *BABYLONIAN LEGEND*

Italic capitals are not a wise choice, for some of their types are kerned and liable to break, and some letters do not neatly mate with other letters. They often show gaps and unequal inclinations that are unsightly.

86 *MOLINOS THE QUIETIST*

Another novelty in running titles is the placing of the words close up to the back margin of each page.

EGYPTIAN HIEROGLYPHICS 65

The division of over-long matter for the running title should not mangle phrases. Closely related words should be kept together, even if one word only appears on one page. A long word should never be divided with a hyphen.

1689 WILLIAM AND MARY 463

Sometimes the specification of the number of the chapter, book, or canto in the running title, at the end of the line, is needlessly fenced off with brackets.

A.D. OF THE CHRISTIANS 177
362

If side-notes are used, the page figure should extend over them. If it can be done, keep the specification of chapter over the side-notes, but it is not an improvement to separate it from notes with a three-em brace or dash.

THROUGH FRANCE AND ITALY 67

A wide-spaced running title over a compactly set page of text makes an unpleasing contrast.

OF THE CREATION 79

In this illustration the unsightly gaps have been concealed to some extent by judicious spacing. A wider spacing is not recommended. It should never be forgotten that spaces between letters should compel wider spaces between words.

MOLINOS THE QUIETIST 87

This method of treating the running title may be used with black-letter.

832 *The MEMOIRS of Book VIII.*

This facsimile of the running title of a London book of the early eighteenth century fairly exhibits the taste of early printers in the selection of type and the use of rules.

I 8 MODERN PRINTING

Thick-faced rules, apparently first used by the Strawberry Hill Press, and afterward more boldly by the Lee Priory Press, have been recently revived. They seem an attempt on the part of the printer to compel attention to subject-matter that would otherwise pass unnoticed. It is the imitation in print of an obsolete school of elocution, in which the orator was taught to change his voice from whispers to shrieks, and to give the greatest emphasis to

74**Les Heures Gothiques**

Whoever selects brass rules as cross-lines for the running title must be prepared to meet unexpected difficulties in the making of electrotype plates and largely increased expense in the securing of uniform presswork.

242 **Q** *Sequel to the Confessions*

Black-letter in the running title should be always a face of true old style to make it acceptable to the bookish reader.

Chap. VI. PHILIP de COMINES. 833

In the displayed circular or advertisement, dashes are commendable, but they are of doubtful value in a serious book. The eye is wearied with their continued monotony.

The Correct STYLE 19

trivial words. The speaker compelled attention, but he soon tired his hearers. This attempt at display, entirely proper in a handbill, advertisement, or tradesman's circular, is not really needed in any book. It may attract, but it irritates. Black dashes ordered by the publisher must be inserted as directed, but the compositor will make a serious mistake if he inserts them without order. Italic, lower-case, and small capitals are here needlessly combined.

Heures de Simon Vostre 75

The modern amateur who prefers straight lines and plain types should not authorize in one line a mixing of capitals, small capitals, italic, and lower-case types that would not be tolerated in one line of descriptive matter in the text.

of an English Opium-Eater 243

Modern designs of black-letter, ornamented or with marked eccentricities, are forbidden by publishers of library books.

The space to be allowed for the sinkage of a chapter heading, as well as for the width of blanks above and below a table or a quoted extract in the text, is fairly indicated by the general direction to set solid or leaded. Blanks may be wide in leaded but should be narrow in solid matter.

162 Trimalchio's Dinner

Lower-case of roman has some favor as a proper selection for running titles. The size selected is usually larger than the type of the text. It is not improved by hair-spacing.

When great compactness is ordered, a new chapter may closely follow the end of the preceding chapter, as is practised in making up the Bible. If a foregoing chapter ends a few lines above the foot of the page, it will be necessary to make more lines in previous pages by overrunning, wider spacing, and driving over the last lines of paragraphs, or by a new re-making up that slightly increases the blanks between the chapters. These methods will bring the end of the faulty chapter to the foot of the page, yet they may make a new difficulty in the compactly set book of short chapters. To begin a new chapter flush with the first text line of the page does not make that page pleasing, but there are occasions when this treatment cannot be avoided. When this happens, it is customary to emphasize

the irregularity by putting one more blank line over the new chapter.¹

ARCHIV FÜR BUCHGEWERBE

A running title with black decorations on either side and with cross-rules above and below is thereby made insignificant. This treatment compels the paging figures to be put in the foot-line, but consistency requires that they should be obscured with side decoration of similar peculiarity. Decoration pleases more when it is lighter than letters.

When a new maker-up has to continue the unfinished work of a predecessor, he must carefully examine the proof and copy of the type already made up, and make sure that the work he is about to do is its proper continuation.

SIGNATURES

Bookbinders need signatures as guides to the orderly arrangement of the different sections of the

¹ To the inexperienced the making up of composed type in pages of uniform length seems simple work. It would be simple if the copy had words enough and no more, without head-band, synopsis, or initial, to fill neatly the first page of the chapter; if there were words enough to allow that chapter to end in the middle of an even page; if the last short line of a paragraph did not occasionally appear at the head of a new page; if the gauge that defines the length of

the page did not seem to require the division of a cut or a table. These are a few of the many annoyances that delay making up. They require the continual exercise of forethought and the adaptation of means to ends in many ways that cannot be provided for by any arbitrary rule. Some of these irregularities are too difficult for the maker-up; they have to be adjusted by the author, who often has to add new lines or cancel lines already set to make a sightly page.

book. Paging figures in the upper corner of the leaf are unhandily placed for the convenience of the gatherer, who needs the guide at the foot of the leaf, where the section is first seized. The sequence of guide-marks made by alphabetical letters, or by figures following in numerical order, is more quickly seen than the sequence of page figures that have to be compared with the pages of a preceding section.

American printers prefer arabic figures for signatures, for they can be protracted indefinitely for the largest book, but British printers prefer alphabetical letters, and add to them a new specifying figure when the letter has to be repeated. Following the usage of early printers, the letters J, V, and W are never selected for signatures.¹

The number of pages allowed for a section and its signature is governed largely by the thickness of the paper to be printed: for very thick paper, eight pages; for the ordinary thickness of book paper, sixteen pages. The double twelves of twenty-four pages can be used with safety only on very thin paper, and their insettings of eight pages (usually a cut-off, separately folded) take a star after each repeated signature. Sheets of four pages folio and of twelve pages are selected only when the form

¹ In many old books the signature of a section of sixteen pages was repeated on some of the following leaves. B was the proper signature for the first text page, B i for the third page, B ii for the fifth, B iii for the seventh, with intent to show to the folder the proper position of consecutive leaves. These additional signatures for the inner leaves of a section, inserted as helps to unpractised folders, are no longer used.

has to be printed upon a paper of peculiar quality, size, or shape. Publishers and bookbinders prefer sheets of eight or sixteen pages, for they permit neater folding and sewing. Too many pages in a section of very thick paper create wrinkles in the central folds, and too few pages in a section of thin paper make the back bunched with thread.

Every book of more than one sheet has a signature-mark in the foot-line of each completed section. If the section has an inset, cut off and separately folded and inserted, this cut-off inset should take the same figure as its outset, with the addition of a star, thus: outset 2, inset 2*. When the book makes two or more volumes, the number of the volume must be specified in the signature-line, as in Vol. II, 2. The numerals defining the volume should be in capitals,¹ so that they may not be confounded with the arabic figures of the signature.

When page figures and signatures cannot be used, and when the text lines are of uneven length, as in poetry, and blanks are of uneven height, as in forms of prefatory matter, all the customary guides for exact folding have been removed.

¹ One of the new fashions in book-making is the neglect of a signature-mark in the foot-line. Some authors order it in a separate line about an inch below the regulation foot-line; others omit it entirely, but this omission makes added expense and gives needless trouble to all the workmen from compositor to book-binder. It is admitted that the appearance of the page is not improved by the signature in the foot-line, but its entire omission is dangerous, especially so when paging figures also have been omitted. More than ordinary care will have to be given to the gathering of the signatures to prevent disorderly arrangement.

Numbered signatures	Folio of 4 pages	Quarto of 8 pages	Twelves of 12 pages	Octavo of 16 pages	Double twelves, 24 pages	Lettered signatures
1	1	1	1	1	1	A
2	5	8	13	17	25	B
3	9	17	25	33	49	C
4	13	25	37	49	73	D
5	17	33	49	65	97	E
6	21	41	61	81	121	F
7	25	49	73	97	145	G
8	29	57	85	113	169	H
9	33	65	97	129	193	I
10	37	73	109	145	217	K
11	41	81	121	161	241	L
12	45	89	133	177	265	M
13	49	97	145	193	289	N
14	53	105	157	209	313	O
15	57	113	169	225	337	P
16	61	121	181	241	361	Q
17	65	129	193	257	385	R
18	69	137	205	273	409	S
19	73	145	217	289	433	T
20	77	153	229	305	457	U
21	81	161	241	321	481	X
22	85	169	253	337	505	Y
23	89	177	265	353	529	Z
24	93	185	277	369	553	2 A
25	97	193	289	385	577	2 B
26	101	201	301	401	601	2 C
27	105	209	313	417	625	2 D
28	109	217	325	433	649	2 E
29	113	225	337	449	673	2 F
30	117	233	349	465	697	2 G
31	121	241	361	481	721	2 H
32	125	249	373	497	745	2 I

Table of signatures and folios

273

Numbered signatures	Folio of 4 pages	Quarto of 8 pages	Twelves of 12 pages	Octavo of 16 pages	Double twelves, 24 pages	Lettered signatures
33	129	257	385	513	769	2 K
34	133	265	397	529	793	2 L
35	137	273	409	545	817	2 M
36	141	281	421	561	841	2 N
37	145	289	433	577	865	2 O
38	149	297	445	593	889	2 P
39	153	305	457	609	913	2 Q.
40	157	313	469	625	937	2 R
41	161	321	481	641	961	2 S
42	165	329	493	657	985	2 T
43	169	337	505	673	1009	2 U
44	173	345	517	689	1033	2 X
45	177	353	529	705	1057	2 Y
46	181	361	541	721	1081	2 Z
47	185	369	553	737	1105	3 A
48	189	377	565	753	1129	3 B
49	193	385	577	769	1153	3 C
50	197	393	589	785	1177	3 D
51	201	401	601	801	1201	3 E
52	205	409	613	817	1225	3 F
53	209	417	625	834	1249	3 G
54	213	425	637	849	1273	3 H
55	217	433	649	865	1297	3 I
56	221	441	661	881	1321	3 K
57	225	449	673	897	1345	3 L
58	229	457	685	913	1369	3 M
59	233	465	697	929	1393	3 N
60	237	473	709	945	1417	3 O
61	241	481	721	961	1441	3 P
62	245	489	733	977	1465	3 Q
63	249	497	745	993	1489	3 R
64	253	505	757	1009	1513	3 S

New guides for exact folding can be produced by inserting in the centre of the gutters (as between pages 1-8 on the half-sheet of octavo, and in the head-bolts between pages 1-4 on the same sheet) a short bit of hair-line rule, which will definitely mark the places where the sheet should be creased for folding. The printed guides so made will be hidden in the book by sewing, or will be cut off at the head or front by trimming.¹

When the number of pages for a full form has been made up, the maker-up should plainly mark on the proof and on the copy before him the last word in the form. This mark is needed by the reader and by the maker-up who may follow him.

A table of signatures is of some service to the maker-up, but it must not be trusted unthinkingly. The book made up, for the greater part, in sections of sixteen pages may have here and there sections of more or less pages, so made by printing one section out of order, or by the use of a different kind of paper for maps or illustrations.

When the imposing-stone is free, the maker-up puts his made-up pages thereon in proper position for the stoneman. If the stone is not free, he puts them in a wrapper of stout waste paper, and stows them in piles as may be directed by the foreman.

A page of text is trim, square, and symmetrical when its first and last lines are of full width. The short line that ends a paragraph is tolerated at the

¹ See Scheme 19 on page 353.

foot of a page, but it is a blemish when it appears as the first text line of a new page. Even the beginning of a new paragraph, with its slight indention of one em, at the foot or the head of a page is rated as a fault by the critical. As the maker-up cannot add or cancel words or transpose lines, it is impossible to avoid these faults in some measures of poetry, in short dialogue matter, or in any kind of composition that has to be made up in haste. Yet this fault can be amended in some kinds of composition, when time is allowed, by the observance of the following methods.

To prevent a short line at the head of a page, these expedients are often adopted: (1) Take out a line from the space allowed for the chapter head, and re-make up all the following pages until the objectionable line falls at the foot of the page. This is a tedious method, and it may cause a similar bad break upon another page. (2) Pick out a paragraph in any preceding page that could be spaced thinner, so as to make it one line less, and thereby provide the room for a new line. (3) Reverse the process: overrun a previous paragraph with wide spacing that will make a new line, and so drive over the objectionable short line and make it the second line on a new page. (4) Make the page a line short or long; but the two pages that face each other should be treated in the same manner. (5) Ask the author to add or cancel a word in any paragraph that will prevent the short line.

In the strict reprint the last expedient is impossible. When it is clearly unavoidable, as it is in some forms of composition, as in an ode or in short dialogue matter, no attempt should be made at change, for the apparent fault carries with it its proper apology.

Another alleged fault in make-up is a divided word broken with a hyphen on the first or last line of a page or a paragraph. To try to correct this fault by thin or wide spacing will make a much greater fault. In many lines it is impossible to do so. It can be corrected wisely by the author only, who can add, cancel, or substitute words that will prevent the use of the hyphen, but there are few authors who will take this trouble.

NOTES AND ILLUSTRATIONS

Pages that must contain illustrations, long notes, or tables of irregular size present many difficulties. Author and reader prefer that these additions shall be on the same page as the explanatory text, or at least on a page facing it. When the page is small and the note is large, the note and the text interfere, and the maker-up is often puzzled to decide the problem of precedence. The last line of a regularly made-up page may contain the reference-mark for a long note, which cannot appear on that page, and must overrun on two or more pages. When obstacles like these are foreseen, it is the

custom to send to the author clean galley proofs, marked to show the limits of each page and the obstructiveness of the note or illustration. It is to be expected that the author will add new matter to close a gap, or cancel matter already set to prevent an unsightly break. He is expected to cut up the proofs and paste them in the order he prefers on the prepared paper within the prescribed lines. He may not be entirely successful, but he can give a clue to orderly treatment that will be helpful.

When the irregularities in the text are tables or notes of full width, the new arrangement desired can be made by the author; but when these irregularities are illustrations of small size and odd shape that compel an overrunning of type that must be led down the side, the author's calculations of the space to be occupied by the type are seldom correct. His order for a make-up of matter is unavoidably tentative and experimental. The maker-up is often obliged to make up the matter in a way differing from that of the author before it is finally approved.

Foot-notes are often more annoying than cuts or tables. They must begin at the foot of the page that contains in its text the mark of reference, but they may overrun two or three pages. They can be separated from the text by a white line, or by a short or long brass rule. The white line is to be preferred, for a hair-line rule of any length is objectionable because it is seldom properly electrotyped and printed with uniform thickness of face.

When the width will permit it, the general appearance of the page will be improved by setting the notes in half-measure without the dividing brass rule. Each note should begin with the repetition of the reference-mark in the text. The marks furnished with the font of type are ungainly, but the superior figures frequently used in their stead may be so small as to be objectionably indistinct.

Long notes that overrun one page and appear on more than two pages can be avoided by giving up the page that follows the reference entirely to the note, but this treatment should not be attempted without the permission of the author.

Foot-notes should follow one another in the order indicated by the references in the text. A third or fourth note following a very long first note, all referred to on one page, can seldom be inserted on that page. The first line of the first note must be kept on that page, but its overrun must be transferred to the foot of the next page, and this transferred matter should be placed over the regular notes for the succeeding page, and be separated from them by a thin white line. This unfortunate alternative is a clumsy procedure, but it can be avoided when the author rewrites or rearranges the text and notes so that they can be kept near one another.¹

In a page of two or more columns the notes of

¹ Prosper Marchand's *History of the Origin of Printing* (Paris, 1740) has in its first chapter one overrun note that appears at the foot of the six following pages, and that is further elucidated by thirty-four subnotes set in a different measure.

a column may be kept at its foot, but when there are many notes in the last column that interfere with the placing of a cut or table on the page, the notes may be put in the first column.

A side-note in the margin should begin opposite the first line of the paragraph referred to. When these notes are too many and too long, superior figures or letters have to be used to indicate the relation of text to note. When the margin will allow, the side-note should be at a visible distance from the text.

Side-notes are usually set in type three or four sizes smaller than that of the text. Four picas is a favorite width of measure for side-notes, but when notes are frequent and margins are wide, the measure may be five or more picas. A side-note should not be indented, nor should its letters be hair-spaced or its words wide-spaced to make full lines. Composition should be even at the beginning of every line, but may be irregular at its ending, both on the odd and the even pages.

Abbreviations are tolerated in side-notes that are not permissible in the text, but capitals should not be used to give distinction to the initials of important words that are not proper nouns.

The names of books, papers, and documents cited in the text often appear in side-notes in italic. This is not a wise selection, for italic letters have many kerns, and the kerns may break off in this exposed position.

Cut-in notes are placed at the extreme end of the first, second, or third line of the paragraph. When they begin on the first line they give an unnecessary raggedness to the outline of the page. The width and height of a cut-in note must vary with the fulness of the note, but the white space about each one should seem the same in all notes.

To arrest the eye, the cut-in notes of educational works are sometimes set in small sizes of antique or condensed title. The bolder face of these types produces the desired distinction, but a critic may say that the change spots the page unpleasantly. For general use the ordinary cut of roman lower-case of small body will prove most acceptable.

One of the features of a profusely annotated old book was the inclosing of its text with notes on the top and side as well as at the foot, but this can be done with satisfaction only when the copy has been very carefully prepared by the author.

The legend line or verbal description of a large illustration, often set by the maker-up, can be in many styles. An old method set the legend in small capitals of the text type (often too large for the words) in one or two lines. When small capitals of a smaller body were selected, the legend so treated became indistinct. When the legend line is followed by a more particular description, as in the numbers or letters that refer to anatomical illustrations, this minuter description may be arranged in columns and in a very small size of roman

lower-case. A very long legend of two or three lines of small capitals may be indented in half-diamond fashion. When it exceeds three lines hanging indentation is a better choice.

A more approved style for the legend line is plain roman lower-case of small size (about three sizes smaller than that of the text type), with capitals only for proper names and for the first letter of the line. To capitalize its apparently important words is to invite from author or publisher repeated changes of these capitals. Roman lower-case should be clear enough for the legend line without trying to aid that clearness by means of petty display of capital letters. It is largely to prevent capricious alteration in capitals that the printer prefers small capital letters for this descriptive line.

Italic lower-case, gothic, and thin-faced antique, in capitals or lower-case, are occasionally selected to give to the legend line increased distinction, but all types of display are of doubtful propriety in a library book. The significance of the illustration cannot be improved, but it can be damaged, with black or eccentric lettering. The reader who does not fully comprehend it with an unobtrusive legend line will not be aided by bold type.

Illustrations that fill an entire page seldom need to be described in bold types. In sumptuous books the legend of a full-page illustration is often printed on a separate leaf of transparent paper, to be attached facing the illustration, for there are many

engravers who protest against the insertion of any type-work below the cut.¹

Legend lines are usually centred, but when the illustration is of irregular shape, its legend may be placed in a lower corner within any vacancy that promises a proper relief of white space, and the plate may be slotted or mortised for its insertion. To prevent wear of type in this exposed position, the legend line in very small type is sometimes put over a cut that must appear at the end of a page.

Over a cut at the head of a page the customary running title of that page should be suppressed.

The blank space to be allowed above, below, or by the side of cuts or narrow tables must be governed by the general openness or closeness of the composition. For double-ledged type the blank should be not less than a great primer wide; for very open composition two or even three picas may be used; for solid composition about one pica. An illustration is damaged in appearance when it crowds the type of the text.²

When the cut is very small and compactness is

¹ Although illustrators protest against explanatory legends in type at the foot or head of a full-page cut as damaging to their work, they see no impropriety in affixing to the half-page illustrations of articles in magazines descriptive lines in letters of large size and uncouth form that belittle the cut as well as the types.

² These remarks do not apply

to composition in black-letter, ostensibly in the Morris style, which favors the jamming of type close to the initial and even against a broad engraved border; but this contraction of the relief of a needed white space should never be allowed in any composition of roman type that always needs much openness for its fair presentation.

desired, type may be overrun and arranged on one or both sides, but the setting of type in measures too narrow should be avoided, as in any blank less than eight em quadrats of the text type, in which uneven spacing cannot be prevented.

Illustrations of irregular shape should be blocked on metal bodies and notched by the automatic machine recently invented for this purpose; if blocked on wood and notched by the hand-saw and file, the wood may warp, the notches will be out of square, and the types inserted in them are liable to work off their feet.

One of the modern methods of make-up is the placing of very small cuts or illustrations entirely in the outer margin, where they will not obstruct the text.

When it is ordered that two or more illustrations shall project beyond the regular measure of the page in the margin of a letterpress form, all the pages of that form should be made up to the full width of the widest page. This can be done to best advantage on the make-up galley. A centring in exact position of pages of different width can never be done quickly, and rarely ever accurately, upon the stone.

If the pages are to be electrotyped, the blank spaces above and below an illustration or a table (and indeed all the blanks) should be filled with bearers to insure the making of a good mould.¹

¹ See pages 73 and 74 of this book.

Illustrations of irregular shape that require types to be rearranged about them necessarily compel the overrunning of the composition. This process is always more tedious than the original composition, for the lines so treated must differ in length and may have to be repeatedly changed to prevent bad division or uneven spacing. Before overrunning is attempted, all alterations desired in the text should be made on the galley proof. To add or cancel words after the type has been fitted to the illustration and made up in pages will cost more than the original composition. To preserve decent uniformity in spacing, it may be necessary, even after overrunning, to ask the author to change one word for another to make a line longer or shorter.

The position of illustrations on a page is a question of taste usually determined by the author, but there is a general agreement as to the propriety of the following rules:

A very small and narrow cut may be put in the centre of the measure, with the type rearranged on each side, but the type so rearranged should be treated as two distinct columns, to read down the page and not across the cut.

If the cut is wider and will not permit decent spacing on each side, put the cut at one end of the measure, so that the type will be on one side only.

Two or more cuts, not dependent on one another, appearing on the same page or on pages that face, should be kept far apart.

When it can be avoided, an illustration should be put on the page so that it will not back another illustration on the following page, for this backing of two cuts against each other increases the labor of presswork and may produce a "set-off" of black ink where it is not needed, to the damage of each illustration.

The cut that is not wide enough to fill the measure, but that is too wide to have type put on one side, may have its appearance improved by surrounding it with a rule border. A rule with face about one point thick is better than the hair-line rule, especially if it is intended for a red-ink line. Parallel or concentric rules, one for black and one for red ink, are finical niceties; it is difficult to print them on a large sheet in exact parallel.

Two illustrations of the same size that have been prepared as mates to face one another on opposing pages should be made up to face with exactness. Cuts that are not mates can be placed at the head or side or foot of the page, to avoid the appearance of monotonous uniformity.

When a cut of full width is put at the head of the page, the running title and the folio figures should be suppressed, and the folio of the page may be put in small figures in the foot-line.

When a table or cut of full broad measure must appear in a page of two or more columns, each column of type must be made up to read continuously from the head to the foot of the page, and

without regard to the separation made by the cut or table.

In poetry, lines that rime should not be put on separate pages. Quoted lines of poetry should not begin a page when it can be avoided.

When the gauge shows that the chapter will end with two or three lines only on the last page, and the maker-up has been ordered not to lengthen previous pages, he must ask the author to add more lines to give a decent fulness to that page; or he may ask him to cancel some lines on previous pages, so that the chapter will have a neater ending.¹

A long quotation in a foreign language with its translation in a parallel column should have the number of words for each column carefully counted. When the words are unequal in number, the columns should be made of unequal width, so that the two columns will end on or near the same parallel. If this treatment is not possible, the column that contains the excess matter may be put in broad measure after it passes the parallel. This is troublesome, but it will prevent the unsightly appearance of one column huddled by the side of its mate that has a long gap of unbalanced white space.

¹To an impatient author the time taken for making up the illustrated pages of a chapter often seems unreasonably long, but it is unavoidable, for illustrated pages can be made up by one person only, and he may have to undo repeatedly what

he has done. Yet forethought will prevent some wasted labor. The type, cuts, and notes for each page should be cut out of an extra proof and be arranged in page form on the pages of a dummy before the practical work of making up is attempted.

The full-page illustration that occupies the broad way of the page often has its legend or descriptive line near the gutter or back margin. It is expected that the reader will turn the book half-way around, from right to left for the odd page and vice versa for the even page. This arrangement must be varied when two facing cuts are intended to explain or supplement each other. They should face one way, so that they can be read from the same position.

The adjustment of blanks before and after extracts, cuts, and regular or irregular subdivisions of the text is another duty that calls for nice discretion. These blanks may be of irregular width, —the more important divisions separated by wide, and minor divisions by narrow blanks,—but the blanks assigned to each class should be of uniform width as far as is possible. It is difficult to maintain this appearance of uniformity when blanks have to be increased to drive out, or diminished to take in, an extract, subheading, or quotation that comes at the head of the page. In this as in other cases, the best help is to be had from the author, who should be asked to change words or lines that interfere with orderly arrangement.

When a large piece of matter, as in a long motto or quotation of importance, has to be set in a narrowed measure, the appearance of the composition will be improved if all the lines are made full, without indentation in first line and without break of white in last line. It will be necessary to overrun

the matter repeatedly in different measures before this can be done properly.

When a dash is used for a subdivision, to make that dash seem in the centre, one or more added leads must be put below the dash. The shoulder of the last lower-case text line must be reckoned in blanking-out as one lead or more.

Type for the pages of a book should not be made up while it is wet or even damp. The wood-blocking of electrotype illustrations, and even the wood furniture that meets wet type, will be swelled by contact with moisture.

The exact placing in an open page of one or more lines of type selected for red ink upon a page in two colors will be made easier by putting a clean proof, on thin paper, of the entire page face downward on the make-up galley. The maker-up can then see the proper position of the red-ink lines. If this color page is made up solid, and of the same length as the page of black, avoiding a too free use of leads that yield under pressure, the pressman will be aided in making register.

It is not practicable to give suggestions for every peculiarity that may present itself, for make-up is a study without end. The workmanship of well-printed books should be critically examined for a study of the best methods.



THOMAS MACKELLAR

VIII

STONE-WORK

Stones and chases . . . Adjusting margins . . . Locking up
Taking proofs . . . Corrections . . . Clearing away



ONE of the most conspicuous pieces in the composing-room is the imposing-stone, a thick, smooth slab of hard marble, bonded with an iron tire, or bedded on plaster in a frame of oak wood. It is used as a table for making up newspaper forms that have to be printed on flat-bed presses, for adjusting book margins, and for locking up and correcting previously made-up pages of books or jobs. The space unused below the stone is usually fitted up with drawers for the stowage of furniture, or with racks for chases. Stones can be had of supply houses in many sizes, from 18 × 23 inches to 38 × 96 inches.

290 *Imposing-stone and appurtenances*

The larger sizes, which are weighty and liable to be broken or gouged by shooting-sticks, have been supplanted in many houses by tables of iron, that are of truer surface and every way stronger. The best iron tables have the edge rabbeted to the thickness of the ordinary brass galley, so made to give to the galley a needed rest when pages on the slice galley are launched upon the surface of the iron.

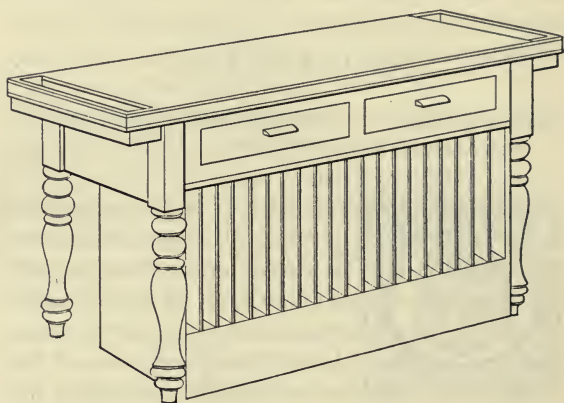

Imposing-stone with drawers and chase-rack.

The chase is a square iron frame in which composed type is locked up and kept secure, so that it can be lifted from the stone and carried to the press. It is made of cast- or wrought-iron, to suit the construction of a printing-machine or the shape of a form. The cast-iron chase is cheaper, but it is

relatively weak, and serviceable for small jobs only. Its greatest defect is incomplete squareness. The stereotype or electrotype chase, usually of cast-iron, is planed and squared to a true right angle on one of its inner corners. The cross × marked in one corner indicates the corner against which the head and one side of the page should be laid.

Wrought-iron chases are sometimes selected for large and light forms. When the chase is a plain iron frame without cross-bars or dovetailed slots for the bars, it is known as a skeleton chase. This serves fairly well for posters that have much wood type, for patent blocks and open forms, but it is not serviceable for any large form of great weight. Forms of four hundred pounds are not uncommon in newspaper work, but they have to be handled at great risk. When tightly locked up, the heavy form sags in the centre,¹ and the chase bends outward on one side, putting the form more or less out of square. When two very large pages have to be printed together (as is customary in the ordinary weekly newspaper), that are too heavy to be made properly

¹ It is difficult and sometimes impossible to lift from the stone large and heavy forms of type that have not been strengthened with cross-bars in the chase. In his *Hints on Imposition* (page 91), Williams recommends that "a smooth board which will extend fully across the form and chase may be nailed securely to the furniture near the centre of

the chase. The space at each end and between the board and the chase should be tightly filled up before lifting the form. The [face of the] type should be protected with soft paper." I have never tried this expedient, which seems good, but I should recommend screws instead of nails. One hundred and forty pounds is enough within a skeleton chase.

secure in one chase, twin chases are preferred. The twin chases give additional safety in handling, but the sides of these chases are often made thinner on the meeting side. For large pages of quarto form, twin chases are made with one cross-bar.

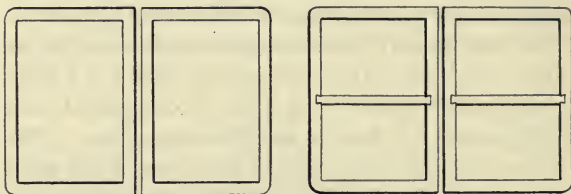

Twin chases.

Twin chases with one
cross-bar.

The cross-bar is sometimes welded in the frame, but it is oftener a movable bar of iron, cut with projecting dovetails on either end that accurately fit in slots of similar form cut in the chase. It is known as the short cross. So made, the tendency to bow outward on the side is prevented.

To prevent the bowing outward on the narrower ends, and to insure accurate register on book-work, it is necessary to use another bridge or connecting-rod, known as the long cross, which is firmly connected to the outer frame by the same device of slots and dovetails. As it has less resistance to overcome, the long cross is a narrower bar of iron. This variety of chase is known as the shifting-bar chase, or the book-chase. The side-sticks and

quoins are placed nearest the chase-frame, and the pressure on the pages of type, when properly locked up, is evenly resisted by the truly squared cross-bars. This illustration shows the position of the bars as they are used for ordinary forms of 8vo, 16mo, and 32mo. For forms of 12mo, 18mo, and 24mo, that require a folding of the sheet in three parts, the long cross (and sometimes the short cross) has to be put in another position, as is indicated by the places for slots in the illustration. To prevent

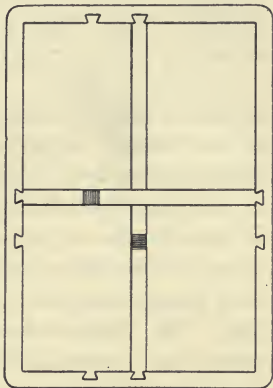

Book-chase with two shifting cross-bars.

the bars from twisting in the process of locking up, the pressure should be made equal from each one of the four sides toward the common centre. Once twisted, the shifting bars are made entirely straight or square with some difficulty.

The accuracy of a book-chase largely depends on the care given to the shifting bars, which are made to fit exactly, and should be removed and inserted with caution. As they cannot be transposed end for end alternately, nor be fairly fitted to other chases apparently of the same size, each bar should have an arbitrary number punched on one end with steel

punches, and this number should be repeated on the chase in the place where it meets the bar. Under no circumstances should the bar be put in any other place, for a chase is permanently injured when the bar is forced into a slot for which it was not originally fitted. Bars taken out of a chase should be dried, cleaned, oiled, and put away in a place where the edges of the dovetails will not be hacked or bruised. Carefully treated, they will do good service for more than a lifetime.

Screw-chases are sometimes provided for small presses. Two sides are pierced for screws which press against the stout iron bar that forces the type tight. The object sought is the locking up of a large form in a small chase, for which quoins and side-sticks cannot be used. The small screw-chase is not in favor; uneven pressure of the screw will twist the type off its feet, and the screws often rust and become immovable. Another form of screw-chase is made for locking up the forms of daily newspapers.

Long and narrow chases are supplied for headings

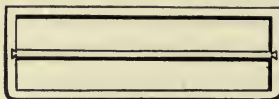

Heading-chase.

and bill-heads. They are sometimes used on the beds of printing-machines as a better substitute for many pieces of wood furniture, which

always has a tendency to bow or spring upward on the bed, often to the damage of the machinery.

The shooting-stick is a short bar of wood, iron, or brass that is used to wedge quoins in the process of locking up. The stick of hard wood wears out quickly, but it does not de-



Shooting-stick of iron.

face the stone, and for that reason it is preferred for all light forms. Brass or iron shooting-sticks are more efficient tools, and are really necessary for all heavy forms, but they require careful handling.

The mallet provided to strike the shooting-stick, usually of wood, is sometimes covered with sole-leather and sometimes fer-



Mallet.

ruled with an iron band. The planer is a stout cube of hard wood, which can be used with propriety for making level a form of type only before the form

is locked up. When used to level type after locking up, it may become a tool of damage.

The proof-planer is the ordinary planer covered with thick elastic felt. It is used for taking pounded proofs.

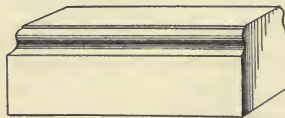

Planer.

Side-sticks, or bevels, are inclined planes of wood, iron, or type-metal, made to the height of low quadrats, to lock up or secure forms of type in chases that have been

properly wedged with quoins. Wood is cheapest and most used, but it necessarily receives hard treatment and is soon worn out. Its liability to warp is another objection. For newspaper forms and book-work the metal side-stick is preferred.

Quoins are the blunt wedges of maple, hickory, or boxwood that are forced against the side-stick by means of shooting-stick and mallet. Quoins and side-sticks of wood shrink after they have been wet and dried, and gradually relax their pressure; this sometimes causes a piling of the form. To prevent this accident, as well as to put a stronger pressure on the type, iron quoins, commonly known as patent quoins, have been invented. They are made in many styles, and some are protected by patents. The iron quoin most approved of is in two pieces, each having two small inclined planes of equal length, with cogs or teeth on the interior sides. A key-wrench, that grips the interior cogs

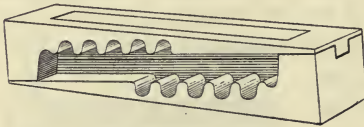

The Hempel quoin.

or teeth, expands the two pieces to a wider parallel and gradually tightens the type in the form.

A tongue on one half of the quoin, fitting in a corresponding groove in the other half, prevents either half from being twisted out of line. The power that can be exerted by this wrench is greater than that usually obtained

with the mallet and shooting-stick. These patent quoins are better than quoins of wood in preventing the slackening of pressure after the form has left the press, but they are not so efficient while the form is on press. The jarring made on some kinds of cylinder-presses tends to their gradual loosening.

A strip of thick blotting-paper or of thin pine reglet between a Hempel quoin and the chase may prevent the loosening of pressure produced by the continued vibration.

Another variety of iron quoin consists of two stout cubes of iron that can be pushed apart by working a ratchet against the nuts of a right and left screw fixed between the cubes.

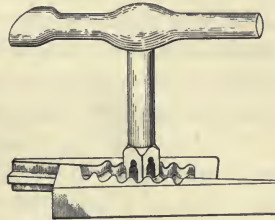

Hempel iron quoin with its turnkey.

ADJUSTING MARGINS

One of the duties of the stoneman is the making of margins. In some printing-houses it is the custom to have him determine all margins from scant verbal instruction without a plan. This custom is not to be commended, for it leaves too much to his discretion. As the margins on three sides of the proposed book may be unequally reduced by

trimming, and on one side by some methods of sewing or stitching, about which he is seldom fully advised, it seems proper that the determination of head and back margins for every page should be made in the counting-room by the person who has taken in the order for the book and has explicit instructions from its publisher about the margins.

For this purpose a pattern sheet should be made with carefully drawn pen lines that describe the width of back and head margins upon the leaves of any two mated pages of the paper that will be used in printing the book. These mated pages will be 1 and 8 in the half-sheet of 8vo, or 1 and 16 in the half-sheet of 16mo. The pen drawing should be made upon the outer leaves of a full section of the book, which consists of as many leaves as the binder folds together at one operation. It is usually eight leaves (sixteen pages) of ordinary paper, but it may be only four leaves (eight pages) of thick paper. If paper of the prescribed size is not in the house, a larger size may be selected, and a piece of this larger size must be cut down to the exact size of the paper needed for one section. The paper for this model should be folded with great accuracy to make even folds without waste. So folded, it will show the leaves as they will appear unsewed and untrimmed.

Before any attempt is made to draw the lines for the head and back margins, it should be known whether the intended book is to be sewed, centre-

stitched, or side-stitched, whether it is to be trimmed much or little, at head and tail only, or all around, or left with uncut edges. Fair allowance must be made in the pattern sheet for the paper that will be wasted in trimming, or taken up and concealed in the back by different methods of sewing or side-stitching, as may be more apparent in this diagram.

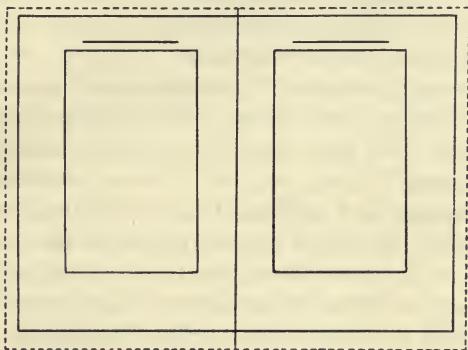

Outer dotted line indicates the full size of the untrimmed leaf; the black connected line near it, the leaf as it will appear after trimming; the outlined square in the centre of each leaf, the position of the page.

If the book is to be trimmed (or, even if untrimmed, it may afterward be rebound), begin by marking off at the head, front, and tail of the leaf the paper that will be wasted in trimming. For the head margin of an octavo allow for waste one eighth of an inch, for the front margin one quarter of an inch, and for the tail margin three eighths of an

inch. These are approximations ; a careful binder takes less, a reckless binder more. Then consult the binder as to the loss of paper taken up in the back by wire-stitching or sewing, and mark off the width of the paper so concealed. The paper taken up in the back by binding will be variable : in some kinds of sewed books it will be too small for allowance ; in the side-stitched book it will vary from one sixth to one quarter of an inch, or more if there are many sections in the book.

Having determined the dimensions of the leaf as it will appear after sewing and trimming, mark on the leaf, with clear pen lines, the size and shape of the page in exact position. Custom requires that the margins of a page shall be uneven : least at the back, but little more apparently at the head, much more at the front, and most of all at the tail. A page so placed on the leaf will be most acceptable to publisher and book-buyer. The proportions may be roughly expressed by these figures for the plain octavo : for visible back margin (after sewing) 4 to 5 picas, for head margin 5 to 6 picas, for front margin 7 to 8 picas, for tail margin 8 to 9 picas, it being understood that these will be the measurements of the leaf after sewing and trimming. The width of the paper lost by trimming or concealed by sewing must be estimated and allowed for in the proposed margin on the pattern sheet. These apportionments will be satisfactory for the ordinary book, but a publisher, for peculiar reasons, may

require margins to be wider or narrower. If so, they must be changed to meet his wishes, but the rule of a steadily increasing width of margin, beginning at the back, increasing at the front, and greatest at the tail, is seldom departed from in the ordinary well-made book.

The head and back margins should be first determined. If they have been considered with relation to their waste by trimming and sewing, they will be seldom changed. If correct on the pattern sheet for the two mated pages of a section, they will be correct for all the pages in the form, whether that form is an 8vo of one section or a 64mo of four sections.

Front and tail margins can be most accurately made by the stoneman, for they cannot be predetermined with precision by guesswork. The pages in a form should be so disposed on the stone that they will fairly fill the sheet, without any waste of paper, and yet present the needed inequality of margin about every page when the sheet has been printed. In other words, the form must be made up to fit the paper. It may have sixty-four pages, to be divided by the binder in four sections for separate folding. For the form of many pages more blank must be put in the places where the sections have to be cut, but under all conditions the blanks must be so adjusted that the front and tail margins in all sections will be exactly uniform. So adjusted, every section can be folded evenly,

without waste or protruding bolts or edges at the fore edge and tail.¹

The diagram on page 299 is useful as a guide to the maker-up, but it is not enough for the stoneman. It does not sufficiently indicate the proper margins between meeting fore edges or meeting tails in the form of many pages. The form of 12, 16, 24, or 32 pages needs a surer guide.

The front margins for the form of eight pages can be determined by taking two leaves of the pattern sheet previously described on page 299, and lapping them over any two mated pages so that the edges of the paper shall accurately meet similar sides of pages in different quarters of the chase, as is shown in the opposite diagram between pages 1 and 7. Give to the front margins all the blank not already covered by type or by the furniture of back margin. The tail margins will be regulated by the pressman.

For the half-sheet of 16mo use the same method for determining the front margins, which, in this instance, will be between pages 1 and 13. For the

¹One method of ascertaining proper front and tail margins for the 16mo begins with accurately folding a sheet of its own paper to a section of eight leaves, leaving unopened all its folds or bolts. Then place a page of its type upon the first leaf of that folded section, and pencil a line all around the page on that leaf. With a sharp penknife stab each line in two places at wide inter-

vals through the folded section. That done, unfold the paper: the distance between parallel stabs will show the width of the blanks needed for proper margins. This method, of some service to a novice in margin-making, has its disadvantages. The adjustment of margins by measuring pages from extreme points with the paper to be used is a more common method.

Adjusting margins for eight pages 303

tail margin take a quarter-sheet of the paper, which must overlap from the tail of page 3 to the tail of page 5, accurately meeting the extreme ends of full

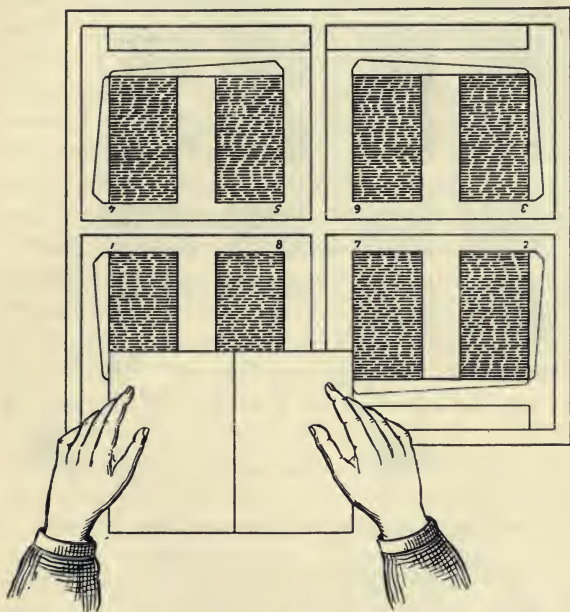

Making front margins for a form of eight pages.

pages, and all the surplus of blank must be given to tail margins on each side of the short cross-bar.

When the pages in other quarters of the chase have been margined in a similar manner, all margins will be correct. The sheet printed therefrom can

be folded correctly by print or by the edges of paper. Forms of more than 16 pages must be treated in the same way, for they are usually combinations on

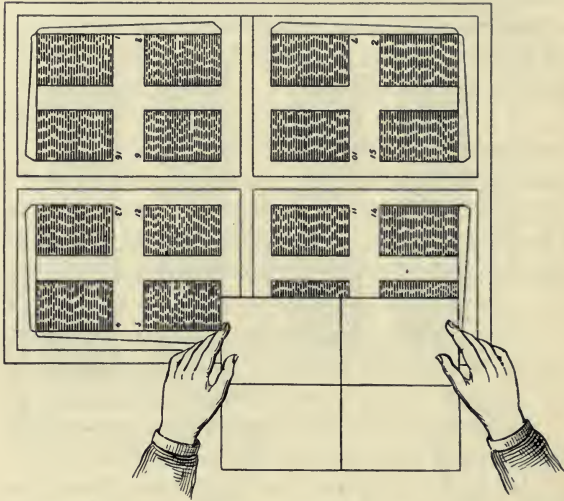

Making tail margins for a form of sixteen pages.

one sheet of different sections of 8 or 16 pages. Margins approved for one must be correct for all.¹

¹It may happen that all the sheets of the ream of paper to be used are not of the same size. The ream sold as of 20 × 30 inches may have some sheets that are one eighth or one sixth of an inch longer. Short sheets are rare. This slight excess in measurement, disregarded in ordinary

newspaper or job work, may be a real annoyance in bookbinding. When an over-long sheet has been properly folded, its excess on some leaves of one eighth or one sixth of an inch will project ragged leaves beyond the folded bolts, much to the annoyance of the reader.

In the book intended to be trimmed upon two or three sides, the leaves that are slightly over-wide or over-long may not be rated as faults, for the cutting machine that trims off the bolts also cuts off every other chance excess of paper and makes all the leaves of uniform size. But there are buyers who insist on uncut leaves of full size, with bolts unmarred by the knife. To them the protruding leaf is a serious blemish that must be removed. How to remove it neatly after printing is a puzzle. It can be "rough-cut" by tearing each sheet down against a sharp straight-edge, but never by the scissors or knife; by rasping off in the folded section the excess of paper with a rotary haggler; by grinding it off with a rotary circular knife. But all these methods call for needless labor, and none of them gives to the finished book the desired neatness. It is better to prevent than to correct.

If the ream of paper sold as 30 inches long and 20 inches wide contains occasional sheets that are $20\frac{1}{8}$ inches wide, take the largest sheet as the safer guide for making margin. Make the distance between pages 3 and 15 in the half-sheet of 16mo $10\frac{1}{2}$ inches instead of 10 inches. This means putting an added nonpareil reglet by the side of the long cross-bar. So treated, the excess of one sixth of an inch will be fairly divided in folding and apportioned to each half of the sheet. The sheets that are but 20 inches wide will have leaves that are one twelfth of an inch shorter than sheets with

bolts of folded leaves which must come flush up to the fore edge. In the form so made up there will be no ragged or protruding leaves. The deficiency in the short leaves will be almost imperceptible.

LOCKING UP

The locking up of pages in a form of type seems as simple work to the unpractised as the driving of wedges. This common belief is a serious error: pages cannot be truly squared and properly prepared for printing by brute force only. Locking up calls for unusual discretion in the selection of the quoins, chases, and side-sticks, as well as in the graduation of pressure.

Before made-up pages are laid down, the imposing-stone should be made perfectly clean. Particles of dust adhering to the stone will prevent an even planing down of the type, and the mould taken from types of uneven height will produce uneven electrotype plates.

Correct stone-work depends primarily on properly justified lines and exact make-up, but the stone is not the place to remedy the grosser faults made by the compositor. When faults have been discovered, or belated corrections in justification are required after imposition, the pages should be sent back to the galley. The readjustment of make-up on the stone is always difficult and is seldom done in a satisfactory manner.

The chase needs an examination. It may have on the cross-bars blotches of rust, or adhering cardboard put there by the pressman as a makeshift aid to exact register; it may be warped or twisted, so that it does not entirely rest flat upon the stone; it may be out of square, with bent or sprung cross-bars or bruised dovetails thrust in badly fitting slots. Chases with crooked or twisted bars often cause types to get "off their feet"; they work up spaces, and produce bad register.

The chase should be selected to fit the press upon which it will be printed, large enough to give free play to the quoins, but not so large as to compel the use of an excess of interior wood furniture. Its corners in the angles of the frame and in those of the bars should be tested with a steel square before it is accepted. If it is not truly square, exact register is made difficult and is often impossible.¹

A steel square and a long straight-edge of steel are needed for exact book-work by the stoneman as much as they are by a carpenter or a machinist.

¹A jobbing electrotyper of New York City, who received every day from different printers forms varying in dimensions from five to one hundred square inches, reports that many forms delivered to him were not truly squared and properly locked. The deviation from a true right angle was usually slight, not to be noticed in a print on one side only of the paper, but noticeable enough when many plates were printed together upon one sheet and the pages backed each other. In some of these forms, out-of-squareness was produced by locking up the form against the wrong corner, so that the pressure of the quoins had to be resisted by the unsquared inner angle of a cast-iron chase; in others, by too much pressure on one side and too little on another, or by worn and warped furniture of wood.

The pressman who has to print a letterpress form should not be required to correct the skewing of pages by inserting bits of cardboard between the chase and the furniture. A book form of many pages can be and should be prepared on the imposing-stone to produce perfect register.

A form of four or eight small pages may be truly locked up in an ordinary cast-iron chase, but the form of twelve or more pages of 12mo or of larger size needs a wrought-iron chase with true cross-bars. The chase without cross-bars, whether of wrought- or cast-iron, will bend outward in the centre, where pressure is great and resistance is small. Cross-bars are added to the chase as a means to maintain a uniform resistance on each side of the bars against the even, all-around pressure of locking up. If the pressure is unequal, and is greater in one half or one quarter of the chase, the cross-bars at the overtight part will bend. Slots are cut in the chase and dovetails are put in the bars to prevent this outward bending of type and to aid in giving squareness to the form.

A large form of one page only that contains a great mass of heavy type needs a chase with frame of extra thickness. While a tight locking up is needed to prevent the sagging of type in the centre of the form and to provide for its security in transit to the press, too strong pressure is sure to bend the chase and to bow outward the type in the form. To keep all lines of type square or in parallel, the

pressman may have to unlock the form after it has been placed on the bed of the press, to put a thin reglet between the chase and the centre clamp on the bed of a cylinder-press, and then relock the type in the form as well as relock the chase upon the bed. The stiff resistance of the centre clamp on the bed of the press is needed there to prevent the bowing outward of the chase and to preserve the straightness of the lines of type.

Furniture of wood that has been water-soaked and warped, frayed at the edges or rounded at the corners, should never be used. The outer furniture between the side-stick and the chase should be of one piece only, fully as long as the resisting side-stick or foot-stick. The fudging of two or more small pieces of wood as resists to the quoins, or the selection of two small quoins, compels needless labor and makes unsatisfactory work.

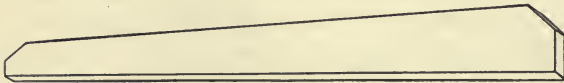

A side-stick properly cut.

Side-sticks of wood should be cut diagonally at the ends, so that they will present the longer side to the type, and not to the quoins. This will prevent the use of the side provided for quoins against the type, and will preserve the smooth side for the type only. The side-stick or foot-stick at its narrower end should be as long as but no longer than

the type it presses against: neither one should cross the other, nor should the head-bolt, gutter, or any other piece of furniture in the chase be so long that it will bind against the side- or foot-stick. The relative length and suitable position of each bit of furniture in a form of 8vo may be seen in the diagram on page 63. The accompanying diagram shows an improper selection of the side-stick. When one bevelled stick crosses another, the form is locked and unlocked with difficulty, and always at some risk of squabbling the type.

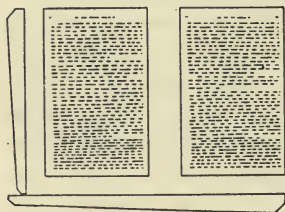

Improper side-sticks.

Metal furniture in one piece only should be preferred for the head-bolts as well as for backs or gutters. Side-sticks of iron, or even of type-metal, are better than those of wood.

Guttered furniture for back margins should be a little short of the full length of the page, and head-bolts a little narrower than the width of the measure, but if the head-bolts are cut too narrow the types near the corners of head-lines may be insecurely held. For ordinary work the furniture outside of the type and nearest the chase may be of wood, but metal is safer for interior work, for color-printing, for rule borders, or for any work that will require accurate register. When suitable garnishings have been selected and

adjusted, the quoins may be put in. They should be selected with care, for much wrong locking up is caused by the forcing of quoins into positions for which they are not fitted. Any quoin selected that does not rest flat on the stone and that will not move snugly against the side-stick should be rejected at once. It is bad practice to allow quoins to project at an angle so that they can be struck direct with the mallet, and not by the shooting-stick. The flat side of quoins should always rest upon the stone. When the side-stick is thin and has a slight bevel, it will be necessary, as increase of pressure may require, to change the quoins first selected for others of larger size. A thin side-stick will need more quoins than a thicker one.

As the cord that ties the page is gradually unwound, the quoins should be gradually tightened, by the pressure of the fingers, so that the side-stick will be kept close to the type and prevent the thin letters at the ends of the lines from hanging or dropping. At this stage the mallet should not be used; the pressure of the fingers is sufficient. The quoins should be equidistant, and no more force should be exerted than is needed for a gentle pressure.

When the page-cords have been removed, and the pages have been cautiously and securely pressed by side-sticks and quoins, the form may be planed down. Before this operation the face of the planer should be examined and brushed off. Some printers wrap its face with smooth clean paper. The planer

should be held firmly in the left hand, so that it cannot be moved sidewise by the blow of the mallet. It should always have a full bearing on the type, and never be allowed to hang over the side or over an open page that offers no resistance. It should be struck in the centre, not with the head but with the end of the handle of the mallet. In composition that has been fairly prepared, very little force is needed to press down the few types that may be too high, and taps with the end of the handle are enough for the purpose. When the planer is struck by the head of the mallet, it is usually struck at an angle, so that the force applied is unequally diffused; most of that force is exerted on the side of the planer nearest the striker, and the far-off side gets but little. When the blow is struck vertically by the handle, less force is needed, and that force is more equally diffused.

A violent planing down of the form is always damaging to the type, especially so when the striker works rapidly and makes his blows fall upon a planer which may be occasionally held at an angle that does not give it a full flat bearing on every part of the type. Violent planing down is wrongly supposed to hide some of the mischiefs produced by loose justification and over-tight locking up. In all forms that have been locked up too tightly, the type will bow or curve upward slightly about the centre of the form, and will not rest fairly upon the stone. The form that is so locked up may be

repeatedly planed down until the types meet the stone in the centre, but they will spring back again in this or in another quarter, and will soon carry upward with them the spaces that blacken the sheet.

The slightness of the pressure needed to secure a properly justified form is fairly illustrated by patent iron quoins. Slight twists of the wrench on the quoins will tighten the type more securely than many uneven blows with the mallet.

Bottled types are not so common now as they were, but when they seem to be the cause of the bowing upward of type in any part of the form, a rough remedy may be devised by inserting a strip about half an inch high of thin, bevelled cardboard between the side-stick and the lower part of the body of the type. The increasing thickness of the cardboard near the lower part of the body of the type, where the bottling is apparent, provides a more even resistance to the pressure of the quoins. It makes less the greater pressure at the base that tends to thrust types upward. When the bottling is conspicuous, the bevelled cardboard should be used on the opposite end of the page.

Types are about eleven twelfths and side-sticks about five eighths of an inch high. The pressure of locking up is consequently greatest at the foot of composed type, but if the type is in any way bottled, the pressure there will be unduly increased. The bevelled cardboard at the side will be an aid to more even pressure.

314 *Equality of pressure of importance*

In this diagram the outer black line represents the outline of a page before locking ; the inner dotted line, the same page after locking up. The distance

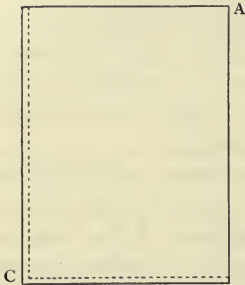

between these lines indicates approximately the "give" or compressibility of the type, which, in a long page of leaded type, is usually greater from the head to the foot than from side to side. The single types in the corner A are but slightly moved by locking up, but those in

the corner C will be moved much more, and in a diagonal line toward that corner A. To lock up properly, the pressure applied to the type must be gradual and even on each side. When the pressure is not even and gradual, one page or one quarter will hang or crook. If the quoins at the foot of the form are made full tight before any pressure is put on the side, the types will give in that direction only. If the types have been made needlessly tight by too much pressure at the foot, twice as much force must be exerted to move them in the contrary direction. Under this unnecessary pressure, the types will bow upward or hang in one quarter, the cross-bars may be twisted, or the chase may be strained or cracked. In every form too tightly locked up the types are sure to bow upward ;

then follows a violent and needless planing down in a vain effort to keep them on their feet.¹

The tightening of quoins should begin at the tail of pages by pushing up the quoins with the thumb. The pages should be next tightened on the side in the same manner. Each quarter should be separately treated. When the quoins cannot be moved by the fingers, the shooting-stick and the mallet may be used for this purpose. The first strokes of the mallet should be light, and should be given in regular order to the quoins in each quarter of the chase. For a large and heavy form of many pages to be locked up against cross-bars, it may be necessary to go around the form two or three times, gradually increasing the pressure. The stoneman should try to lock up type continuously and slowly; to do it hurriedly or recklessly is to do it badly. When the form is supposed to be tight enough, it should be tested by straight-edge and square, which will show where there may be too much pressure. In any form that has been truly justified and evenly locked, the pressure required will not be great.

The difficulty of locking up is always greater in forms that contain tables with brass rules crossing at right angles or with brass borders. Forms full

¹ Careful pressmen often find it of importance to slacken the quoins of a too tightly locked form as soon as it is laid on the bed of the press, so as to allow the types curved upward in the centre to rest on their feet. If

this precaution is neglected, if the presswork begins before the types in the form rest on their feet, an even impression cannot be had. Types will receive injury, spaces will work up, and the work will be delayed.

of thin leads, or that have columns of types set to different measures and at right angles, with cross-justification, or that are comparatively solid and incompressible on one side and open and spongy on the other side, are always troublesome. In forms like these the fault begins with careless justification, but is sometimes increased by badly cut and crooked brass rules that have not had the bur removed from the cut edges. Bent leads and foul or badly washed types are other hindrances.

If a form has one solid and one spongy side, as may happen in the ordinary form of bank-checks, a line of properly matched quadrats or quotations should be put on each side of the form as a guard. The side-sticks will then have an even and solid bearing against the guards so provided, and will not bend the types at one end or in the centre.

When mitred brass rules do not join, the accuracy of the mitring should be tested. Even when the mitring is exact, there will be difficulty if the rule is too thin, or if the form is locked with wood quoins and a thin wood side-stick. A large form of pages with mitred brass-rule borders can be truly locked up only by making use of an accurate chase, metal furniture for all divisions inside of the type-work, perfect justification, iron side-sticks, and patent quoins. To these must be added extra care on the part of the stoneman.

The art of locking up may be summarized in a few words: Justify and make up accurately with

types squarely on their feet. Use strong and true chases. Prefer metal furniture for all interior work. Make composition solid, and avoid a too free use of leads. Use iron side-sticks and patent quoins. Lock up slowly, gradually, and not too tightly.

Locking up is done for newspaper-printing machines by means of a wrench applied to screws in the chase. The pressure so exerted is great, and may make the types half a point higher. I have seen types humped upon the back of each body in places where this body opposed the nick of the types in a preceding line that relieved this pressure.

When the form has been finally locked up, the planer may be gently used, not to beat down a few types that are supposed to be over-high, but to ascertain whether the types rest truly on their feet and do not bow or curve upward. A solid sound, that will be readily recognized in the shock of a firm resistance, is always produced when types are on their feet, and the form that gives this sound and touch seldom needs any more planing down. The hollow sound produced by the planer over any portion of the form is evidence that the type has sprung upward from over-tight locking up. When this hollow sound is heard, it will be useless to try to put types on their feet by more planing down, for the bowing upward will reappear in another quarter. The only remedy is to slacken the quoins: if this makes the form insecure, faults in justification or make-up should be searched for.

Forms of type surrounded by furniture of wood that may be kept in the chase for many days will require a frequent retightening of the quoins. If this precaution is neglected, the gradual shrinking of the wood may cause the form to fall in pi.

Patent quoins of iron, firm as they may seem in their hold on type when the form is laid on the press-bed, sometimes work slack or loose by the constant jarring of the printing-machine. A careful pressman tests their tightness repeatedly.

Pages intended to be electrotyped are usually imposed in small chases of cast-iron, truly squared, but large enough to hold four or more pages of ordinary 12mo. Small types and half-tone photo-engravings need more pressure than large types. The large 4to or 8vo, or any page that contains a large illustration, is most satisfactorily moulded in the chase of one page only. A page of type and a full-page illustration should not be moulded together when they can be moulded separately, for each page requires different pressure.

To prevent the spreading of the wax over the sides and ends of pages, guards are provided by electrotypers. These guards are rudely cast slugs of type-metal, type-high on one side and of variable width and length, cut to suit the size of page required. When two pages are imposed in one chase, the form of guard is changed so that the plates made therefrom can be separated with ease. It is possible to mould type without any bearer or

guard, but the plate so made will be imperfect. When proper guards have not been attached by the stoneman, the electrotyper tries to lessen this de-

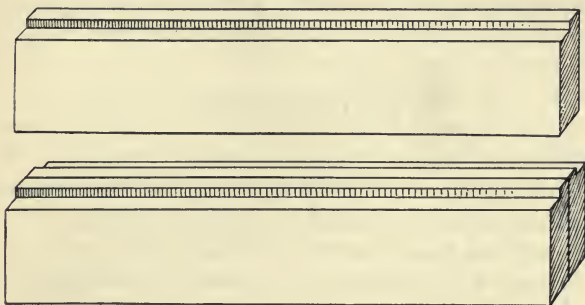

Guards for electrotype work.

fect with hasty indentations in the wax, but they never do the perfect work of guards or bearers.

The guards of metal furniture provided by the electrotyper to surround every page are intended to confine the moulding wax so that it will not spread outward, and to assist in forming the needed bevel that is afterward planed on the side of the finished plate. The best electrotype plates are made from types set up with high spaces and quadrats that are of even height with the shoulders of the types, and that prevent too much of a downward escape of the moulding wax. A further safeguard is provided against imperfect moulding by inserting in every open space on the page type-high bearers or resists to pressure, as shown on pages 73

and 74. These bearers are routed off the plate when they have served this purpose. The page so formed with bearers will lighten the work of the electrotyper and materially aid him in producing a printable plate.

TAKING PROOFS

Pages to be electrotyped should be proved on a hand-press; one with a bed-plate of 13 × 16 inches will be strong enough for two pages of large 8vo. Proofs on press, that do not damage the type, are preferred by readers to those taken by the proof-planer.

Letterpress forms, too large for the small proof-press, have to be proved by beating with the proof-planer after this manner: A sheet of sized paper, dampened on a clean stone by sponging it evenly on one side, is carefully laid upon the previously inked form of type. Then the stoneman takes the proof-planer in his left hand and lays it down squarely but quickly upon the inked form. Beginning at the nearest corner, with the end of the handle (not with mallet head) he strikes a quick blow usually in the centre of the planer. From that page he moves the planer to other pages, renewing the striking until he sees the print of the types faintly indenting the moist sheet. In like manner he beats all the pages, taking care not to slip the planer or to wrinkle the sheet, or to beat

too violently on blank pages or exposed lines to their injury.

Proofs of large forms are sometimes taken by beating the sheet with a stiff brush. Beaten proofs are wearing to the type, but the brush wears more and does not give so fair a print. The blanket on a proof-planer needs frequent renewal, for it becomes hard and inelastic after continued usage. The sheet so proved, when dry enough to handle, should be carefully folded by the print, so as to show uniform margins on each page. The surplus of paper, if any, at the ends should be torn off with a straight-edge, but the bolts that close the paper at head and fore edge should not be opened.

The reader or foreman who first examines the proof unfolds the sheet and tests it for correctness of margins. This he cannot do if the bolts have been opened. With the folded proof should also go to the reader's desk all the copy for that sheet laid in regular order. The stoneman, or the boy that helps him, then cleans the type with a brush moistened with benzine, and afterward sops out with a wet sponge the undissolved residuum that clings to the shoulders and counters of the type.

This duty of the stoneman is often half done. It is a mistake to think that proved types have been fairly cleansed when ink has been wiped off their faces with benzine. The type is not clean even if the face shows fairly white. The dirt of half-dissolved ink, and the gummy matter always left after

benzine has been swept from the face, gradually fill up the counters of all the letters. Type that has been treated so repeatedly will show raggedness and dirtiness about all its lines, and the shallower counters of letters like a, e, s will fill up. The electrotyper will be censured for faulty plates, and the pressman for his muddy and overinked presswork, when the fault has been created by the stoneman's neglect to keep the types perfectly clean. Type often is condemned as worn out when it is only filled up with accretions of hardened dirt.

Types so neglected that have received a bath of boiling lye (which softens the dirt so that it can be brushed out) and a thorough rinsing with water will be restored to usefulness. Benzine is a useful detergent, but it does not supplant lye. Caustic potash, shaved or in powder, slowly dissolved in alcohol, is an excellent cleanser of choked-up photo-engravings.¹

¹Neglect to clean type and wash forms began with the more extended use of engravings on wood. Engravers forbade the use of water that swelled and of lye that softened the wood. Alcohol and a weak solution of ammonia were the only cleansers allowed. This treatment made difficult the proper cleaning of the type near the engravings. The photo-engraver of half-tones, fearful of the fragility of his lines, advised that the surplus ink left upon an illustration be wiped off with soft flannel

moistened with oil. His purpose was served when the ink was rubbed off the face, but not removed from the form. He could not foresee that the residuum left would in time damage type as well as cuts. Instructions like these have indirectly taught compositors to sacrifice the durability of types for an immediate benefit to the cuts. No cleanser can be a perfect substitute for alkaline water. The form of type intended for the foundry or for press should be drenched with water.

The paper selected for the proof should be thin, smooth, well-sized, and evenly dampened. Proofs taken on dry paper are not so satisfactory to the proof-reader. The roller should be kept clean and tacky, and evenly coated with a film of good ink that has been protected from dust. Little ink, but much rolling, is required; a proof that is a trifle pale in color is always helpful to the reader in his search for bruised type. An overinked or strongly indented proof prevents the finding of bad letters.

Proof is returned, when read, to the compositor, with his name marked in the margin at the beginning of each take, and he is required to correct it immediately, for it is a general rule that corrections take precedence over all other work.

The tools preferred for correction are the bodkin and the tweezers.¹ Some compositors use the point of a penknife and the nib of a steel composing-rule, but they are mean substitutes; yet all correcting-tools will be destructive unless they are carefully handled.

The correction of turned letters or substitutes of one letter for another of the same thickness can easily be made, but when the marked letter is of a

¹The bodkin and the tweezers most frequently used are too frail; they often slip and bruise adjacent letters. When a letter has to be withdrawn from the form, the straight, thin-nosed pliers preferred by jewellers are better tools. Two bodkins with sharp, curved points, put at opposite sides of the body, will enable the corrector to lift one type or an entire word in a vertical line. Types need not be seriously damaged in correction when they are pulled up squarely and are not pried out at an angle.

different thickness, or when one or more letters are to be added or withdrawn, the line in which these changes are needed should be taken out and put in the stick for correction. Justifying on the galley or on the stone should never be attempted.

Correction on the stone is always an unpleasant duty, but the work may be lightened by carrying corrections to the stone in a paper tray which contains an assortment of justifying spaces.

The composing-stick, shooting-stick, and mallet should never be laid upon the face of the form. Each compositor should remove rejected type as soon as he has finished correction, and should notify the compositor whose work follows to go on with his share of the work.

Outs and doublets are difficult of correction, for they require the overrunning of the paragraph in which they occur, and sometimes the re-making up and always the re-reading of the form. These errors are usually caused by the carelessness of the compositor, who does not read the matter in his stick before he puts it on the galley, but the penalty he has to suffer is severe. In many offices it is a rule that he must not only make his work correct, but he must pay for the added cost of the re-make-up and re-reading.¹

When corrections have been made, a new proof

¹ On hurried newspaper work the slow correction of an out or a doublet may be evaded, if the reader can supply words enough

to make the lines come out even, but this liberty can never be taken in a faithful reprint or in any text of importance.

is taken, which is called the first revise. The reader compares the first proof with its revise. If marked errors have not been corrected, or if corrections have been made in wrong places, or lines have been transposed, or spacing has been made uneven, these errors are marked on the revise and sent back to the compositor in fault. After they have been corrected a new proof is taken, which is intended to be and should be literally correct to copy. This proof, known as the first author's proof, is sent to the author with the copy, after it has been annotated with queries made by the proof-reader.

The author's proof often comes back marked with alterations from copy. As these alterations are not caused by the negligence of the compositor and have not been provided for in the price agreed upon for composition, the expense of making the changes becomes an additional charge to the author. The author's proof is corrected by a careful time-hand, who marks on the proof the time it has taken and the date, and signs it with his initials.

Preparatory work that can be done on the stone should be done there before the form is ordered to press. To allow the pressman, whose time is more valuable than that of the stoneman, to correct gross faults in margin, to alter the position of pages, or to insert the points that may be needed for register, is not far-seeing management.

Points for type forms should be inserted on the stone. They are not needed for trimmed paper,

as an expert feeder can make register by carefully laying the sheet up to the side-guides, but they are needed for hand-made papers of rough edges and of irregular size, and may be needed for machine-made papers that have been unevenly trimmed.¹

The common form of point is a short, round iron wire, pointed on one end and a little more than type-high, which is usually inserted in holes drilled in the centre of the cross-bar of the chase. Another kind of point has a screw base that allows it to be inserted anywhere in the wood furniture of the form.

When the first side of the paper has been printed, the points are withdrawn. The perforations made by them serve as guides to the feeder for the placing of each sheet upon the spring points attached to the feed-board. Properly used, the points insure exact register. Points should be placed in the form as may be directed by the pressman—about fifteen inches apart. For paper intended for a folding-machine, exact position is of utmost importance, and points must be made immovable by accidental disturbance. Exact register may be impossible if the marginal furniture is rearranged and the points are moved while on the bed of the press.

Forms to be printed on a cylinder-press should have the type at a fixed distance from the edge of

¹ When crookedly cut paper cannot be retrimmed, fair register may be had if the paper can be fed on its first side to the left guide, and on the second side to the right guide, so that the same edge will always be presented to the guide.

the chase-frame, on the gripper-edge of the chase. The distance will vary from two to three inches, according to the set of the cylinder. To allow the type to come within this distance is to expose it to the risk of being crushed by the iron grippers. The stoneman should have a gauge made by the pressman that accurately defines the distance.

The paper provided for a form should have at least half an inch of margin on all sides of the type. It is practicable to print type on the extreme end of one side only of the sheet—the side opposed to the grippers. The half-inch allowance is needed for the grippers that seize the sheet, as well as for the bands that keep the paper close to the cylinder.

CLEARING AWAY

An important duty of the stoneman is the clearing away of all dead matter. The form that has been electrotyped or printed and is ordered for distribution comes back to the stoneman or his helper to be broken up. The electrotyped form is unlocked on the stone, but its furniture and quoins are carefully removed and kept together in good order, so that they can be used again for other forms of the same size. Its type is put upon the standing galley reserved for distribution after it has been relieved of its head- and foot-lines and other blanks that may be needed for future use on the same work. The large form is usually laid upon the letter-board.

The letter-board, which is a movable board of wood, is intended to hold dead type after the chase has been removed. It is made to slide upon cleats under the frames of stones or stands. For posters containing much wood type and forms of patent blocks the letter-board is useful, but for forms of small type it is a mischievous device, for it gives no proper protection to composed type and invites the making of pi. Forms of small pages not intended for immediate distribution should be tied up as soon as they are put upon the letter-board. A better method would be to put all tied-up or standing jobs on the top of the table of a low case-rack, where they can be seen: the placing of dead type in dark corners or on an obscured letter-board delays new composition and promotes disorder.

Dead matter that will not be distributed soon should be prepared at once for papering and storage in the type-closet. This work begins by taking out lines of quadrats and capitals, and everything but the ordinary text type. Leads, lines of quadrats, capital letters, display letter, and unusual sorts of every kind in masses should be laid aside for immediate distribution by time-hands. After the rejects have been culled, the matter saved should be re-made up in paper packages, uniform as to either length or width, so that they can be neatly piled one over another in the type-closet, without danger of breaking. The paper wrapper should be plainly marked in ink with the proper name of the face

and the body of the type, not omitting the number of nicks. A package so made up and labelled need not be opened for a reëxamination. Display letter, quadrats, figures, and any sort in limited supply, should never be papered when there is room for them in the open cases. Materials for regular use should always be made accessible.

The old rule that required piece-compositors to clear away all the matter in the dead form, and to distribute large masses of strange types that were not immediately needed, is no longer enforced. It is now the custom to have dead matter that is overfull of italic, accents, display letter, small caps, etc., distributed by the time-hands. It is expected, however, that the piece-compositor will distribute type taken from the closet, and not be too punctilious in refusing the distribution of a moderate amount of unusual sorts. It is to the interest of all persons that these sorts should be returned at once to case, for it is but just that the compositor who has been provided, as is usual, with special sorts from the storage case should return them to that case.

The type-closet should have separate compartments of stout wood for each face and body of type that may be kept on storage or out of case, each compartment firmly braced and fitted to sustain heavy weight. A printed label should be affixed in proper place, specifying on each compartment with exactness the name, face, and body of the type, and the number of nicks.

330 *Places for chases and chase-racks*

The chase-rack is reserved for forms of type that await reading or distribution. It is often placed under the imposing-stone, as may be seen in the illustration on page 290. For electrotype chases of the same size, a chase-rack can be made by screwing to the floor and to the bottom of the imposing-table parallel rows of stout oak cleats about two inches broad. The chase nested to stand upright without other support will slide and be secure in the grooves made by the cleats. For all chases of irregular size it is necessary to attach the upper cleat to a frame that has diagonal divisions and inclined shelves or supports. Small chases can be arranged in two tiers. If space will allow, the chase-rack could be advantageously placed against a dead wall, if that dead wall receives a fair light. It is a mistake to put it in any dark place, where the forms must be examined with inconvenience and possible injury.

In some book-printing houses the different duties of the maker-up and the stoneman are made interchangeable so that they may be done by one person. In all houses the stoneman should be a compositor of experience and intelligence, who knows how to adapt means to ends, and is not content to work by rote and rule only. He should work in concord with every contributor to the book, from publisher to bookbinder, for he can help or hinder them in many ways.



JOEL MUNSELL

IX

IMPOSITION

Elementary principles . . . Schemes for various forms from two to one hundred and twenty-eight pages . . . Inset forms . . . Oblong pages . . . The leaflet . . . Small pamphlets . . . New method of collating . . . Folding-machines
Concluding remarks

ELEMENTARY PRINCIPLES



IMPOSITION is a puzzle to the novice. He does not see why pages apparently laid out of order on the stone fall in order on the printed and folded sheet. He may learn to impose by imitating the practice of an expert or by copying schemes from some printers' grammar, but knowledge so acquired has limited application. Large sizes and strange shapes of paper,

combinations of two or more sections for printing on one sheet, rotary printing-machines, and new forms of folding-machines compel the occasional devising of new schemes. It is better to begin with the study of customary methods of folding.

Begin with folding blank paper for three different sections of 8, 16, and 32 pages (without cutting open the folds or bolts), and by pencilling upon the leaves so produced the numbers of pages in proper order. The sheet so treated when unfolded will show the relative position of mated pages, and this will give insight into the rudiments of imposition.

The first lesson to be learned is that too many pages cannot be properly folded together in one section for correct book-work: 8 pages are enough for thick paper, and 16 pages for paper of ordinary thickness. Whoever tries to fold correctly by one operation 32 pages of paper in one section will find that the paper buckles at the head fold of inner leaves, and that they are thrust outward at an angle that makes the type-work seem crooked.¹

¹ The central double leaf (pages 15-18) is unavoidably thrust outward by the thickness of its preceding seven leaves. This leaf is held tight at the head by unstretchable paper where it has been creased for the head fold, but it is thrust outward at tail more than the thickness of the preceding leaves. When stitched and trimmed, the front margin on this inner leaf must be nar-

rower than that of the outer leaf. On a large page this difference in margin may be unnoticeable, but when paper is thick and the page is small it will be noticed. The inner leaves of the section must be crooked, narrower at the top than at the bottom. Making up the form in two sections of 16 pages will prevent the crookedness, but the margins of the interior 16 pages must be narrower.

Sheets of 24, 32, 48, 64, 96, and even of 128 pages can be, and often are, printed in one form, but for the sewed book they are never imposed to be consecutively folded together by one operation. The printed sheet of many pages is subdivided, and each section is separately folded.¹ The newer styles of folding-machines made for pamphlet-work can fold a form of two or more portions simultaneously and inset one within another, but each portion receives separate treatment. It should be understood at the outset that in book-work an imposition of many pages in one form is not for one consecutive folding; it is a combination of two or more portions to be separately folded and afterward united.

When the different sections of a book have been gathered, folded, sewed, and trimmed, each section is resolved into a combination of double leaves nested one within another and held together and to other sections by thread. The double leaf that permits the binding-thread to pass through the fold of each section in the creased centre of the back

¹ Sometimes, as in the 12mo, the section consists of two unequal parts, one of 8 and one of 4 pages, and each part is separately folded, so that the smaller can be inserted in the larger part. In cheap pamphlet-work a section of 32 pages may be made by insetting one subsection of 16 pages within another section of 16 pages, but these thick sections are not tolerated in book-work. The library book must be sewed

with thread, either by hand or by machine, and sections must not be too thick in the back. Even in the ordinary sewed section of 16 pages, to stop buckling on the inner fold, it is often necessary to slit the paper on the cross-fold at head before the last fold is made. This prevents wrinkling, but it does not entirely prevent an appearance of slight crookedness in the margins of the inner leaves.

margin is the most approved method of giving proper security to the binding. It may be assumed that in all schemes of book imposition (the half-sheet of 18mo excepted) each section must contain double leaves. The leaves are always in doubles, and the number of pages in approved schemes of imposition are always multiples of four.¹

The double leaves in each section show that they bear relation one to another. In the ordinary 8vo, pages 1-2 and pages 7-8 constitute the outer double leaf; in the 16mo, pages 1-2 and pages 15-16 constitute the outer double leaf. Schemes for laying pages differ greatly, but the relative position of the first two and the last two pages of a section is unalterable in any scheme. A closer study of the different schemes yet to be presented will show that these pages and other pages have relations to one another that cannot be disturbed by any variation in the scheme of imposition.

¹ The single leaf of two pages that may appear in the pamphlet of a half-sheet 18mo is pasted down on an adjacent leaf. This single leaf also has to be accepted for inserted maps or prints made by different processes of printing, but pasting or tipping on is always regarded as a misfortune to be avoided. To prevent the bad workmanship produced by pasting down the single leaf of a map or print, it is often printed separately on a wider paper, and a narrow lap is creased on its extra width, so that it can be

neatly fastened by the sewing-thread through the centre of the lap. Single leaves of two pages can be securely fastened to other sections by side-stitching with wire or thread through the back margins of all the sections. Side-stitching is a method of binding at present unavoidable in magazines of large edition or in pamphlets that have to be made in great haste, but it has serious defects: it reduces the width of the back margin, and prevents leaves from opening flat. It is never used for library books.

All schemes may be grouped in these four classes :

1 *Forms of 4, 8, 16, 32, 64, 96, and 128 pages.* The sheet of 16 pages is usually imposed to be folded together as one section, the sheet of 32 pages is often cut to make two sections, and that of 64 for four sections.

2 *Forms of 12 or 24 pages, and their multiples.* In forms of this class one third of the paper is cut off and folded separately as an inset to be nested in the two-third portion. In the form of 12mo the cut-off is on the narrow side; in the 24mo on the wide side of the sheet; but forms of duplicate twelves, as in 48 and 72, are seldom imposed for offcuts and insets: it is customary to impose them as sections of 16mo. Preference is always given to the 16mo section wherever its use is practicable.

3 *Forms of 18, 36, and 72 pages.* Sheets printed on forms of this class are usually cut in unequal sections taken respectively from the broad and the narrow end of the paper, and are separately folded by hand. The 18mo of one signature, never used in careful book-work, contains a single leaf that must be tipped on the section.

4 *Forms of 20 and 40 pages.* Printed sheets of these forms have one fifth of the paper cut off from one end of the sheet, and this one-fifth subsection of the sheet is separately folded for an inset.

The consecutive folding of a sheet, first through its narrower diameter and next at right angles with its previous fold, as is done in 8vo and 16mo

336 *Sheet and half-sheet misleading words*

forms, is the simplest method and produces the best work. Forms of the second class are more troublesome, but they have to be used when paper permitting the 16mo folds is not to be had, and when a press to take on 16 pages is not available. Forms of the third and fourth classes are rarely used, but are needed for pages or paper of unusual shape.

Schemes of imposition are also known as sheets or half-sheets.¹ The pages of the sheet are always imposed as two forms in two chases, and each form is separately printed. The side that contains the first and last pages of the section is the outer form; the side partly concealed by the folding-bolts is the inner form. The printed sheet made perfect by two forms is known as a sheet, and this method of doing presswork is known as sheetwise.

The pages of the half-sheet imposition are always imposed in one chase. The paper selected for it is consequently twice the bigness of the sheet printed from two forms, and its printing on the two sides of the paper from the same pages necessarily makes two copies to the sheet. It is called half-sheet because this larger sheet must be cut in halves before either half can be folded.

Sheetwise printing was unavoidable when sheets were of small size and presswork was done on small

¹ Sheet and half-sheet are misleading words: they should be sheet and double sheet. It is impracticable to ignore them, for they have been used too long, but I shall try to prevent any misunderstanding in description by specifying the number of pages to the form and the number of sections to the sheet.

hand-presses, but the cylinder machine, that prints 16 and 32 large octavo pages at one impression, has made the half-sheet method more common.¹

FORMS OF FOUR AND EIGHT PAGES

The four pages of the folio newspaper are usually put in two chases and are laid down in this order :



Outer form.

Inner form.

1 Four pages in two forms and two chases.

This scheme exemplifies rules that control imposition in every form, however large that form may be.

The first page is usually laid down on the stone at the left corner. As printing reverses position in print, the left-hand page of type in the form will be the right-hand page of print.

The last page of every section is always nearest to and is the mate of its first page.

All odd pages are imposed to read from back to front; even pages from front to back.

¹ Each method has advantages and disadvantages. Sheetwise presswork allows the printed ink of the first form to dry before the sheet is backed up on the other form, but it also allows wet paper to shrink, and gives more trouble in making register. Half-sheet presswork on short editions may not allow ink to dry thoroughly, but it gives to the pressman at the outset more control of register; it enables him to maintain more even color, and to make sure of full count before he lifts the form from press.

338 *Relations of pages one to another*

When the page figures in every two mated pages (those side by side and nearest to each other) are added, the result of this addition is one more than the total number ¹ of the pages in that section.

To print four pages by one impression, the pages must be put in one chase to be printed on paper of double size. The sheet so imposed is known as a half-sheet of 4to, because it produces, when the sheet has been printed on both sides, eight pages of print, or duplicates of the four pages in the shape of two half-sheets. After the paper has been printed on one side, the pressman turns the sheet upside down and "end for end," which operation puts the edge A in the position before occupied by edge B, and vice versa. This makes him print page 1 upon the back of page 2,

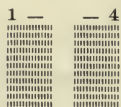
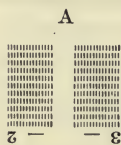

B

2 Four pages in one chase.

¹ The operation of this rule may be seen more clearly in the separation of a section of several pages: Take an ordinary quarter quire of six double leaves and page them consecutively as if they were the cut leaves of a sheet of 24mo. Then separate the double leaves and add together the paging figures of the mated pages:

- | | | | |
|------|------|------|-------|
| 1—24 | 4—21 | 7—18 | 10—15 |
| 2—23 | 5—20 | 8—17 | 11—14 |
| 3—22 | 6—19 | 9—16 | 12—13 |

The result of each addition will be 25, one more than the total number of pages in the section. The relative position of the mated pages cannot be changed in any scheme of imposition; they are mates and always must be mates. An understanding of this rule will often prevent the novice from laying down a page in a wrong position. If in the half-sheet of 24mo he has laid down 15 or 17 by the side of 9, he will know by mental calculation that the page is wrongly placed.

and page 4 upon the back of page 3. Paper so treated is said to be "turned on the short cross," or the short cross-bar of the chase. When printed on the second side, the sheet is cut in two, and each half-sheet is the duplicate of the other half.

This half-sheet of quarto can also be printed in one form from a long and narrow strip of paper by imposing the pages in this manner :

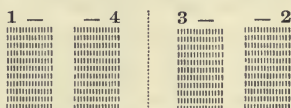

3 Four pages in one chase, long way.

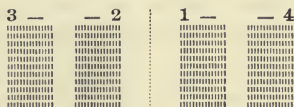

4 Four pages in one chase, imposed from the centre.¹

To impose with propriety any form that has to be made perfect upon pages in the same chase, it should be known at the outset whether the sheet will be perfected by turning it on the short cross or the long cross. The turn on the short cross is

¹ Scheme 4 is not so generally acceptable as Scheme 3, but it may be used with advantage when the inner pages 1 and 2 are open and the outer pages 3 and 4 are solid. As ink tends to collect at the ends of the inking rollers, and as excess of ink on open pages is a trouble to the pressman, it is sometimes of advantage to put solid pages at the ends of the form.

always preferred, for it allows the pressman to keep the same edge of the sheet to the feed-guides.¹

Before any scheme of imposition is determined for a large form, the thickness of the paper should be known. If there are too few pages to a section, there will be too many sections in the book, the cost of sewing will be largely increased, and the book will be made bunched at the back by excess of thread. If too many pages are put in a section, the sheet will buckle or wrinkle at the head of the innermost fold; all leaves will open stiffly, showing the sewing-thread; and the inner leaves will protrude unequally and have margins askew.²

Scheme 5, on the next page, shows that this form of 64 pages, when backed on itself, has to be cut in eight sections to make four duplicates of 16 pages.

¹ The turning of the sheet on the long cross, sometimes unavoidable, is unwillingly accepted by the pressman, for it compels him to present another edge of the paper to the feed-guides when he prints the second side. A new feeding-edge may compel him to register by points, a much slower process.

² Books or pamphlets to be distributed gratuitously, and that must be made at the smallest cost, like almanacs, trade catalogues, and advertisements of patent medicines, are often made up in thick sections to save expense in sewing. Sections of 32 and 48 pages are not uncommon, but their folding, sewing, and

trimming are never so neat as those of sections of 8 and 16. Thick sections are never to be seen in the books made for the library by reputable publishers.

Although sections of 16 pages are more used than any other, these sections are not always printed on separate sheets. A section of 16 pages may be a part of a form of 48, 64, or 96 pages. Even in the thick pamphlets of 48 pages intended to be centrestitched in one section, the pages are, as a rule, laid so that the sheet will be cut in thirds, making three sections of 16. Each section is separately folded; the second is nested in the first, and the third in the second.

35 — 38
43 — 42
47 — 46
3 — 6
14 — 11
15 — 10
7 — 2

54 — 51
59 — 58
63 — 62
61 — 60
23 — 26
27 — 22
55 — 54
81 — 78

53 — 52
60 — 61
57 — 56
46 — 49
21 — 20
28 — 29
24 — 32
17 — 2

37 — 36
44 — 41
45 — 48
5 — 4
12 — 13
9 — 16
8 — 1

5 Sixty-four pages in one chase : four sections of 16 pages.

In ordinary forms of half-sheet presswork, page 2 is put in an opposite corner or in a contrary direction from page 1, so that the backing of the sheet will bring page 2 on the back of page 1; and the first folding of the sheet at a right angle will bring 3 opposite 2; and the last cross-fold will bring page 9 opposite 8. That done, all intermediate pages are in order. The even page will back an odd page when the sheet has been turned, and the following odd page will face the even page when another regular fold has been made. This repeated cross-folding of the sheet brings the innermost pages within the interior of the section, so that the last four leaves will be mates of the first four leaves. In every imposition, whether in the "usual way" or "from the centre," long fold or cross fold, the pages must occupy the same relative position one to another, however peculiar the scheme or however large the number of pages in the form.¹

¹ It is to be supposed that a diagram has been previously given to the maker-up to define the shape of the page and to specify the width of the margins about the pages. This diagram sheet should be prepared in the office or by the foreman before the pages are made up. To require the stoneman or the maker-up to cut furniture and determine margins will be found wasteful of time and productive of error. The furniture should be selected before the pages are laid. The only pieces that can-

not be accurately measured or specified on the diagram are the thin pieces nearest to the cross-bars, which will be of varying width to suit the variable thickness of the cross-bars. The headbolts and thin cross-bar pieces can be put in their places afterward. A sheet of the paper to be printed should also be furnished to the stoneman. The proper adjustment of margins by this sheet has been illustrated on pages 299, 303, and 304 of this book. Exactness in measurement by this sheet is of great importance.

In the ordinary imposition of 16mo, page 1 appears in print upon the first leaf of the first half of the sheet that has opened leaves on the front, and page 9 upon the first leaf of the other half of the sheet that is closed by the bolts of folded leaves. But the pages can be imposed to be folded in another way: page 1 can be placed on the leaf taken by page 9 in the usual scheme of imposition. When pages have been so placed and the sheet is folded in this reversed way, the first leaf of the bolted half is thereby made page 1. (See Scheme 18.) This method of reversing is called imposing from the centre.¹

When the pages have been truly laid on the stone, the furniture selected should be put next to the pages. It is to be supposed that the length and width of each piece have been previously determined, so that no piece will interfere with another, and that all will yield gently to the pressure of locking up.

The selection of the chase is next in order. Pages to be electrotyped are usually imposed in chases of cast-iron that hold two or four 8vo or three, six, or eight 12mo pages. These chases should have

¹ The odd page put down in an ordinary scheme of imposition of 16mo as 3, 5, 7, or 9 can be used to place the first page, if following pages are put in correspondingly reversed positions. Page 1 in the outer corner of the sheet is most acceptable to folders by hand, but the makers of a few of the newer folding-

machines have to put page 1 in some other position to enable them to make use of proper mechanical motions in the machine. It should be clearly understood that a changing of the position of page 1 to the place usually occupied by some other odd page will compel corresponding changes of position in every other page.

frames about one and a half inches wide and three quarters of an inch high, to enable the iron fairly to resist the great pressure put on the form by the moulding-press. The old cast-iron chase for plaster stereotype, with frame one inch wide and two thirds of an inch high, that still survives in some houses, is liable to crack under this pressure. If the chase is not square, the plate will not be square.¹

The form of four or eight small pages, made up for letterpress, may be imposed in a cast-iron chase, but cast-iron is not to be trusted for any large book form. When the form is locked up, the frame will bend outward in the middle on each side, putting pages out of line and making register difficult. For all forms containing many pages, and even for forms of few pages that call for exact register, the wrought-iron chase, with slotted and dovetailed cross-bars, should be selected to prevent the outward bending of the chase frame and to provide right-angled sides as resists to the pressure produced with side-sticks and quoins. The chase selected should be tested by a square on the interior angles made by cross-bars. If the dovetails do not fit snugly, or if the slots at the intersection of the bars are loose and wabby, these faults should

¹Trustworthy apparatus, the first condition of good printing, is needed now more than ever. When presswork was done from small forms upon small hand-presses, out-of-squareness in a page or a form often passed un-

noticed. Authors and publishers of to-day are much more critical. A slight deviation from squareness repeated on the pages of a large form is not only offensive to the reader, but is a hindrance to the pressman and binder.

be corrected at once.¹ They cannot be corrected properly after the form has been locked up.

The methods that are customary in the imposition of large forms are sometimes unwisely neglected in small forms. A circular of two pages, to be printed on the first and third pages of the sheet by one impression, should be imposed in one form as four pages of 4to. Two pages of blanks should be made up to represent pages 2 and 4, and be imposed as if they were pages of type. To impose the third page by guessing at the blank required for head and back margins is never a safe process.

The blank pages are really needed as guides to correct position.

¹ Chases with shifting cross-bars seldom receive proper care. The chases and their detached bars are usually stood up against a dead wall, where they are bent by the superincumbent weight of other chases and bars piled against them. They are often allowed to get bruised and rusty. The bars are sometimes used as pokers or levers. Bars made for one chase are sometimes violently forced into another; slots and dovetails may be refled and clumsily altered. Under this rough treatment the chase may be twisted and made more crooked than the cast-iron chase.

Chases should be bought with

system; there need not be many sizes, but there should be many of the same size. As cross-bars are not made interchangeable, each bar should have its own number stamped on its dovetail, and on the frame nearest to its corresponding slot in the chase. Under no circumstances should the cross-bar made for one chase be forced into another chase, for this change damages two chases. When many chases of one size are provided, and each chase is numbered, the time spent by the stoneman in fitting new forms with furniture and by the pressman in adjusting margins will be sensibly diminished.



— 8

1 —



6 A circular of 2 pages only, the print on first and third pages.

INSET FOLIOS OF USUAL FORM

Account-books and diaries are sometimes printed on single sheets of flat cap (14 × 17 inches), with dates and figures following one another in proper order. The sheet of small size is selected because editions are small, and larger paper may not be had of proper size, weight, and quality. Sheets so treated are usually made up in sections of fives, and are sewed in the usual way through the longer fold. The heads of pages must be kept in parallel line, but the arrangement of pages in other features does not differ from that laid down for the legal folio. To prevent error, a dummy of each section should be made on leaves of blank paper, properly paged in writing, so that the dummy will serve as a guide to stoneman, pressman, and proof-reader. For the first section the order will be :

First sheet.	Second sheet.	Third sheet.	Fourth sheet.	Fifth sheet.
1 20	3 18	5 16	7 14	9 12
Outer forms.				
2 16	4 17	6 15	8 13	10 11
Inner forms.				

7 An inset folio of 20 pages in ten forms.







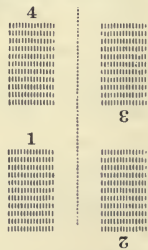

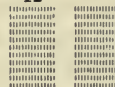
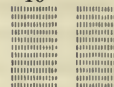

Signatures at the tail of each sheet are seldom made, but they may be helpful to an inexpert.

The legal folio is preferred by lawyers for documents, and is usually printed in four-page forms imposed the long way on the size of paper known as double legal-cap, 16 x 26 inches. It reverses the usual methods of book-work. Its leaves are fastened at the heads of odd pages; the heads of odd pages are backed upon the tails of even pages; its print is read by turning the leaves the long way on the short fold; it has a wider margin at the left than at the right of the page. The number of copies ordered is usually too small to warrant the imposition of more than four pages to the form, even when there may be six or more sheets for the document. It is always imposed to be sewed, stitched, or eyeleted together in one section only, whether that section contains few or many pages.

To produce the wider margin required at the left of each page, the furniture selected for the gutters must be about twice as wide as that given to the ordinary side-sewed book. The pressman can keep equal outer margins. As the sheet is creased or folded at the head, the head-bolt should be much wider than is customary in the ordinary imposition. Each sheet turns on the long cross, the duplicates so made being separated by cutting through the longer fold. This cut should be made with precision, for the margins will not permit retrimming.



8 Legal folio of 4 pages.

First sheet.	Second sheet.	Third sheet.	Fourth sheet.
16  16	14  14	12  12	10  10
1  1	3  3	5  5	7  7
2  2	7  7	9  9	8  8

9 Legal folio of 16 pages, imposed for insets.

MUSIC OR OBLONG WAY

Some books of music and of maps or illustrations are planned for a short and broad page that must be sewed on the narrower side of the leaf. The section so treated, known as of oblong shape, requires a different imposition of the pages and adjustment of margins, but the relative position of the pages to their mates and to one another must be the same as in the ordinary method of imposition. This sheet has to be folded for its first fold the broad way of the print; on its second, the narrow way.

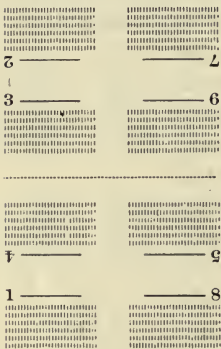

10 Eight pages in one form, oblong way.

Eight pages imposed from the centre differ from eight pages in the usual way only in the transposition of the two halves of the form. The pages in each quarter are precisely the same.

In Scheme 12 the right and left halves of Scheme 11 are transposed. When Scheme 12 has been selected, the white margin of paper on the outside of pages 8 and 7 must be, for each side, one half (no more, no less) of the blank between pages 1 and 2.

“Two on” (Scheme 13) is a phrase often used to describe the filling of a form with two (and sometimes more) duplicates of

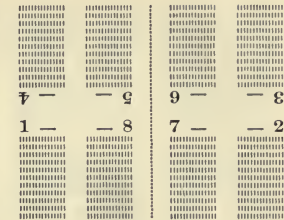

11 Eight pages in the usual way.

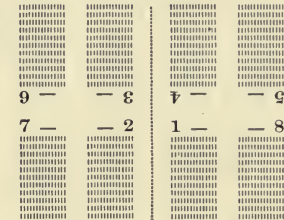

12 Eight pages imposed from the centre.

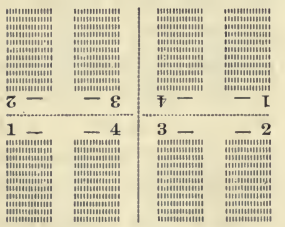

13 Eight pages in two sections of but 4 pages only, often known as “two on.”

of the same type or plates. It is frequently practised to utilize a large machine, to lessen the number of impressions and to save needless expense. The first and last four pages of a book can be so imposed with advantage.

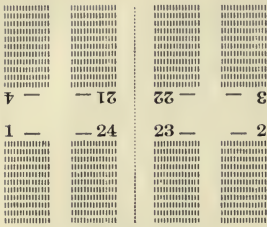

Outset of section.

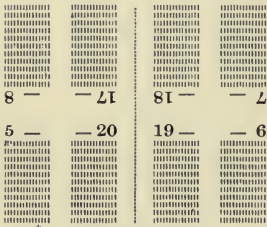

First inset.

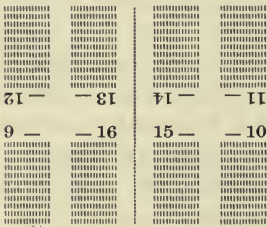

Second inset.

14 Eight-page forms in three chases, to be inset to make one section of 24 pages.

The triple scheme 14 exemplifies three half-sheets of octavo, but they are imposed in three forms, to be inset so as to make 24 pages to one section.

Note (1) that the sum total of every pair of mated pages is always 25; (2) that the twelve pages which constitute the first half of the section are at the ends of each sheet and the other half in the centre; (3) that the last pages of the outset occupy relatively the same position as pages 5, 6, 7, 8 in the ordinary octavo; (4) that the first four pages of the first inset occupy the position of the first pages in the ordinary octavo. When this order is well understood, imposing of inset sections in many forms may be done without the aid of a diagram previously prepared.

Eight pages may also be imposed the long way of the page after Scheme 15, which is sometimes used



15 Eight pages, 2 wide, 4 high.

to utilize offcuts of paper. This scheme, although not often used, may be needed for offcuts and long pages on a sheet of odd shape.

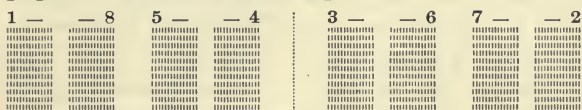

16 Eight pages for an offcut of paper.

This is another scheme for eight pages, which also shows the unalterable position of mated pages.

SIXTEEN AND THIRTY-TWO PAGES

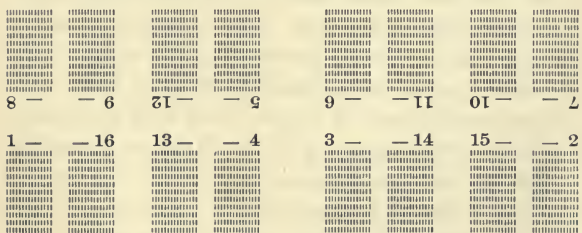

Outer form. Inner form.
17 Sixteen pages in two chases for one section.

352 *Advantages of sheetwise presswork*

In Scheme 17 the outer and inner forms are laid down side by side; but if the pages of the inner form were placed at the top of the outer form (page 2 in the upper left-hand corner), and all were in one chase, the arrangement would be that of the usual form of sixteens. (See Scheme 19.)

The outer and inner forms of the same sheet should have the pages laid down in the two chases at the same time and in consecutive order. Beginning with page 1 of the outer form, pages 2 and 3 should next be put in the inner form. Pages 4 and 5 will next be put in the outer form, to be followed by pages 6 and 7 in the inner form. This successive alternation of two consecutive pages in each chase will be continued until the last page is mated with the first page of the outer form.

One of the difficulties of sheetwise imposition is that of making register when there is a shrinkage of furniture in either form. Another is its greater liability to unevenness of color or of impression when the two forms are done on different presses and by different pressmen. But it has to be used on rotary and perfecting presses that have been constructed to deliver the sheet perfect on both sides at one operation. It is also used with advantage for very large pages, and for illustrated work in which the ink on the cuts printed on one side of the paper should be entirely dry before the second side goes to press. When an unusually large number of pages has to be put on a sheet (as in three

sixteens to a 48mo in two chases) the sheetwise method is of service, but, as a rule, the form that can be printed perfect on itself as a half-sheet is printed with more ease than if the pages were imposed in two forms.

Sixteen pages are also imposed from the centre. When the sheet has been perfected and cut in

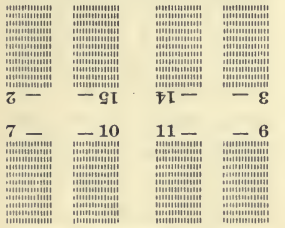
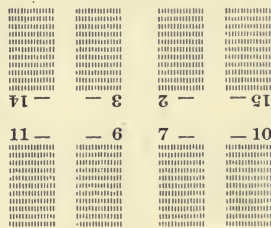
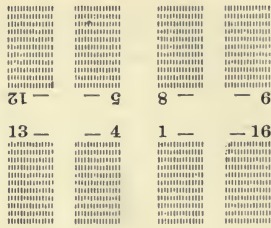

18 Sixteen pages, imposed from centre.

two, page 1 will be the outer page of the section, but the pages from 2 to 8 will be closed by bolts at head and side. Imposing from the centre reverses the position of the bolts.

Another method of imposing the 16mo from the centre can be followed by transposing in a body the pages entire on each side of the short cross-bar.

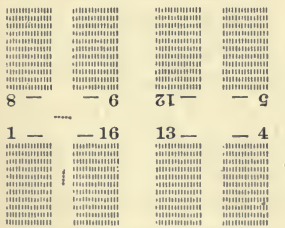

19 Sixteen pages as usually laid.

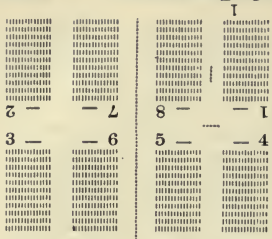

For a very long edition the section of 8 pages is often duplicated by electrotyping, so that the duplicates can be printed together on a large press. In this scheme the paper can be turned on the long cross or short cross. The sheet when perfected will make 32 pages, or four duplicates, 8 pages each.

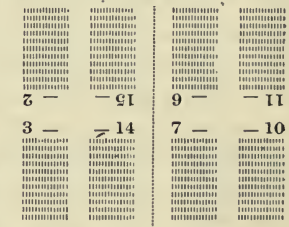
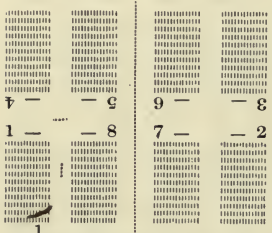

20 Sixteen pages, as two sections of 8 pages.

In the usual way of imposing sixteens the long bolts or closed leaves are those that come between pages 9 and 16. It should be also noted that in the two schemes 18 and 19 the mated pages of each quarter are alike; their position together upon the sheet is different, but their relative position to each other is not changed.

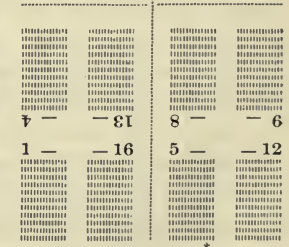

21 Sixteen pages in two portions of 8 pages for inset.

When the paper for a 16-page section is too thick to be folded, but not too thick to be sewed as a single section, it is customary to impose the full sheet of 16 pages in two parts. Each part can be separately folded, and one part can be inset in the other. This prevents the buckling of the paper between pages 8 and 9, and it saves the cost of extra sewing for another section.

This is another scheme (22) to save extra press-work and to utilize large presses. It may happen that a book of 16-page sections closes with 12 pages only for the last sheet. To print a special form of 12 pages is both inconvenient and wasteful. It is customary to impose the 12 pages for a form of 16, and to treat the excess of 4 pages as a part of the end papers in the book. Or these 4 pages can be utilized to be added to the preface matter, if a similar irregularity is there presented. Scheme 22 shows an imposition for one section of 12 pages and one of 4 pages. The sheet of 16 pages can be

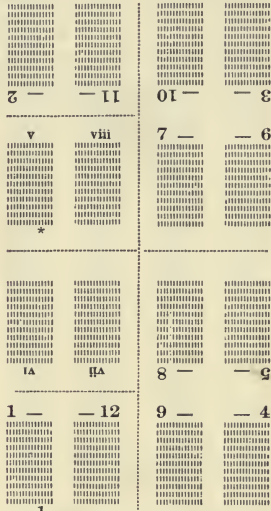

22 Sixteen pages in two portions, one of 12 and one of 4 pages.

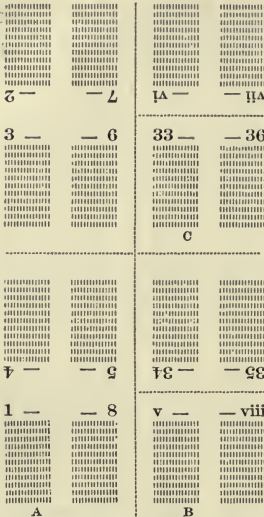

23 Sixteen pages in three sections: one 8, two 4.



24 Sixteen oblong pages, music way, one section.

folded at the same time, and the binder can then cut out the four pages v-viii with the folder, and afterward put them in their proper places in the front part of the book.

Scheme 23 when printed on both sides will be cut in six pieces, to make three sets of duplicates. For a form of 16 pages in four sections of 4 pages each, repeat on the left side of the long cross the arrangement of 4 pages for the two sections here shown on the right side.

Thirty-two pages in one section 357

Scheme 24 provides for duplicates of 16 pages each. The first and second folds of the section are the narrow way of the cut sheet; the last fold is at a right angle. Buckling of paper may be lessened by ripping the sheet half-way on the second fold with the bone folder between pages 12 and 13.

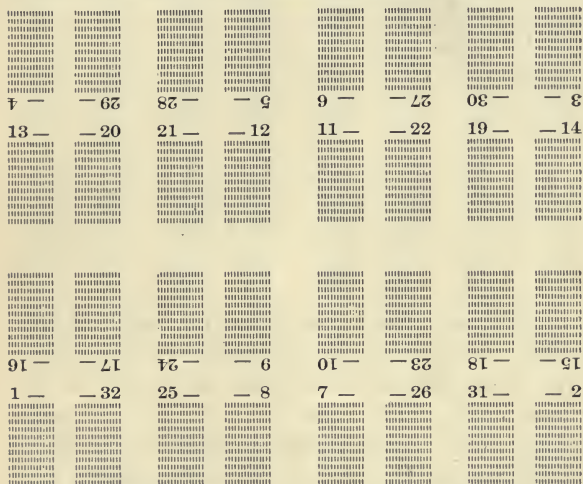

Outer form.

Inner form.

25 Thirty-two pages in two chases, to fold as one section.

Scheme 25 is entirely impracticable for a library book, and is of doubtful value for a cheap pamphlet on very thin paper. With paper of ordinary thickness it will cause wrinkling, and margins will be askew. This arrangement of pages when put in one chase is usually described as a half-sheet of 32 pages.

10 —	15 —	18 —	19 —	22 —	11 —	12 —	21 —	24 —	6 —
15 —	18 —	19 —	22 —	11 —	12 —	21 —	24 —	6 —	16 —

8 —	1 —	32 —	29 —	5 —	6 —	27 —	26 —	7 —
1 —	32 —	29 —	5 —	6 —	27 —	26 —	7 —	2 —

1

Outer form.

Inner form.

26 Thirty-two pages in two forms: two signatures of 16 pages, to be separately folded and inset to make one section. The sheet printed by Scheme 26 is cut in two pieces, making two distinct portions of 16 pages. The section containing pages 1-8 and 25-32 is folded as the outset; the section containing pages 9-24 constitutes the inset. This arrangement should not be selected for a library book, for the section so treated will be too thick. The imposition of the pages in one chase for paper of double size is usually known as a half-sheet of 32 pages, imposed for two separate foldings and one section.

For 32 pages in one form as two sections of 16 pages, rearrange the lay of pages so that the sheet

Thirty-two pages of four sections 359

can be turned on the short cross in backing up, keeping each section distinct on its side of the long cross.¹

Sixty-four pages in four sections of 16 pages each are shown in Scheme 5, on page 341. Sixty-four pages in one section is another impracticable imposition,² even if made with two or four insets.



27 Thirty-two pages, as four sections of 8 pages each.

¹ Imposing the pages for each section on distinct sides of the long cross keeps the same feed-edge of paper in printing the second side. Each section of 16 will be on half of the sheet cut the long way. See Scheme 39.

























































































































































² An approach to this problem is made by one style of machine folder which, by outward and inward folding, connects in one long strip four sections of 16 pages, conjoined but prepared for connective sewing.

71- -74	09- -62	87- -75	70- -70	85- -85	86- -86	89- -89	88- -88	0	87- -87	88- -88	90- -90	91- -91	86- -86	89- -89	89- -89	77- -77	78- -78	72- -72	1
7- -10	51- -51	11- -11	6- -6	21- -21	28- -28	25- -25	24- -24	2	81- -81	13- -13	23- -23	26- -26	03- -03	01- -01	22- -22	4- -4	31- -31	91- -91	1
39- -42	4- -4	43- -43	38- -38	53- -53	52- -52	19- -19	60- -60	3	05- -05	30- -30	55- -55	68- -68	29- -29	19- -19	54- -54	37- -37	44- -44	41- -41	40- -40
43- -43	94- -94	95- -95	35- -35	52- -52	19- -19	40- -40	67- -67	4	05- -05	30- -30	55- -55	68- -68	29- -29	19- -19	54- -54	37- -37	44- -44	41- -41	38- -38
7- -10	51- -51	11- -11	6- -6	21- -21	28- -28	25- -25	24- -24	5	81- -81	13- -13	23- -23	26- -26	03- -03	01- -01	22- -22	4- -4	31- -31	91- -91	1
39- -42	4- -4	43- -43	38- -38	53- -53	52- -52	19- -19	60- -60	6	05- -05	30- -30	55- -55	68- -68	29- -29	19- -19	54- -54	37- -37	44- -44	41- -41	40- -40
71- -74	09- -62	87- -75	70- -70	85- -85	86- -86	89- -89	88- -88	7	87- -87	88- -88	90- -90	91- -91	86- -86	89- -89	89- -89	77- -77	78- -78	72- -72	1

28 Ninety-six pages in one chase: six sections of 16s.

This form is more practicable with plates than with type. Exact register will be facilitated if the four mated pages are cast together on one plate.

One hundred and twenty-eight pages 361

 90  101  108  101  97  112  109  100  7	 190  191  194  117  113  128  125  116  8	 118  123  129  119  115  126  127  114  99  110  111  98	 102  107  101  103  99  110  111  98
 72  73  76  68  65  80  77  68  5	 88  89  92  92  81  96  93  84  8	 98  91  90  87  83  94  95  82  67  78  79  66	 71  74  76  70  67  78  79  66
 40  41  44  37  39  48  45  36  3	 56  57  60  52  49  04  61  52  4	 94  69  89  86  51  62  63  50  35  46  47  34	 88  43  42  89  35  46  47  34
 8  9  12  5  1  16  13  4  1	 24  26  28  21  17  32  29  20  5	 22  27  26  23  19  30  31  18  8  14  15  2	 7  10  11  6  7  10  11  6

29 One hundred and twenty-eight pages in one chase :
eight sections of 16 pages each.

The scheme of 128 pages in one chase is possible for very small pages and thin sections only. In two forms, outer and inner, of 64 pages each, the 128-page scheme is more manageable, and especially so when the outer form contains the illustrations and the inner form has plain type only. When there are illustrations that may require special treatment in making ready, the smaller form of 64

pages in sections of 16 pages only, as shown in Scheme 5, will be more useful for small editions. Separate sections of 16 pages, when paper is of ordinary thickness, are preferred by all printers and binders. The schemes of this book could be increased by presenting others for sections of 24 or 32 pages, but they would prove of no service for a neat book. The methods occasionally adopted by the publisher of cheap advertising pamphlets, who tries to reduce the cost of manufacture by printing too many pages in one form on a large sheet, and by folding the sheet so printed in sections of 32 or more pages, cannot be safely imitated in strict book-work. Forms of many pages are not economical for small editions. Even when the pages in a form are not too numerous, the unskilled compositor is specially warned against making too thick sections with intent to reduce the cost of folding and sewing. Thick sections will not save time or expense. What may seem to be saved in one direction will be more than lost in another, and the book of thick sections will be condemned as unworkmanlike and may be entirely unacceptable. The smaller the leaf the more the need of thinner sections.

For the large sheets printed on rotary or flat-bed perfecting presses, that will be folded by the newer styles of folding-machines, these schemes will not serve, for machines differ from one another in plan and construction. Pages must be imposed by the schemes of the manufacturer of the machine.

TWELVE PAGES AND THEIR DUPLICATES

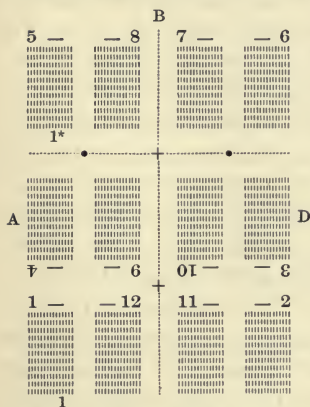

Scheme 30 is an 8vo with an added 4-page inset, within which octavo part this inset can be folded by the same operation, or can be cut off for a separate folding and subsequent insertion. The sheet is made perfect on the second side by turning it on the long cross-bar of the chase.¹

30 Twelve pages in one chase. Turns on long cross. because in old methods of imposition they were cut off and separately folded to be inserted as an inset between pages 4 and 9. By this old method the running title and its folio figure were always placed at the tail of pages 4, 9, 10, 3. This treatment, unavoidable on rough paper, often produced uneven head margins and a crooked inset. This fault can

¹ In presswork the first side of the sheet is laid up to guides against edges AB; the second side, against edges BD. To get correct register by feeding, the sheet should be trimmed accurately square on all sides. If the paper is crooked or if it is hand-

made with rough edges, points should be inserted on the first side, as marked in scheme, for its reprinting on second side. The black dots in Scheme 30 mark the usual place of points for hand-press; the +, the place of points for cylinder.

be prevented by the use of truly squared paper, by putting the heads of the so-called offcut pages against the edge of the sheet, and by giving an increased amount of blank where the tail of the offcut part meets the tail of the octavo part of the sheet. The pressman should feed paper to the offcut edge and give to its head margin one half of the blank provided in the head-bolts of the octavo part of the sheet. When these precautions have been taken, the head margins of an inset offcut can be made as true as those of a folded 16mo.

Pressmen dislike the 12mo because its turn on the long cross causes delay and trouble; publishers dislike it because it is expensive in folding and has greater liability to untidiness; yet it is a form that must be used often. On hand-made papers with rough edges, the heads of the offcut must be placed after the old method at the tail of other pages, but points must be used. On smooth-edged paper the turning out of the heads for the offcut is a better practice, and the points may be omitted.

Twelve pages can be imposed from the centre by transposing in a body pages 4, 9, 1, 12 with pages 10, 3, 11, 2. Offcut pages need no change.

At the tail of page 5 in Scheme 30 appears 1*. The star indicates an inset: 1* for the first and 1** for the second inset of the complete section. The purpose of the repeated signature figure with star attached is to identify the offcut and to show its connection to the outset. In a bindery where

double leaf following the outer one is pushed outward a little more than the thickness of its paper. This outpush varies; it is about a lead more on the second leaf, and it increases uniformly with every added leaf in the section. In the book planned for wide front margin, a difference in width of two or three leads is unnoticeable and may be disregarded; in the rule-bordered 32mo of small size, planned for margins of one-third or one-quarter inch, variation becomes a serious fault which will require much care for its prevention.

To prevent this fault, the back margins of inner leaves must be narrowed with system. The back margin of the outer double leaf needs no alteration, but that of the second double leaf should have about one lead less. The third double leaf, and every added one, should have a narrowing in the same proportion, in all cases depending on the thickness of the paper. The blank taken out of back margins must be restored in two equal parts to the front margins of the leaves from which the blank has been abstracted. This readjustment is exceedingly troublesome.

It is better practice to have this readjustment done on the stone in forms that are being prepared for electrotyping, the stoneman being notified of the paper that will be used and of the scheme of imposition. In the ordinary scheme of 16 pages in one section, the two pages 1-16 should be prepared for electrotyping upon one plate with the regular

back margin. Pages 2-15, that back 1-16, also in one plate, should have the same back margin. Pages 3-14 and 4-13 of the second leaf should have one lead less in the back margin; pages 5-12 and 6-11 of the third leaf, two leads less; and 7-10 and 8-9 of the fourth leaf, three leads less. The electrotyper may need the caution to bevel all these double-paged plates to uniform size, not bevelling an outer margin too close to type-work because the margins have been made intentionally unequal. Plates so made will seem out of line when adjusted upon blocks, but the pages will be in line when the book has been properly printed, folded, and trimmed. All the outer margins will be of uniform width; the abstracted blank in the back margin will not be noticed. This method of electrotyping two and sometimes four pages upon one plate has this additional advantage: it saves the time of the pressman and improves the register.

The appearance of the ordinary 24mo of one section can be made more sightly by reducing the width of back margins of the offcut by this system, even when the margins of the 8vo part of the sheet remain undisturbed. This change can be made in the offcut with little trouble.

Twenty-four pages can be imposed to produce two sections, one of 16 and one of 8 pages, by putting pages 1-16 on the two-third part of the sheet (making it an independent section), and by putting pages 17-24 for the other section in the

one-third or offset part of the sheet. This also must be folded the long way.

Twenty-four pages can also be imposed for three sections of 8 pages by treating each row of pages as an 8vo to be folded the long way. See Scheme 16.

Twelve pages, in a form of similar triplicates of 4 pages each, are often used for the printing of pamphlet covers. Care must be taken to have truly squared paper and exact cutting and folding, for the paper must be turned on the long cross, and the sheet must present different edges to the feed-guides. The heads of all sections can be laid one way, as here shown.

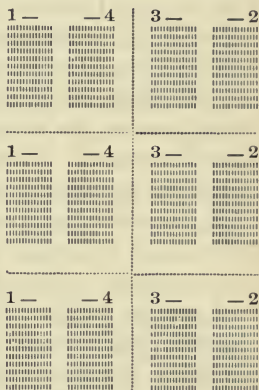

Sections of the same thickness favor neat binding. When a section of 16 pages is followed by

another of 8 or of 4 pages, the gatherer may overlook the thin section. A book that has uneven sections is rarely ever neatly sewed; its leaves open stiffly and show unsightly gaps at its joints. Thin sections are sometimes unavoidable, but they should be prevented when prevention is possible. Schemes for sections of unequal thickness in forms of many pages are most useful when the additional small

32 Twelve pages in one chase, similar triplicates of 4 pages each.

sections save presswork or waste of paper. They could be largely increased in this book, but to no advantage. They are not helpful but confusing to the young compositor, for they lead him to use schemes that call for complicated folding.

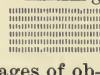
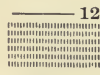
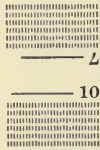

33 Twelve pages of oblong shape, no inset, central imposition.

The six outer pages that come first and appear on the left side of Scheme 33 are on one side of the long cross; the six pages that come last are on the other side; but the sheet is perfected by turning it over the short cross in the usual way. The sheet is cut in halves: see rule between pages 1-2 and 11-12, which makes duplicates of them. Pages 5, 6, 7, 8 turn in on the first fold. The second fold is made on the same parallel between pages 3-2 and 10-11. Last fold is on the narrow way of the paper.

In Scheme 34 that follows the sheet turns on the long cross, and two parallel folds have to be made. It is intended to have the offcut (pages 9-16) separately folded and inset. The folding in of the inset, unavoidable in cheap and hurried binding, is too often inaccurate as to margins.

370 *Names and proportions of leaves*

 <p style="text-align: center;">11 ——— 14</p>	 <p style="text-align: center;">13 ——— 12</p>	 <p style="text-align: center;">19 ——— 20</p>	 <p style="text-align: center;">23 ——— 24</p>
 <p style="text-align: center;">5 ——— 8</p>	 <p style="text-align: center;">8 ——— 21</p>	 <p style="text-align: center;">19 ——— 6</p>	 <p style="text-align: center;">23 ——— 2</p>
 <p style="text-align: center;">1 ——— 1</p>	 <p style="text-align: center;">1 ——— 1</p>	 <p style="text-align: center;">1 ——— 1</p>	 <p style="text-align: center;">1 ——— 1</p>

34 Twenty-four pages, oblong shape,¹ inset of 8 pages.

The pages could be laid for a folding in of the inset, but its separate folding will make a neater section.

¹ In advertised descriptions of books, some publishers specify the paper-trade name of the paper used before they add the name of the shape or the fold of the leaf, but this practice is not general. Sizes of paper differ and the names of leaf-shapes differ in different countries. It follows that the descriptive names of sizes and shapes are often confusing and may be misleading. The table annexed gives names that are in frequent

use, but they are not so called everywhere. The figures give relative proportions in inches.

<i>Name of leaf.</i>	<i>Height.</i>	<i>Width.</i>
Regular or standard	9	6
Broad or wide	9	6½
Quarto shape	9	7
Long or deep	9	5
Extra long or narrow	9	3½
Oblong or music way	9	13

Variations of a half-inch in the height are seldom explained by any change in name.

Twenty-four pages by two impositions 371

9 — — 16	13 — — 12	11 — — 14	15 — — 10
1*			

8 — — 21	07 — — 9	9 — — 6I	8I — — 4
1 — — 24	21 — — 4	3 — — 22	23 — — 2
1			

35 Twenty-four pages in one chase, with offset of 8 pages to be inset and make one section.

5 — — 8	17 — — 20	19 — — 18	7 — — 6
1*	2*		
4 — — 6	9I — 12	22 — 17	15 — 10I — 8
1 — — 12	13 — — 24	23 — — 14	11 — — 2
1	2		

36 Twenty-four pages in one chase, for two sections of 12 pages each, offsets to be separately folded and inset.

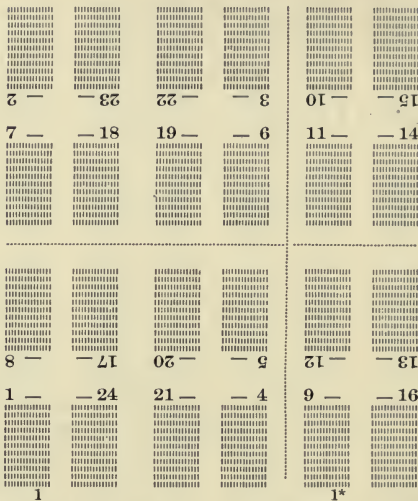

37 Twenty-four pages on the square sheet, with offset of 8 pages, to be inset to make one section.

For the 24mo in one chase, two shapes of paper are made: the square shape, for which the pages must be imposed 4 pages high and 6 pages wide; the long shape, 3 pages high and 8 pages wide. For the ordinary 12mo leaf, $5\frac{1}{8} \times 7\frac{3}{8}$ inches, the square paper is $30\frac{3}{8} \times 30\frac{3}{8}$ inches, an awkward shape. The long paper, 23×41 inches, is handier, and is usually preferred. For long editions the 32-page form on paper 30×40 or 31×41 inches is selected.

Sixteen-page impositions, for cross folds and without insets, are best fitted for hand folding.

Twenty-four pages on square sheet 373

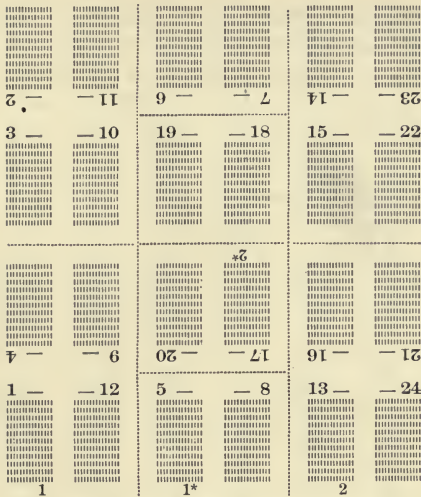

38 Twenty-four pages on the square shape of sheet, for two sections of 12 pages.

This sheet turns on the short cross. When perfected it is first cut in three long strips. The outer strips (signatures 1 and 2) are folded separately as 8vos. The inner strip, that bears the signatures 1* and 2*, is cut in four pieces, making duplicates of each signature, which are separately folded and inset in their proper order. The outer strips are each subdivided in two equal parts for the insertion of the insets. Scheme 38 makes troublesome folding. It should not be selected when paper of proper size can be had that will permit the use of Scheme 35, which is more approved by publishers.

374 *Forty-eight pages in three sections*

For twenty-four pages in one chase, the long shape of paper, usually 23×41 , is to be preferred for the ordinary duodecimo of $5\frac{1}{8} \times 7\frac{3}{8}$ inches.

39 —	40 —	41 —	44 —	37 —	38 —	43 —	42 —	39 —
34 —	33 —	48 —	45 —	36 —	35 —	46 —	47 —	34 —
3								
23 —	24 —	25 —	28 —	21 —	22 —	27 —	26 —	23 —
18 —	17 —	32 —	29 —	20 —	19 —	30 —	31 —	18 —
2								
7 —	8 —	9 —	12 —	5 —	6 —	11 —	10 —	7 —
2 —	1 —	16 —	13 —	4 —	3 —	14 —	15 —	2 —
1								

39 *Forty-eight pages in one chase, as three distinct sections of 16 pages each, for the square shape of paper.*

Twenty-four pages in three separate sections of 8 pages each can be made by triplicating in one chase Scheme 15 or 16 for 8 pages.

The sheet for Scheme 39 turns on the long cross. When perfected it is cut in six pieces, as marked, and each section is folded as a regular 16mo. Its turn on the long cross, for printing on the second side, compels a new feed-edge of paper to be presented to the grippers—a treatment always objectionable to the pressman. To impose the pages to turn on the short cross gives extra trouble to the binder, and risks imperfect workmanship: the upper and lower tiers of 16 pages each must be treated as widely separated but regular sixteens, as in Scheme 19; the middle tier of 16 must be cut at the head, to fold by consecutive parallels.

For 48 pages in two sections of 24 pages each, but in one chase, repeat on each half of the short cross the imposition of Scheme 37, or treat them as the lower two thirds of Scheme 44. It is not an imposition to be recommended.

A scheme for 48 pages in one chase, to be folded together in one section, is quite impracticable even for a common pamphlet on very thin paper. It is never selected for a library book, for it cannot be folded neatly or be trimmed with true margins. A section of 32 with inset of 16 is clumsy. It is little better to put the pages in two parts of 24 pages each, one to be inset. For all side-stitched pamphlets prefer thin sections. The paper cover

376 *Seventy-two pages in one chase*

can be pasted on the back of sections more firmly, and it will not sprawl outward at the fore edge.

41—44 4*	53—56 5*	65—68 6*	67—66 6*	55—54 6*	43—42 6*
07—07 4	62—62 5	69—69 0	04—03 6	89—19 6	97—68 6
37—48 4	49—60 5	61—72 0	71—62 6	59—50 6	47—38 6
5—8 1*	17—20 2*	29—32 3*	31—30 6	19—18 6	7—6 6
7—6 1	91—16 2	86—88 3	78—26 6	66—91 6	01—8 6
1—12 1	13—24 2	25—36 3	35—26 6	23—14 6	11—2 6

40 *Seventy-two pages in one chase: six sections of 12 pages.*

Scheme 40 is practicable for very small leaves only. In adjusting margins and making register it will be more manageable if divided in two chases as an outer and an inner form of 36 pages each. It turns on the short cross and is cut in twelve equal parts, making duplicates of each section. The form could be divided in three sections of 24 pages, but not to advantage for a library book of neat binding.

EIGHTEEN PAGES AND THEIR DUPLICATES

The 18mo in one signature is an imposition to be avoided, for it compels a transposition of pages on press when the first side of the paper has been printed, and it is troublesome to fold. It is occasionally selected for single-sheet pamphlets, because it makes a shapely leaf for the common sizes of paper 19×24 and 22×28 inches.¹

The 36mo and 72mo do not require a transposition of pages, but they delay folding, and are selected by publishers only when paper of suitable size and quality cannot be had for sections of 16mo.

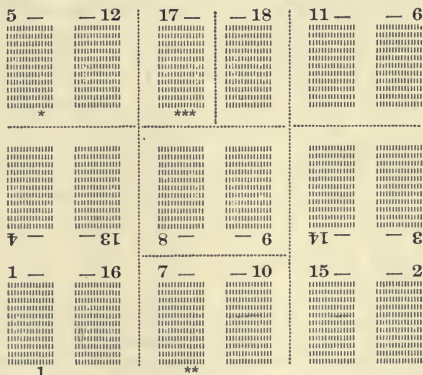

41 Eighteen pages in one chase, for one section. It requires two insets, a tipped leaf, and transposed pages.

¹ The 18mo of paper 19×24 is $4 \times 6\frac{1}{2}$ inches, and that of paper 22×28 is $4\frac{3}{4} \times 7\frac{1}{2}$ inches. The regular 16mo foldings of these papers are wider and shorter, and to many readers the square 16mo of regular fold is a squatly and objectionable shape.

In Scheme 41 the paper turns on the short cross. The two outer tiers of mated pages are at the ends of the sheet, where they back one another properly. So do pages 17 and 18 in the offcut; but pages 7-10 and 8-9 would be wrongly backed by this turn upon the short cross. When the sheet has been printed on the first side, page 7 must be transposed with page 9, and page 8 with page 10. The transposition of pages in the form produces the same result as the turn on the long cross.

In folding, the sheet is cut in three long strips, as marked with dotted lines in the scheme. Pages 5-12 and 6-11 are in an offcut that is inset in the larger folding. The centre tier is then cut in three equal parts, and pages 7-10 and 8-9 make another inset. This leaves one third of the centre strip with pages 17-18. As they have no mated leaf, it is necessary to cut them through the centre and paste them down on page 16 at the end of the signature. It is not an imposition to be recommended, for the sheet has to be cut in eight pieces and requires special care in folding.¹

¹ The 18mo without transposition is laid down in some manuals: page 7 lines with 8 and page 9 with 10; the centre tier of pages is cut through the back margins, making three single leaves that must be pasted down in the centre of the complete section. The inconvenience of transposition is not so great as that produced by the handling of three single

leaves and the insecurity of an unworkmanlike binding. It may be tolerated in the side-stitched pamphlet of one sheet only, but not as a section of a book for the library. Other schemes for the 18mo in one section are equally troublesome, and they should be accepted only as a last resort when no other imposition can be used.

In Scheme 42 the objectionable single leaf is cut out. This permits a more shapely leaf than can be had from the ordinary fold of 16mo on paper of regulation size. The pages in the middle tier must be transposed for the second side: pages 7-10 and 8-9 are changed in the same way as was directed on page 378. The heads of the pages in the offcut are reversed so that this part can be turned in and folded up with the body of the sheet, but the work will be neater if the offcut is separately folded.

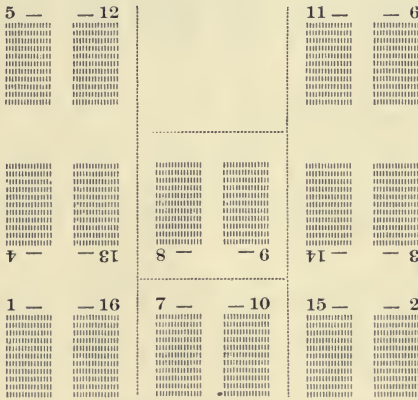

42 Eighteenmo fold of 16 pages only, one leaf cancelled.

Scheme 43 is practically three series of 12 pages imposed together to produce small sections of a convenient thickness. The offcut will be most satisfactorily treated if it is separately folded.

5 — — 8
1*

17 — — 20
2*

29 — — 32
3*

4 — — 6
1

9 11 — — 12
2

28 — — 33
3

1 — — 12
1

13 — — 24
2

25 — — 36
3

Outer form.

2 — — 11

17 11 — — 22
1

27 — — 34
2

3 — — 10

15 — — 22
1

27 — — 34
1

9 — — 2

8 11 — — 61
1

08 — — 18
1

Inner form.

43 Thirty-six pages in two chases: three sections of 12 pages each.

TWENTY, FORTY, AND EIGHTY PAGES

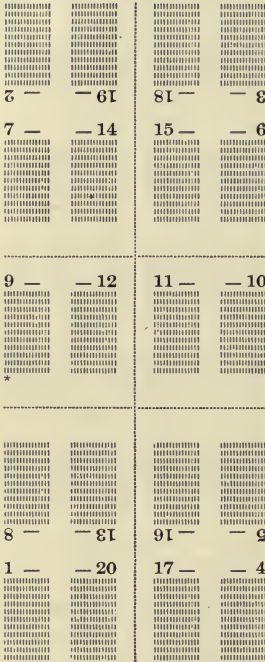

Twenty pages can be imposed as a 16mo, with an added inset of 4 pages, by putting the 4-page inset in the centre tier and making the two upper and the two lower tiers the halves of a regular 16mo. The four pages of this centre tier must be transposed when the sheet is ready for printing on the second side, and the sheet after printing must be cut in six pieces, as has been indicated in a previous scheme. Transposed pages 9, 12, 11, 10, can then be inset in the centre of the 16-page part, making the complete section of 20 pages.

45 Twenty pages in one chase, as one section, to turn narrow way of paper.

Twenty pages can be imposed without a transposition by putting the offcut of 4 pages at the extreme end of the form and turning the sheet on the long cross, but this method of turning the sheet may be as objectionable as the

Twenty pages without transposition 383

transposition of pages or plates. (See Scheme 46.) The pages of Scheme 45 can be rearranged to make two sections: one of 16 and one of 4 pages, or one of 12 and one of 8 pages.

In Scheme 46 a transposition of the pages of the inset is avoided by turning the sheet on the long cross. The sheet, first cut the long way, has two parallel folds the narrow way before the inset is inserted.

When pages are in the customary proportion of width 1 to height $1\frac{1}{2}$, the 20-page form will be long and narrow and not properly adapted to the shapes of paper kept on sale. To avoid waste, paper has to be made to order of prescribed size. Papers on sale are adapted only for the small quarto shapes of 20mo forms.

Scheme 47, practically a sheet of 32 pages with an added inset of 8 pages, may serve for a cheap

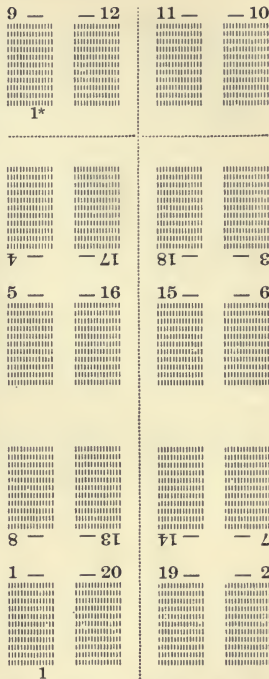

Eighty pages in one chase, in five sections of 16 pages each, can be imposed, 8 pages high and 10 pages wide, for a more shapely sheet of paper. The inseting of many sections is to be avoided, for it produces a bunched back and uneven margins.

THE LEAFLET

Leaflet is the name given to folded but unsewed leaves of 6, 8, or more pages. A rule border about every page is common; the space between pages is narrow but uniform in width. There is no arbitrary rule about imposition: the first page may be to the left, to the right, or in the centre, but the pages following page 2 are laid down in any way that establishes their relation one to another.

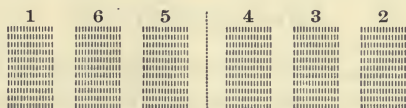

First page at right in print.

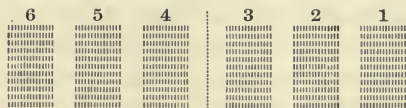

First page at left in print.

48 Six-page leaflets in strip 1 page high.

These pages are to be printed on a long slip of paper, and to be turned on the short cross to make duplicates. The leaflet of 10 or more pages is

generally imposed 2 pages high, to turn on the long cross, so that the sheet can be cut through its longer diameter. This treatment makes the press-work of leaflets on small presses more manageable.



49 Ten-page leaflet 2 pages high.

To make sure of exact register, the paper for leaflets should be squared and accurately trimmed.

SMALL PAMPHLETS

Printed pages with narrow margins on leaves $1 \times 1\frac{1}{2}$ inches, and sometimes still smaller, may be required of the printer. To make up a form of very small pages after the methods of ordinary bookwork, to fold, sew or stitch, and trim each one separately, calls for nice attention to detail. These pages are usually printed in small forms on small presses. When there are many pages to be folded together, or even when the section has an inset, the suggestions for the narrowing of margins made on pages 366-7 of this work should be followed. Care in folding, stitching, and trimming is needed.

Small pamphlets of 8 pages can be printed and bound with neatness and economy by electrotyping the pages to make four or more duplicates, which may be imposed after this scheme with heads one way, and without any allowance for the waste of paper in trimming :



50 Eight pages in quadruplicate, or "four on." Sheet turns on short cross. Produces eight copies.

For this purpose the paper must be neatly squared before it is put to press. When perfected the sheet should be accurately cut once through the centre, so that each entire half of the paper can be folded

in one piece by edges of paper and not by print. Each half of the sheet may then receive a separate sewing or stitching for each single pamphlet. This done, the folded work may be put under the smashing-machine to reduce the paper to a manageable flatness for the cutting-machine. If the head and tail margins have been accurately adjusted, the knife that cuts them apart will, by the same cut, effectually trim heads and tails. This method saves time, but it is not practicable for thick paper. Thin pamphlets can be imposed "three or four on," so that each half of the perfected sheet can be folded together and stitched and cut apart, and this will save the expense of a separate folding, stitching, and trimming for each pamphlet.

A NEW METHOD OF COLLATING

A gathering of the different sections of a book that has its signature-marks at the foot of the page unavoidably conceals all these marks but the one on the first section. To make sure that the gatherer has assembled the sections in consecutive order, the collator must quickly but somewhat imperfectly separate the sections and verify their order by count. This separating and counting of the sections causes some delay, and may tend to mental confusion from its monotony when the work is done in haste. A gathering may be passed that has a section doubled or transposed or omitted entirely.

To prevent this fault a new system of collating-marks has been devised that enables the collator to check the sections rapidly without separating them. The new marks are bits of flat-faced brass rule, about one quarter of an inch long and three points wide, that are printed exactly upon the central folding of the back margin of the outer leaf of each sec-



tion. Each bit of brass rule is placed in a different position on its own section, so that the combined rules shall present the appearance of a diagonal black line with breaks at graduated distances. So treated, the collator can see at first glance whether all the sections are or are not in numerical order. A section doubled will show a noticeably thicker black line; a section omitted, a white gap; a section misplaced will break the regularity of the diagonal line. As these narrow black lines are completely hidden by sewing, gluing, and binding, they are no disfigurement to the bound book. For thick pamphlets to be bound in haste this new method is of value.

FOLDING-MACHINES

Many of the schemes in this chapter are suitable for the old forms of folding-machines that still keep in favor. There are, however, machines for which they are not fitted. To meet increasing demands

for greater speed and reduced cost, printing- and folding-machines have been introduced that take on sheets of unusually large size, with new devices for automatic feeding, pointing, and folding. They are made by different manufacturers from different plans, but they have little flexibility; as a general rule, they can fold sheets in one way and no other. The scheme required for one is impracticable for another. In one variety of machine, the bolts of folded leaves are at the tails and not at the heads of pages; in another, 64 pages are first folded alternately forward and then backward in four parallel strips, and lastly cross-folded to produce four un-separated sections of 16 pages each; in another, the sheet is first cut in parallel strips, and one strip is overlapped by another and again cross-cut by the last operation of the folding device.¹

These machines are most useful for magazines and work of like nature that must be done quickly and at small cost. In the hands of careful operators they can do accurate folding, but for general service on short editions bookbinders prefer hand-work or the older and simpler forms of folders. For

¹ The schemes shown in the guide-books of the manufacturers appear strange to the inexperienced, but they all conform to the general rules that must govern all impositions: the first and last pages of each section must be mates; these mates are always one odd and one even page; the sum total of any two

mated pages must be one more in number than the entire number of pages in that section. When the imposer of pages or plates has studied the scheme, and knows how the sheet will be turned or how the pages will be lapped, he will need the manufacturer's guide-book for a first imposition only.

this reason it is not practicable to present a series of schemes of imposition for machine-folding that would prove generally useful.

The forms for some kinds of machine-folders need points or slitters (and sometimes both) as aids to accurate register. The proper position in the form for these devices varies in different machines, and special direction for this purpose should be had from the binder who will fold the sheets. For a form of many pages on the double sheet, the points are usually put fifteen inches apart, one tier or row of pages distant from the centre of the full sheet. When the sheets are printed on the reverse side the points will appear in a similar position on the other half of the sheet. It is to be supposed that the sheet will be accurately cut in halves by the circular knife attached to the printing-press. The cut edge so produced will be the feed-edge of the folding-machine.

The slitter is a bit of brass rule, five eighths of an inch face (to be had of the manufacturer of the folding-machine), which is screwed down immovably on wood furniture in the form. The attachment of the slitters is a work of nice discretion. They must perceptibly stab through the paper in the act of impression; but if set too high they will blacken the sheet, cut the tympan, and gash the inking-rollers. It is customary to set them a trifle lower than type-high, and to depend upon a pasted overlay attached to the tympan for a perforation

of the paper to be printed. This treatment that prevents one fault may make another. An overlay too thick will cause the sheet to stand off too far from the tympan and be the cause of bad register. The cutting of the tympan must be avoided, but exact register must be had. Experience is needed for the proper adjustment of the slitters.

CONCLUDING REMARKS

The schemes of this chapter are for books to be sewed and not side-stitched. The widths of margins (but imperfectly presented by reason of the small size of the diagrams) are those of books planned for cloth cases. For pamphlets or magazines to be side-stitched with thread or wire, the back margins should be much wider and the front margins narrower. Some printers make the front and back margins of the side-stitched pamphlet nearly equal in width, allowing but one pica or two picas more for front margin. This is done in the belief that the wire stitch will conceal as much paper in the back as will be wasted in the front by the knife of the bookbinder when he trims the fore edge. This concealment and waste of paper is too variable to be provided for by an arbitrary rule. The adjuster of margins should consult the binder as to the probable loss of paper, and regulate his margins accordingly.

Offcuts should be inset in the central fold of the larger part of the sheet from which they have been separated. To plan a separate section of the offcut, to follow the larger part, will compel needless sewing and make improper stiffness in opening the leaves of the bound book. This suggestion applies to thin paper only. Thick sections should be avoided, especially when the leaves are small and the paper is thick. In a form of 24 pages on thick paper it will be better practice to impose for two sections of 12 or three sections of 8 pages. This treatment does not conduce to cheapness, but it does produce better work even for the side-stitched pamphlet. The paper cover is seldom neatly pasted over thick sections; cover and leaves will yawn.

In Hebrew and other Oriental languages, reading proceeds from right to left in every line; the first page of the book is on the leaf that Western usage gives to our last page. This reversal of our order compels a similar change in the imposition of pages of Hebrew, but the change is quickly understood, and does not require special schemes. In the 16mo, page 1 is put where page 16 is placed in the printed scheme; page 2 displaces 15, and every page following pursues the same order.

The increased width that should be given to the back margin of a pamphlet with a paper cover should never be determined by a guess as to the probable thickness of the sections. A dummy of all the sections properly sewed or stitched is the

only certain guide. The purposed irregularity of margins in the pages of the text (least at back, more at front, and most at tail) is usually preserved on the outer pages of the cover. When the cover paper is intended to overlap all the edges in "circuit style," this irregularity must be increased. For pamphlets trimmed on three sides, the print of cover may be ordered with even margins all around.

For a book of prescribed dimensions, paper of too large size is sometimes furnished. If the excess of paper is trivial, the adjuster of its margins may add this excess to the width of the blanks previously provided for the front and tail margins, so that it can be trimmed off by the binder in the gathered sections, but in no case should the back or head margin be enlarged. For much excess (and even for small excess) it is better practice to have the surplus cut off before the margins are adjusted. A sheet with overplus of paper on one or both ends is always inconvenient to feeder and folder. It leads to the making of faulty margins, to improper folding and reckless trimming.

The blanks about pages should be calculated with exactness, so that the printed pages can be folded with proper margins by the edges of the paper as truly as by print. The more pages in the form, the more the need of exactness. A true sheet of its own paper is the best guide for determining the proper distance between pages, which should be used as is shown in illustrations on pages 303 and

304 of this book. When the paper has rough or unevenly cut edges, or when a form has to be made up before the paper is in the house, a measuring-rule may be used, care being taken in all cases to have the exact size of the average sheet.

In these schemes the representations of chases, cross-bars, quoins, and furniture have been omitted as not helpful to a clearer understanding of the orderly arrangement of pages. They divert the eye from the order of pages, which is the chief purpose of the schemes. Cross-bars, always useful, are not always possible. In forms of plates laid on blocks, and even in some forms of letterpress, they may have to be rejected or be placed in different positions from those in the diagrams. As every printing-house has chases of various sizes and shapes, the furniture of each form must be accommodated to the chase and its types. For the ordinary form of type, the customary disposition of its furniture is indicated in the illustrations on pages 63, 303, 304. To repeat these adjuncts in every scheme is not of any advantage.

The lines of dotted rules in the schemes, that indicate where the printed sheet must be cut by the hand-folder, are attachments of importance. To the novice in imposition they show the correlation of pages that must be kept in distinct sections, when these pages are laid down in different parts of the sheet. This grouping together of the pages of separate sections facilitates the study of their

arrangement. In Scheme 5 (page 341) the relation of pages to one another in different parts of the sheet is made plainer by color.

The purpose of this chapter is not to present schemes that will be copied unthinkingly by a young compositor; it is to lead him to an understanding of elementary principles, so that he can formulate new schemes for emergencies. Suggestions and explanations that may be helpful accompany many of the diagrams.

The study of imposition has been made needlessly repelling by the exhibition of too many schemes. Some are obsolete and others impracticable. It was the intent of the writer to present only the schemes that are in regular use for the ordinary sewed book of thin sections, but the frequency of positive orders from some economical publishers of pamphlets for one thick section has led me to add a few schemes that are not recommended. This is done reluctantly, for thick sections make mean bindings. It is believed, however, that the increasing use of wire-stitching machines will lead to a general preference for thin sections and a more tidy binding of the cheap pamphlet.





OTTMAR MERGENTHALER

X

MACHINE-COMPOSITION

A review of methods . . . General organization . . . The assembling and keyboard mechanisms . . . Learning to operate . . . Management of the machine . . . Temperature of metal . . . Treatment of matrices . . . Treatment of spaces . . . The melting-pot . . . Mould and disk
The assembling elevator . . . Correct keyboard fingering

A REVIEW OF METHODS



OR many years it has been the dream of inventors to provide a mechanical substitute for hand-composition, and many hundred patents have been granted in America and Europe on machines for this purpose.

An early method proposed was to print the matter by a machine similar to a type-writer, in transfer-ink on paper, and to transfer the print so made to a

lithographic stone, or a plate of zinc or other metal from which printing could be done by lithographic processes. In other cases the metal plates were etched in order to leave the transferred characters in relief.

Many experimental machines have been constructed for impressing type-characters in the required order in papier-mâché, lead, or equivalent material, thus forming matrices for lines or pages, from which stereotype plates were cast.

Many machines have been proposed and constructed for setting ordinary founders' type. Certain of these machines, such as the Thorne and the Burr, were adapted to set the type in continuous lines, which were divided into shorter lengths by a second operator and justified by hand.

Numerous patents have been issued for machines adapted to compose ordinary founders' type and automatically justify the lines by inserting founders' spaces.

The celebrated Paige machine, originally constructed in Hartford, which was successfully operated for a time in the office of the Chicago *Herald*, was of this character. It composed the type from standing magazines, automatically inserted the spaces necessary for justification, and delivered the matter leaded or unleaded, as required, into the galley. The same machine also received the dead matter and distributed the type into the channels on the machine. The machine failed of commercial

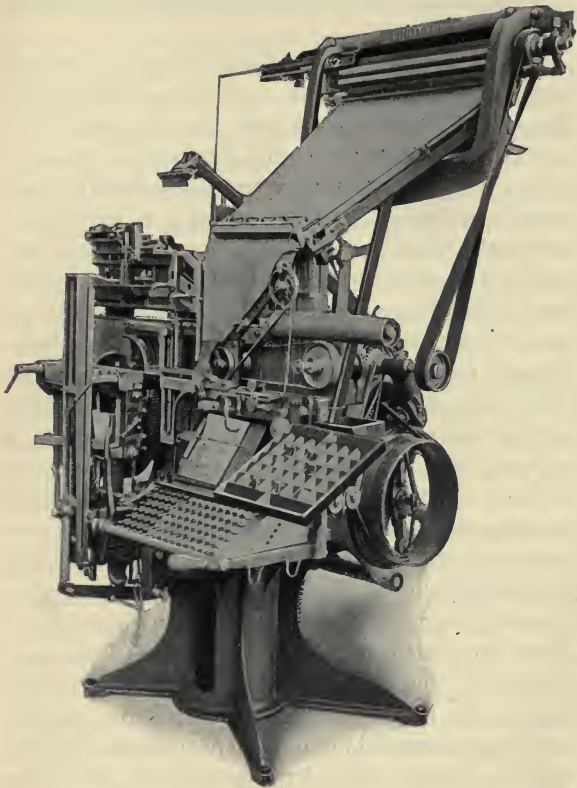

FIG. 1.

success because of its extreme complexity and consequent high cost.

The Cox machine, exhibited about 1899, was adapted to compose and justify the matter automatically. Corrugated spaces were inserted in the line during composition; the line was set to an excessive length, and justification was secured by compressing it endwise, the effect being to flatten and reduce the thickness of the spaces. The spaces were removed from the dead matter by a special machine, after which the matter was transferred to a third machine, by which the type was distributed into tubes adapted for application to the composing-machine.

The Simplex machine, of which a considerable number are used in the United States, consists of an upright rotary barrel or magazine having vertical grooves to carry the types, which are delivered by means of keys from the lower ends of the grooves to a revolving disk, by which they are assembled in a continuous line. This line, advancing through a suitable guide, is divided by hand into shorter lines, which are justified by hand, as usual. The upper portion of the grooved barrel revolves intermittently; the lines of the dead matter are inserted into its grooves and are carried around step by step over the upper ends of the grooves in the lower part of the barrel. These lower grooves have at the upper end small teeth arranged in various combinations corresponding to the nicks in the various types, so that the types stowed above in the upper

revolving cylinder are permitted to enter only those grooves which have teeth corresponding to their nicks. In this manner each letter is delivered to its proper groove.

In the Empire and other machines the types, carried in vertical magazines, are released at the lower end by finger-keys. They slide down through converging grooves to the assembling-point, where they are assembled or composed in a continuous unjustified line. This line is divided into shorter lengths by hand and justified as in hand-composition. The distribution into the magazines to be used on the composing mechanism is effected in a separate machine in which the nicked types are carried successively past a series of small slides, or feelers, coöperating with the nicks to deliver the types to their appropriate channels.

In the McMillan machine the types, carried in separate tubes, were automatically composed with tentative spaces into lines of approximately the required measure. The original spaces were automatically rejected in succession and thicker spaces inserted until the line was the required length. Distribution was effected by an independent rotary machine which delivered the type into single tubes, one for each letter, these tubes being subsequently transferred when full to the composing-machine.

Another class of machines was designed to cast each character singly and assemble them in line, in the order in which they were to appear in print.

A machine of this class, by C. S. Westcott, exhibited at the Centennial Exposition of 1876, cast and delivered the type in unjustified lines, justification being subsequently effected by hand. In this machine the finger-keys representing the letters caused the corresponding matrices to be transferred to the mould which was automatically adjusted to coöperate with the matrix and produce each letter of the required size.

The Lanston mechanism consists of two parts: first, an independent keyboard by which a paper ribbon is provided with perforations representing the various characters and spaces; the justifying perforations being made by touching the keys indicated to the operator by a scale which automatically calculates the size of spaces necessary to justify the line: second, a casting mechanism, controlled in its action by the perforated ribbon and serving to cast and assemble individual letters in the required order, and also to cast and insert in each line the spaces to effect justification. The casting operation is performed in the reverse order from that in which the matter is to be read.

The Johnson Tachytype and the Goodson Graphotype are machines on the general plan of the Lanston, being controlled by perforated paper ribbons and acting to cast the spaces and the type in the required order.

The last three machines are based on the use of the group of matrices representing the various

characters in connection with an adjustable mould similar to that of the type-founding machines. The matrices are automatically moved, so that each letter is presented to the mould, and the mould adjusted for a body of corresponding size.

THE MERGENTHALER LINOTYPE

The Mergenthaler Linotype machine, a modern example of which is shown in Figure 1, appeared in crude form about 1886. This machine differs widely



FIG. 2.

from all others in that it is adapted to produce the type-faces for each line properly justified on the edge of a solid slug or linotype (shown in Figure 2).

These slugs, automatically produced and assembled by the machine, are used in the same manner as other type-forms, whether for direct printing or for electrotyping, and are remelted after use.

GENERAL ORGANIZATION

The general organization of the machine will first be described, after which the details will be more

fully explained, and attention plainly directed to the various parts and actions which require special consideration.

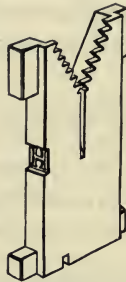

FIG. 3.

The machine contains, as the vital element, about sixteen hundred matrices, such as are shown in Figure 3, each consisting of a small brass plate having in one edge the female character or matrix proper, and in the upper end a series of teeth, used as hereinafter explained for distributing the matrices after use to their proper places in the magazine of the machine. There are in the machine a number of matrices for each letter and also matrices representing special characters, and spaces or quadrats of different thicknesses for use in table-work, etc. There is a series of finger keys representing the various characters and spaces, and the machine is so organized that on manipulating the keys it selects the matrices in the order in which their characters are to appear in print, and assembles them

in a line, as shown in Figure 4, with wedge-shaped spaces or justifiers between the words. The series of matrices thus assembled in line forms a line matrix, or, in other words, a line of female dies adapted

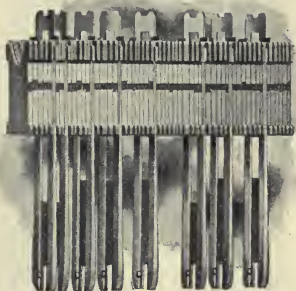

FIG. 4.

to mould or form a line of raised type on a slug cast against the matrices. After the matrix line is composed it is automatically transferred to the face of a slotted mould into which molten type-metal is delivered to form a slug or linotype against the matrices. This done, the matrices are returned to the magazine and distributed, to be again composed in new relations for succeeding lines.

Figure 5 illustrates the general organization of the machine.

A represents an inclined channelled magazine in which the matrices are stored. Each channel has at the lower end an escapement *B* to release the matrices one at a time. Each of these escapements is

406 *General organization of machine*

connected by a rod *C* and intermediate devices to one of the finger-keys in the keyboard *D*. These

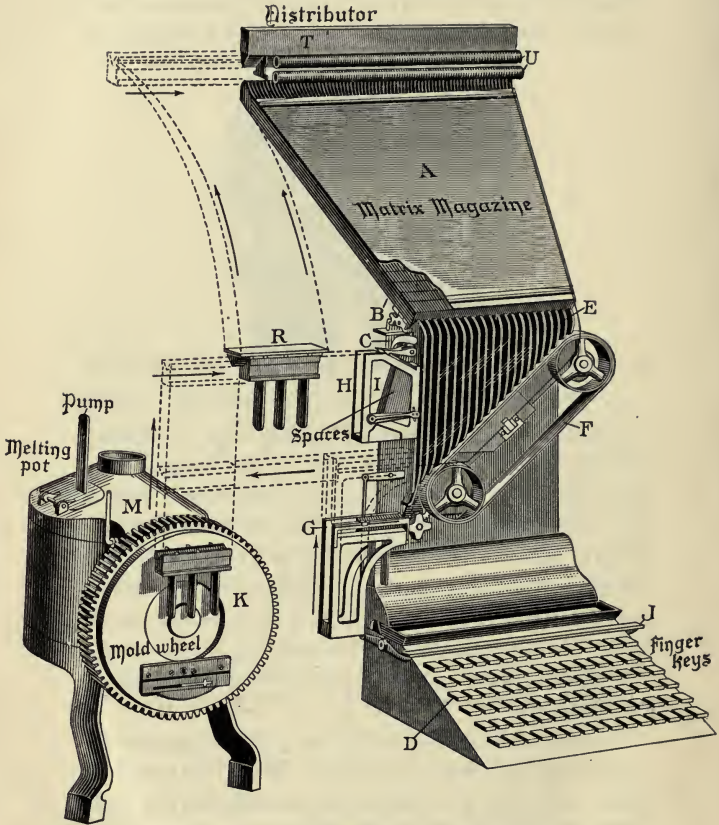

FIG. 5.

keys represent the various characters as in a typewriter. The keys are depressed in the order in which the characters and spaces are to appear, and the matrices, released successively from the lower end of the magazine, descend between the guides *E* to the surface of an inclined travelling belt *F*, by which they are carried downward and delivered successively into a channel in the upper part of the assembling elevator *G*, in which they are advanced by a star-shaped wheel, seen at the right.

The wedge-shaped spaces or justifiers *I* are held in a magazine *H*, from which they are delivered at proper intervals by finger-key *J* in the keyboard, so that they may pass downward and assume their proper positions in the line of matrices.

When the composition of the line is completed, the assembling elevator *G* is raised and the line is transferred, as indicated by dotted lines, first to the left and then downward to the casting position in front of the slotted mould seated in and extending through the vertical wheel *K*, as shown in Figures 5 and 6. The line of matrices is pressed against and closes the front of the mould, the characters on the matrices standing directly opposite the slot in the mould, as shown. The back of the mould communicates with and is closed by the mouth of a melting-pot *M*, containing a supply of molten metal and heated by a Bunsen burner thereunder. Within the pot is a vertical pump-plunger which acts at the

proper time to drive the molten metal through the perforated mouth of the pot into the mould and into

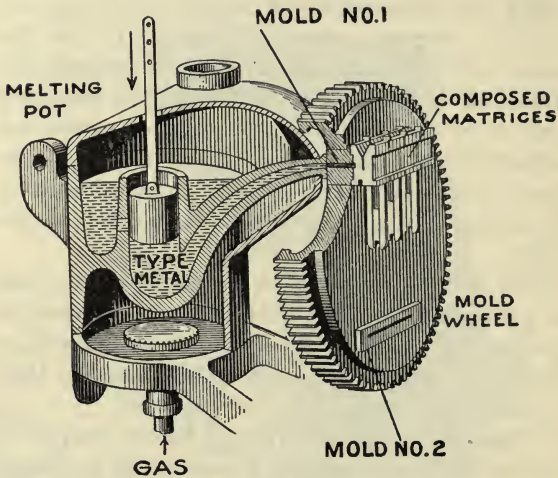
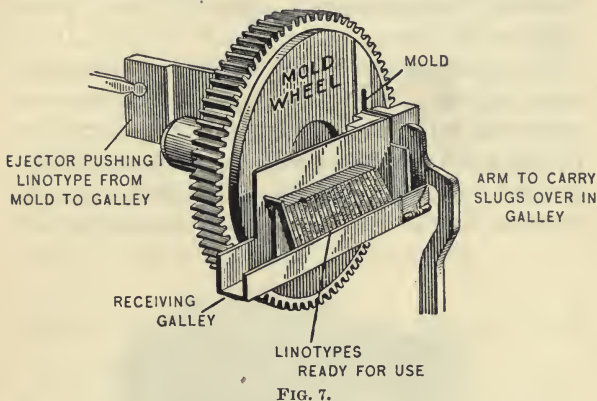

FIG. 6.

all the characters in the matrices. The metal, solidifying, forms a slug or linotype bearing on its edge, in relief, type-characters produced from the matrices. The matrices and the pot are immediately separated from the mould, and the mould wheel rotates until the slug contained in the mould is presented in front of an ejector blade, where the slug is ejected from the mould through a pair of knives, which trim the sides to the required size, into the receiving galley, as shown in Figure 7.

After the line of matrices and spaces has served

its purpose, it is raised from the casting position and moved to the right, as shown by the dotted lines and arrows in Figure 5. The teeth in the



upper ends of the matrices are engaged with a toothed bar *R*, known as the second elevator. This elevator swings upward, as shown by dotted lines, carrying the matrices to the level of the upper end of the magazine, and leaving the spaces or justifiers behind to be transferred to their magazine *H*.

The distributing mechanism consists essentially of a fixed bar *T*, lying in a horizontal position above the upper end of the magazine, and having along its lower edge, as shown in Figures 5 and 8, horizontal teeth to engage the teeth in the upper end of the matrices and hold them in suspension. The teeth of the matrix for each letter differ in number

or arrangement, or both, from the teeth of matrices bearing other letters, and the teeth on the lower edge of the distributor bar are correspondingly varied in arrangement at different points in the length of the bar.

The matrices are moved forward into engagement with the distributor bar and also into engagement with the threads of horizontal screws *U*, which are extended parallel with the distributor bar and constantly rotated, so that they cause the matrices to travel one after another along the dis-

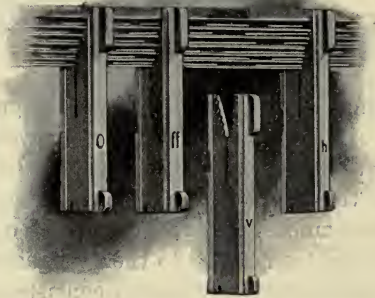

FIG. 8.

tributor and over the mouths of the channels in the magazines. Each matrix is held in suspension until it arrives over its proper channel, where for the first time its teeth bear such relation to those

of the bar that it is released and permitted to fall into the magazine, as shown in Figure 8.

The speed of the machine, which is commonly from four to five thousand ems per hour, but which has reached ten thousand and upward in competitive trials, is due to the fact that the matrices pursue a circulatory course, leaving the magazine at the lower end, passing thence to the line and to the casting mechanism, and finally returning to the top of the magazine. This permits the composition of one line, the casting of another, and the distribution of a third to proceed simultaneously.

ASSEMBLING AND KEYBOARD MECHANISMS

The matrices pass through the magazine by gravity. Their release is effected by mechanisms shown in Figures 9 and 10, which are vertical sections through the magazine, the keyboard and intermediate connections. Under each channel of the magazine there is an escapement *B*, consisting of a small lever rocking at its centre on a horizontal pivot, and carrying at its opposite ends two dogs or pawls *b*, *b*, which are projected up alternately into the magazine by the motion of the lever. The key-rod *C*, suspended from the rear end of the escapement *B*, tends to hold the lower pawl *b* in an elevated position, as shown in Figure 9, so that it engages under the upper ear of the foremost matrix to prevent its escape.

412 *Figure showing vertical section*

When the escapement *B* is rocked it withdraws the lower pawl *b*, as shown in Figure 10, at the same

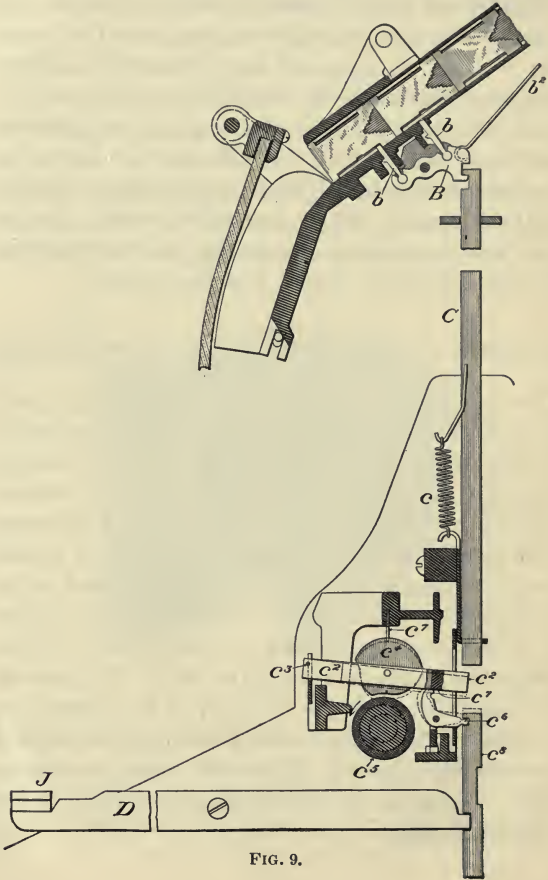

FIG. 9.

time raising the upper pawl, so that it engages and momentarily arrests the next matrix. As soon as

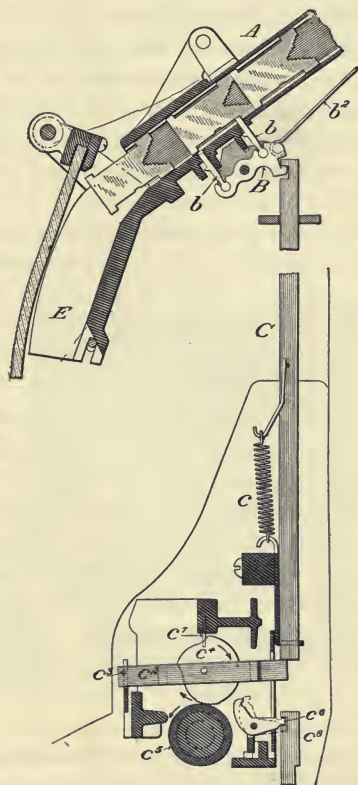

FIG. 10.

the first matrix has escaped, the escapement resumes its original position, the upper pawl falling,

while the lower one rises so as to hold the second matrix, which assumes the position previously occupied by the one released.

Thus it is that the alternate rising and falling of the two escapement pawls permits the matrices to escape one at a time. It is evident that the escapements could be operated directly by rods connected with the finger-keys, but this direct connection is objectionable because of the labor required on the part of the operator, and the danger that the keys may not be fully depressed. Moreover, it is essential that the escapements should act individually with moderate speed to the end that the matrices may be properly engaged and disengaged by the pawls. For these reasons, and to secure easy and uniform action of the parts, the mechanism shown in Figures 9 and 10 is introduced between the finger-keys and escapements. The vertical rods C , which actuate the escapements, are guided in the main frame and each urged downward by a spring c . Each rod C terminates directly over one end of a rising and falling yoke-bar c^2 , turning on a pivot c^3 at the opposite end. Each of the yokes c^2 is slotted vertically to admit an eccentric c^4 turning on a pivot therein. A constantly rotating rubber-covered roll c^5 is extended across the entire keyboard beneath the cams, which stand normally as shown in Figure 9, out of contact with the roll. When the parts are in this position, the cam-yoke is sustained at its free end by the yoke-trigger c^6 , and a

cross-bar in the cam engages a vertical pin c^7 on the frame, whereby the cam is prevented from falling on to the roller, as it has a tendency to do. Each of the yoke-triggers c^6 is connected with a vertical bar c^8 , which is in turn connected to the rear end of a finger-key lever D . The parts stand normally at rest in the position shown in Figure 9, the roll c^5 turning freely under the cam without effect thereon.

When the finger-key is depressed it raises the bar c^8 , which in turn trips the yoke-trigger c^6 from

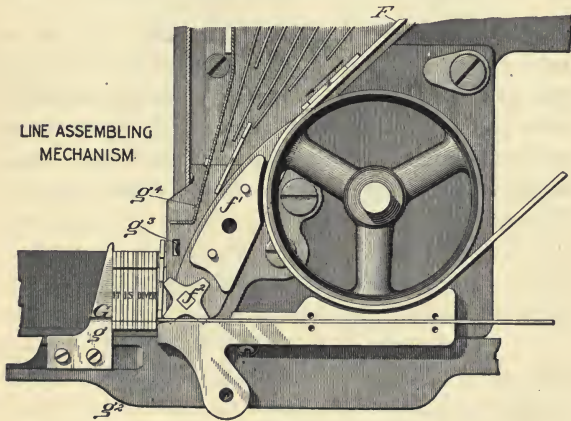

FIG. 11.

under the cam-yoke c^2 , permitting the latter to fall, thereby lowering the cam c^4 into peripheral engagement with the rubber roll, at the same time disengaging the cam from the stop-pin c^7 . The roll,

engaging frictionally with the cam, causes the latter to turn on its centre in the direction indicated by the arrow in Figure 10.

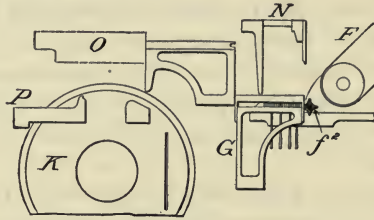

FIG. 12.

Owing to the eccentric shape of the cam, its rotation while resting on the roller causes it to lift the yoke c^2 above its original position, so that it acts upon the escapement rod C , lifting the same and causing it to reverse the position of the escapement B , to release the matrix, as plainly seen in Figure 10.

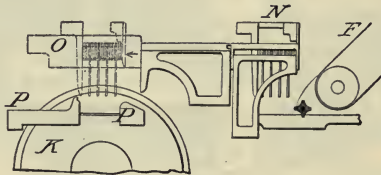

FIG. 13.

While this is taking place the yoke-trigger c^6 resumes its first position, as shown in dotted lines in Figure 10, so that as the rotating cam lowers the yoke, it is again supported in its first position, the

cam at the same time turning forward by momentum out of engagement with the roll and until arrested in its original position by the pin e^7 .

It will be observed that the parts between each key lever and escapement operate independently of the others, so that a number of cams may be in engagement with the rollers at one time, and a

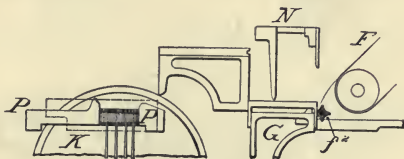

FIG. 14.

number of escapements at different stages of their action at one time.

The matrices falling from the magazine descend through the front channels and are received on the inclined belt F , on which they are carried over and guided on the upper rounding surface of the assembler entrance-block f^1 , by which they are guided downward in front of the star-wheel f^2 , which pushes them forward one after another.

The spaces or justifiers I , released from their magazine H , as heretofore described, descend into the assembler G in front of the star-wheel in the same manner as the matrices.

The line in course of composition is sustained at its front end by a yielding finger or resistant g , secured to a horizontal assembler slide g^2 , the purpose

of these parts being to hold the line together in compact form.

As the matrices approach the line, their upper ends are carried over a spring g^3 , projecting through

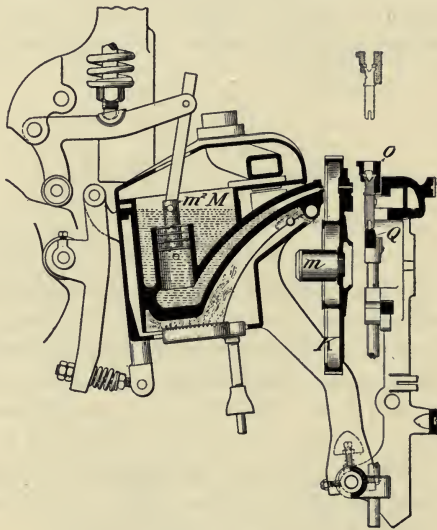

FIG. 15.

the assembler face-plate from the rear, as shown in Figure 11, its purpose being to hold the matrices forward and prevent them from falling back in such a manner that succeeding matrices and spaces or justifiers will pass improperly ahead of them. The descending matrices also pass beneath a long de-

pending spring g^4 , which should be so adjusted as barely to permit the passage of the thickest matrix.

After the composition of the line is completed in the assembling elevator G , as shown in Figure 12,

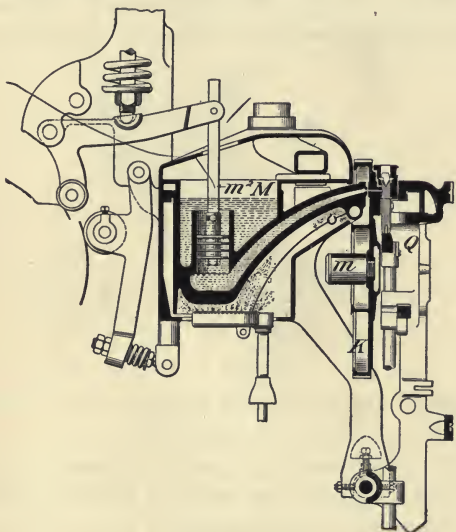

FIG. 16.

the elevator is raised as shown in Figure 13, so as to present the line between the depending fingers of the transfer-carriage N , which then moves to the left to the position shown by dotted lines in Figure 13, thereby bringing the line into the first elevator O , which then descends, carrying the line of matrices downward, as shown in Figure 14, to its

position in front of the mould and between the confining jaws *P, P*, mounted in the main frame, which determine the length of the line.

Figures 15 and 16 show the casting mechanism in vertical section from front to rear. When the first elevator *O* lowers the line, as just described,

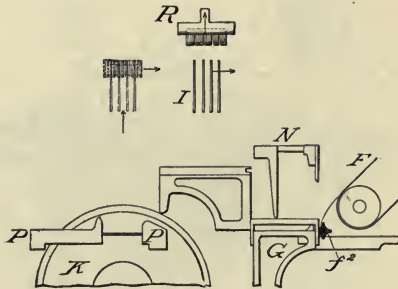

FIG. 17.

the mould and the pot *M* stand in their rearward positions, as shown in Figure 15.

The mould-carrying wheel is sustained by a horizontal slide, and as soon as the matrix line is lowered to the casting position, a cam at the rear pushes the slide and mould wheel forward until the front face of the mould is closed tightly against the rear face of the matrix line, as shown in Figure 16.

While this is taking place, the pot, having its supporting legs mounted on a horizontal shaft, swings forward until its mouth is closed tightly against the back of the mould, as shown in Figure 16. While the parts are in this position, the

justifying bar *Q* is driven up and pushes the spaces or justifiers upward through the line of matrices until the line is expanded or elongated to fill completely the gap between jaws *P*, *P*.

In order to secure exact alignment of the matrices vertically and horizontally, the bar *Q* acts

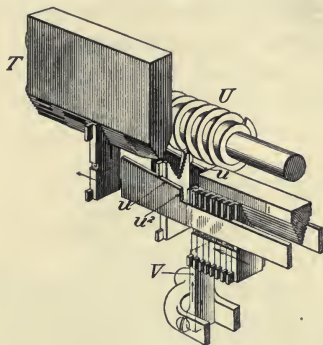

FIG. 18.

repeatedly on the spaces, and the line is slightly unlocked endwise and relocked. This is done that the matrices may be temporarily released to facilitate the accurate adjustment demanded. While the justified line is locked fast between the jaws, the elevator, and the mould, the plunger m^2 in the pot descends and drives the molten metal before it through the spout or mouth of the pot into the mould, which is filled under pressure, so that a solid slug is produced against the matrices. The pot then retreats, and its mouth breaks away from the

back of the slug in the mould, while, at the same time, the mould retreats to draw the type-characters on the contained slug out of the matrices. The mould wheel now revolves, carrying the rear edge of the slug past a stationary trimming-knife, not shown, and around to the position in front of the ejector, as previously described and shown in Figure 7, whereupon the ejector advances and drives the slug between two side trimming-knives into the galley at the front.

DISTRIBUTION

After the casting action the first elevator *O* rises and carries the matrix line above the original or composing level, as shown in Figure 17. The line is then drawn horizontally to the right until the teeth of the matrices engage the toothed elevator bar *R*, which swings upward with the matrices, thus separating the matrices from the spaces or justifiers *I*, which remain suspended in the frame, so that they may be pushed to the right, as indicated by the arrow, into their magazine.

When the line of matrices is raised to the distributor, it is necessary that the matrices shall be separated and presented one at a time to the distributor bar, between the threads of the horizontal carrier-screws. This is accomplished as shown in Figures 18 and 19. A horizontal pusher or line-shifter *S* carries the line of matrices forward from

the elevator bar *R* into the so-called distributor box, containing at its opposite sides two rails *u*, having near their forward ends shoulders u^2 , against which the forward matrix abuts so as to prevent further advance of the line, which is urged constantly forward by the follower or line-shifter *S*. A vertically reciprocating lifting finger *V* has its upper end shouldered to engage beneath the foremost matrix, so as to push the same upward until its upper ears are lifted above the detaining shoulders u^2 , so that they may ride forward on the up-

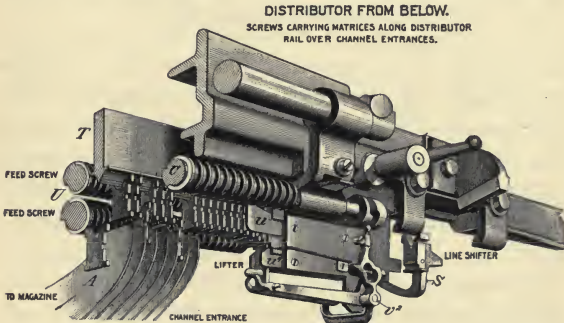

FIG. 19.

wardly inclined inner ends of the rails, as shown in Figure 18. The matrices thus lifted are engaged by the screws and carried forward, and as they move forward they are gradually raised by the rails until the teeth finally engage themselves on the distributor bar *T*, from which they are suspended as they are carried forward over the mouth of the

magazine, until they fall into their respective channels, as shown in Figure 19.

The distributor box also contains on opposite sides shorter rails, u^4 , adapted to engage the lower ends of the matrices, to hold them in position as they are lifted. The lifting finger V is mounted on a horizontal pivot in one end of an elbow lever mounted on pivot v^2 and actuated by a cam on the end of one of the carrier-screws, as shown in Figures 5, 8, and 19.

TRIMMING-KNIVES

In practice there is occasionally found a slight irregularity in the thickness of slugs, and thin fins are sometimes cast around the forward edges. For the purpose of reducing them to a uniform thickness, they are driven on their way to the galley between two vertical knives, as shown in Figures 7 and 23. The inner knife is stationary, but the outer knife is adjustable in order that it may accommodate slugs of different thicknesses. This adjustment is made by the knife being seated at its outer edge against a supporting bar or wedge, having at opposite ends two inclined surfaces seated against supporting screws in the knife-block. A lever engages a pin on the wedge for the purpose of moving it endwise; when moving in one direction, it forces the knife inward toward the stationary knife, and when moved in the other direction it

forces it to retreat under the influence of a spring seated in the block. The wedge is provided with a series of teeth engaged by a spring-actuated pin or dog, whereby the wedge and the knife are stopped in proper positions to insure the exact space required between the two knives.

The back knife, secured to the frame for trimming the base of the slug as it is carried past by the revolving wheel, should be kept moderately sharp and adjusted so as to fit closely against the back of the passing mould. Particular attention should be paid to this feature. The edge of the knife must bear uniformly across the face of the mould.

The front knives, between which the slug is ejected, should not be made too sharp. After being sharpened, the thin edge can be advantageously removed by the use of a thin oilstone applied against the side face; that is, against the face past which the slug is carried.

The stationary or left-hand knife should be so adjusted as to align exactly with the inner side of the mould. Under proper conditions this knife does not trim the side face of the slug, but acts only to remove any slight fins or projections at the front edge.

The right-hand knife, adjustable by means of a wedge and lever, should stand exactly parallel with the stationary knife. It trims the side of the slug on which the ribs are formed, and it serves to bring the slug to the exact thickness required.

LEARNING TO OPERATE

It is of first importance that the operator should learn to finger the keys with a soft and speedy touch. The key should be instantly released and the finger carried to the next with a gliding movement. A violent or very forcible depression of the key is objectionable; it prevents high speed and impairs the action of the mechanism. As the keys simply act to release the power-driven devices, nothing is gained by a violent stroke. The very speedy operators are, almost without exception, those who finger the keys swiftly and at a uniform rate of speed. Anything in the nature of a spasmodic action, or of a rapid operation of several keys followed by a pause and a repetition of the first action, is to be avoided. High speed is not to be expected in the first few weeks. The operator is advised to study his board carefully and to select and finger the keys slowly and deliberately, in order that he may acquire the proper touch and the best distribution of work between the two hands. The best position at the machine is to have the centre line of the body nearly opposite the lower-case m, as most of the work is done at the left end of the keyboard. The first and second fingers of both hands are generally used, and the thumbs and other fingers occasionally. The keys in the first two rows should be fingered mainly by the left

hand, which should leave them only when the right hand is reaching for distant capital letters. The space-bar can be advantageously operated by the little finger. Where the same letter is to be used twice in succession, a slight dwell on the key, readily acquired, will secure the result. Wherever succeeding letters are represented on adjacent keys, much time is saved by a gliding or wiping action of the finger from one key to another. If the letters of a word are far apart on the keyboard, they are to be struck in quick succession, one with each hand. The beginner should first learn the location of the keys, then study the manner of reaching them with the least movement of the hand, and after this has been accomplished, and not before, should he attempt to increase his speed. In a short time he will unconsciously memorize the location of all the keys, and the action of the hands will be as automatic as in writing.¹

MANAGEMENT OF THE MACHINE

The first thing of importance in the use of the machine is the employment of a good linotype metal. Unless a proper metal is employed, and unless, as in stereotyping, the metal is kept in proper condition, it will be impossible to secure good results. The metal is to be composed of pure

¹ For additional remarks on this subject see Correct Keyboard Fingering, on pages 447-459 of this chapter.

lead, tin, and antimony, in proportions known to the experts. From repeated use the metal is slowly oxidized and dross appears. This dross should be skimmed off and removed at reasonable intervals, and when the metal becomes hard or brittle a small percentage of tin should be added to increase its fluidity and the sharpness of the type-faces. Specially prepared alloys for doctoring or restoring the metal may be obtained from nearly all dealers in supplies. When the metal becomes exceedingly foul or brittle, or is in such condition that it does not melt and flow readily, it may be purified by melting it in a suitable pot and immersing in the molten metal a stick of green wood. This should be submerged in the metal and permitted to remain about twenty minutes, or until the boiling ceases. The remains of the wood should be removed and the metal thoroughly stirred and skimmed. The addition of a few ounces of rosin to the molten metal before the introduction of the wood is recommended.

TEMPERATURE OF METAL

It is important that the temperature of the metal in the melting-pot shall not materially exceed 550° Fahrenheit. The temperature can be readily tested by one of the special iron-clad thermometers made for the purpose, or by thrusting into the pot a sheet of paper, which at the proper temperature should slowly assume a brown color without burning

or smoking. If the temperature is raised above the proper point, the metal is speedily impaired, the slugs are caused to adhere tightly in the mould, so that ejection is difficult, the bodies of the slugs are rendered porous, and the matrices are injured.

The temperature is controlled by regulating the mercurial governor at the side of the pot. As the column of mercury expands with the increasing heat of the pot, it rises in the glass tube and checks the flow of gas to the burner. The height of the mercury is adjusted by means of a small stem or spindle in the side of the governor. When the thermometer shows that the metal is at the proper temperature, the mercury should be at the foot of the small central gas-tube. If too high or too low, adjust the spindle to bring it to the proper level.

The pressure of the gas received from city mains varies widely at different hours of the day and night. Each machine plant is therefore provided with a pressure governor or regulator. These governors, for use on the main supply-pipe, contain a diaphragm or float, which may be loaded to a greater or less extent. The load should be regulated so that the governor will permit the flow of gas at moderate pressure only.

TREATMENT OF MATRICES

The perfection of the type-characters produced depends wholly on the condition of the matrices,

which are made with great precision and require to be intelligently and carefully treated.

It is of importance that the side faces of the matrices shall be kept clean and free from foreign matter, in order that they may be locked tightly together in the line, and to prevent the molten metal from flowing between them.

They should be removed from the machine when necessary and carefully rubbed on their side faces on a soft pine board, a sheet of canvas, or like material, taking care not to rub them so hard as to round the corners. They should never be washed in benzine unless unusually foul. The use of a very slight amount of finely pulverized graphite is of advantage, but care should be taken to avoid using it in excessive quantity. A minute amount applied in the magazine or on the matrices will be slowly distributed, and in the course of a few days will give burnished surfaces. The continued use of the matrices causes a fine film or oxide to be formed in the characters, so that the metal may be cast freely and sharply into them and the type-characters easily withdrawn.

Under no circumstances should the matrices be thrown loosely into boxes or tumbled together. The result will be to crush or break in the very thin side walls of the characters, and it is this breaking down of the walls, so that metal may flow between the matrices, which causes fins or hair-lines on the slugs.

TREATMENT OF SPACES OR JUSTIFIERS

As previously mentioned, the spaces or justifiers consist of a short wedge and a longer wedge having a sliding connection therewith. The short wedges are held fast in the line, so that they present always the same point at the casting level. The molten



FIG. 20.

type-metal therefore tends to accumulate on the side of the short wedges or sleeves and to build up projections, as shown in Figure 20, so that when

a space is locked up in a line of matrices, the projection will crush in the side wall of the adjoining matrix. This metal should be removed daily. It cannot be wiped off. It should be carefully scaled or peeled off with the edge of a knife-blade or similar instrument, taking care not to scratch the wedge. After removing all the metal, the side face of the wedge should be rubbed on the surface of a board, or like material, coated with graphite or hard soap. Graphite may be sprinkled on felt firmly tacked to a board. The spaces or justifiers must not under any circumstances be rubbed on emery-cloth, filed, or treated in any other manner which will remove the corners or round the faces. They must be left flat and true, as originally made.

CLEANING MACHINES

Cleanliness is the one thing which, more than all others, will contribute to the speed and endurance of the machine and the excellence of its product. Every running or wearing part of the machine should have its surfaces carefully wiped clean at short intervals, and all surfaces excepting those with which matrices contact should be moderately oiled. Under no circumstances should oil be applied within the magazine or to any of the surfaces against which the matrices travel.

The attendant should go carefully over his machine at short intervals, see that all oil-holes are

clear, and supply them to a reasonable extent with lubricating oil of good quality.

Special care should be taken to see that the pivots of the rolls which travel on the large cams at the rear of the machine are oiled, so that the rolls will turn freely. Watch particularly the roll behind the melting-pot, which, becoming heated, is more liable than others to become fast on its pivot. The small brass cams of the keyboard above the rubber rolls should be watched. From time to time the dust and dirt should be brushed out of the keyboard, and a very small amount of watch-oil applied with a broom straw, or like means, to the cam-pivots. The journals of the distributor screws should also be watched and lubricated from time to time, but particular care must be observed at this point to limit the amount of oil so that it will not flow out on to the adjoining parts and reach the matrices or get into the magazine.

THE MELTING-POT

The melting-pot of the machine should be kept free from dross. A hard oxide of lead and antimony will sometimes form in the throat of the pot and obstruct the discharge of the metal. It is very important that the operator should at reasonable intervals remove the mouthpiece and see that the throat is clear. The mouthpiece of the pot should always close tightly against the back of the mould.

The two surfaces should be watched carefully, and any metal or other foreign-matter removed, taking care not to use emery-paper or any other material or instrument which will scratch the surface of the mould.

Occasionally the mouth of the pot will become slightly warped, so that there will be leakage of metal between the mould and the pot mouth. In such case the back of the mould should be inked and the mouthpiece closed against it. The ink will be transferred to the high points on the mouthpiece, which must be carefully dressed down with a fine file until it is perfectly flat, so that there will be contact over its whole surface with the mould. Take off but little at a time, and keep the face of the file square with the mouthpiece.

The holes in the pot mouth should be exposed fully to the mould cell and show full and round on the bottom of the slug. The adjusting screws in the lower ends of the pot legs are for the purpose of raising, lowering, and tipping the pot, so that the holes may be brought into proper relation with the mould. Attention should be paid to the spring at the back of the pot, through which it is pressed forward against the mould. The spring should have such tension as to carry the pot tightly against the mould, but excessive pressure should be avoided because of the needless wear on the parts and the increased power that would be required to drive the machine.

THE MOULD

The mould should be kept scrupulously clean on both the front and rear faces and in the interior. It should be secured tightly to the carrying disk or wheel. If at any time it presents any roughness, it should be very carefully and skilfully burnished. Neither files nor emery-paper should be used. If the corners or surfaces are rounded in the slightest, there will be leakage of metal and imperfect slugs.

The mould should be taken apart occasionally, and the mould cell cleaned and polished, and the trimming-knives set properly. This will permit the slugs to be ejected easily.

The ejector blade is guided on one side by the slide which carries the mould wheel, and on the opposite side by a cushioned ejector support to guide the blades of different thicknesses and keep them straight and in line with the mould. Care should be taken to see that the ejector is always accurately and closely guided, so that it will be certain to enter the mould without striking the corner of the latter. Carelessness in this respect will lead to fatal injury to the mould, the corners of which must remain absolutely sharp and square.

THE MOULD DISK

The disk in which the mould is carried should be carefully watched to see that it runs true, and the

slide in which it is carried should have its wearing surfaces occasionally oiled. The guides in which the slide moves should be watched. They will sometimes wear and allow the mould wheel and mould to fall below the proper level. Adjustment screws are provided for raising the guides when this occurs.

The mould disk turns intermittingly, and when in the casting position and in the position for the ejection of the slug, it moves forward over stop-pins or studs on the frame. These pins enter removable bushings in the disk, and they should fit snugly therein, so that there may be no rotary motion of the disk in either direction. This is very important, in order that the mould may align exactly with the pot and with the trimming-knives, between which the slug is driven. The holes in the bushings become worn and elongated in time. The operator should examine them from time to time, and whenever they are worn the bushings should be unscrewed and new ones substituted.

Occasionally the mould disk will fail to stop in the proper position. This is due to the wearing away of the square hub on the rear end of the mould-turning shaft. This square hub bears against the side face of the adjoining cam. The cam contains, at the point of bearing, a hardened steel plate, which may be adjusted inward and outward, to compensate for the wear of the hub. If the hub is seriously worn it should be removed and replaced by another.

THE ASSEMBLING ELEVATOR

The assembling elevator, in which the matrices are composed, will sometimes wear at the point where the matrices and spaces enter and strike. In the modern machines there are removable plates at this point. When worn, they should be replaced by others. If the assembler is of the solid type, without removable plates, a new elevator may be necessary. The pawls or dogs at the entrance to the elevator should be examined from time to time to see that they engage the edges of the incoming matrices, so as to prevent them from falling to the right.

Transposition of matrices in the line will sometimes occur. This is usually due to the failure of the small spring g^3 (Figure 11) which projects through the assembler throat from the back, immediately above the star-wheel. This spring should project forward sufficiently to catch each matrix as it passes and hold it forward in position to enter the line. Above the star-wheel, between the passage for the spaces or justifiers and the path of the down-coming matrices, there is a long pendent spring. The lower end of this spring should be in such position that there will be just sufficient room beneath it for the passage of the thickest matrix in the font.

When the assembling elevator rises, its matrix-supporting shoulders should align exactly with the shoulders in the stationary line-delivery channel,

through which the matrix line is transferred to the left, to the first elevator. If the parts do not align, attention should be given to the adjusting screws.

THE FIRST ELEVATOR

The first elevator, to which the composed line is transferred, serves first to lower the line to the mould or casting position, and thereafter to lift it above the original level, so that the line may be transferred to the right preparatory to the separation of the spaces or justifiers from matrices and the further elevation of the latter to the distributor by the second elevator. The jaws of the first elevator should be carefully watched to see that they are not mutilated and that they are parallel and at such distance apart as to permit the free movement of the matrices between them. The pawls at the open end of these jaws should also be carefully noticed to see that they are in operative position and that they retain the incoming matrices with certainty. It is of vital importance that the first elevator shall carry the matrix line downward until the ears at the lower ends of the matrices are in position to permit the mould to slide forward freely over them.

The descent of the elevator is controlled by a screw in its top which bears upon the top of the vise frame. If the elevator is stopped at a high level, and through any cause the vise automatic fails to work, the sharp corner of the mould, advancing

over the ears, will shave away their upper edges, with the result of destroying the matrices and the alignment of the type-characters on the slugs.

When the assembling elevator rises to its upper position, it is very important that it should align horizontally with the channel into which the matrices are transferred to engage the second elevator. An adjusting screw at the lower end of the elevator slide serves to give it the required position. This elevator is raised and lowered by the large cam on the outside of the frame, which acts on a roller on the end of the lever. It will be observed there is also an adjustment between the two parts of this lever, outside of the frame and near the cam, to change the vertical movement of the elevator.

THE SECOND ELEVATOR

The second elevator, to which the line of matrices is transferred from the first elevator, carries a toothed or ribbed bar to engage and lift the matrices. This bar should be watched to see that its teeth are not rough or mutilated. Either of these defects will cause the bar to wear or to cut away the teeth of the matrices and cause bad distribution.

When the second elevator lifts the matrices to the top of the machine, it comes to a rest against a solid support or banking-piece. These parts should be kept scrupulously clean and should be watched to see that the toothed bar carrying the matrices

comes into exact alignment with the corresponding bar in the lift-box of the distributor, so that the matrices may be pushed forward smoothly from one bar to the other and into the box.

The slide which pushes the matrix line forward from the second elevator should move freely, and its actuating spring should be adjusted so that it will force the line horizontally with moderate pressure. The forward matrix of the line will bear against the vertical shoulders of the rails in the box, as detailed on page 423, and the matrix will be held in position directly over the upper end of the vertical lifting finger. This finger will push the matrix upward, clear of the shoulders and in engagement with the feed-screws. The matrix will thus be carried along with its shoulders riding on the inclined ends of the rails, until it is lifted into engagement with the teeth of the distributor bar, along which it will be carried. The rising matrices will gradually wear away the vertical shoulders of the stop-rails in the box, so that the matrices will be lifted to an improper position and against the threads of the screws, by which they will be bent. The rails should therefore be carefully watched, and when appreciably worn they should be replaced by new rails.

In the later machines the shoulders of the rails are made in separate pieces, so that they may be removed and replaced by others without renewing the entire rails.

The distributor box may be removed by releasing the one large screw. When the box is restored to its position, care should be observed to force it upward as far as it will go and until it is seated firmly in place. Failure to do this will result in damage to matrices.

The matrix-lifting finger also requires attention. It should be so adjusted that it will in every case lift the matrix clear of the shoulders on the side

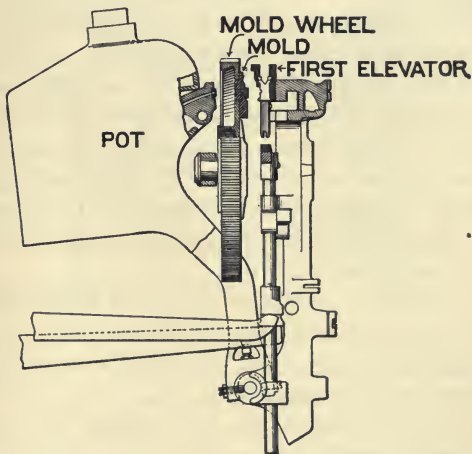

FIG. 21.

rails, but should not be permitted to lift a matrix any farther than is necessary to secure its release.

The shoulder of the lifting finger on which the matrix bears should be kept clean. If dirt is permitted to accumulate in the angle, the finger will slip off from the matrices and fail to lift them properly.

In the distributor box the bar overlying the line of matrices is provided at the inner or front end with a thin vertical blade to enter the vertical slot in the centre of the front matrix. The object of this blade is to prevent the lifting of more than one matrix at a time. It will sometimes wear away on the end, or become shortened, so as to permit the lifting of two thin matrices. If two matrices are lifted at one time, it is due either to the wearing away of this blade, or to the wearing away of the stop-shoulders on the rails. They should be carefully examined to see that the space between them is such that only one matrix will pass upward. If the blade is too short, a new one should be inserted or new rails substituted.

The magazine channels should be brushed out from time to time and kept scrupulously clean. On this depends the free delivery that is needed for securing speedy composition.

The escapements at the lower end of the magazine should work freely at all times. Each pawl should sink until its upper end is exactly flush with the bottom of the groove or channel in which the matrix ears slide. At reasonable intervals the escapements should be thoroughly brushed out.

An exceedingly slight amount of fine graphite may be applied to the escapement levers to ease their action. Great care must be exercised not to apply an excessive amount. Time must be relied upon to secure its proper distribution.

The channels of the face-plate in front of the magazine should be kept clean, and great care should be taken to see that the upper ends of the

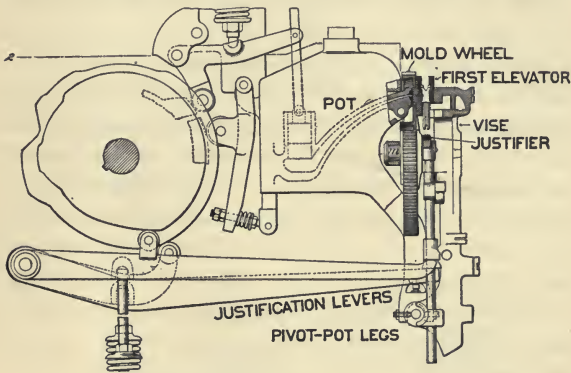

FIG. 22.

partitions do not overlap the ends of the matrices or the matrix channels, so as to obstruct the outcoming matrices.

In the older machines the lower end of the magazine is adjustable vertically and also laterally. If there is any failure to deliver matrices, the escapements should be carefully examined to see that the pawls rise and fall to the proper extent. If not,

the action can sometimes be corrected by slightly raising or lowering the end of the magazine.

The distributor bar should be kept very clean and in a burnished or polished condition. A piece of soft pine wood with a little black-lead is an excellent thing for this, as the soft wood cuts its way down to the bottom of the teeth of the bar and polishes it thoroughly. If from any cause the ends of its teeth become rough, it will speedily destroy the teeth of the matrices.

The channel entrance or magazine entrance below the distributor bar contains a series of vertical partitions, by which the matrices are guided downward into the upper flaring ends of the grooves or channels in the magazine. These partitions are sometimes bent to the right or left, so that the falling matrices will strike upon them or be deflected into the wrong channels. They should therefore be carefully watched in connection with the falling matrices to see that the latter enter freely between the partitions.

The distributor feed-screws should occupy proper relations to each other and to the bar. For this purpose one of the gear-wheels at the end has one of its teeth partly cut away and the companion gear is provided with a stud to enter the cavity. The back feed-screw can be raised by releasing the spring latch on right-hand end. When replacing, after the screw has been raised, care should be observed to reset the screws in the proper relation.

CAUTION

There are a few important errors against which operators are particularly cautioned.

Access is had to the casting mechanism by unlocking the vise frame and swinging it forward away from the mould. This should never be done unless the mould wheel is first moved rearward away from its stop-pins.

The machine should not be permitted to remain at rest with the pot against the mould. The effect will be to overheat the mould, soften it, and cause it to warp out of shape.

Spaces or justifiers should not be used at the extreme ends of a matrix line, nor should two be placed together in the line.

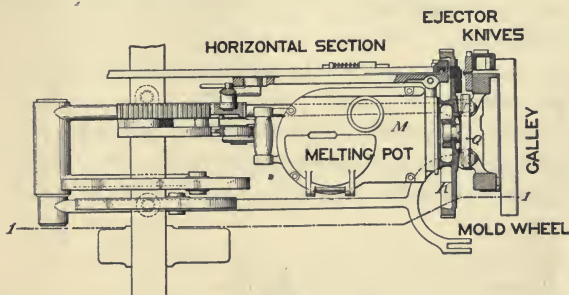

FIG. 23.

Under no circumstances should the magazine be pounded or subjected to harsh or violent treatment.

The matrix line should never be set to such length that it will fail to descend between the vise jaws easily. Under no circumstances should the first elevator be forced downward to carry a matrix line between the jaws. This action will cause displacement of the matrices, the bending of the jaws, and other serious evils which cannot be corrected except by a skilled mechanic.

The metal-pot should not be filled higher than half an inch from the top. The metal should never be permitted to run to a low level in the pot. Good results can be obtained only by filling the pot at short intervals, so as to maintain a substantially uniform level of the metal therein.

If the machine fails to run easily, it is because the parts are not clean and because they need oiling.

The tightening up of the main clutch, so as to drive the machine forcibly, is attended with many dangers.

No part of the machine should be filed or otherwise altered in shape.

If the parts fail to move easily, or fail to perform their functions, it is either because they are not clean, or because they are in need of adjustment.



CORRECT KEYBOARD FINGERING

That the average speed of operators of the Linotype is steadily increasing is undeniable. There are to-day divers ten-thousand-an-hour men. An operator nowadays is not designated as "swift" unless he can strike a seven- or eight-thousand-an-hour gait. What is it that is responsible for this noticeable increase in the operator's output in recent years? The machine itself has not undergone any material change. Indeed, ten thousand ems an hour has been averaged on the old-style square-base machine. It is not accountable on the assumption that the operators are becoming more proficient with practice. Many of the oldest operators are setting no more than they did in the first year or two on the machine. Some swift compositors failed to become fast operators, while many type-setters of mediocre ability at the case have developed into swifts on the keyboard. It has been witnessed time and again that a slow operator will suddenly blossom into a full-fledged swift, and the reason therefor is not apparent. What is the key to this mystery?

It is explainable only on the theory that these swifts have discovered some truths about operating the keyboard not universally known. They have devoted themselves to a painstaking study of the keyboard and its proper manipulation, and the

results are apparent in the records being hung up. What these few have done the many can do. It lies with themselves to make the effort. It is possible to set fifteen thousand ems an hour on the Linotype, and no operator should be content until he reaches the limit of his machine's capacity.

The first thought to occur to a student of this question is that to set type at such high rates of speed requires incessant reading of the copy. The keyboard must of necessity be operated without looking at it. Certainly one cannot be shifting the eyes to the keyboard and back to the copy without danger of losing one's place. Therefore it is apparent that, in order to avoid the necessity of looking at the keyboard, the location of the keys must be so fixed in the operator's mind that the fingers seek them mechanically, and the eyes be devoted to the continuous reading of the copy. If this is so, it no longer is necessary to read ahead of what one is setting, as was customary with the hand-compositor. To stop operating while memorizing a sentence is fatal to the acquirement of speed, which demands that the fingers be kept moving incessantly. The fingers travel over the keys as the eyes travel over the lines of the copy, the sense of what is being composed being kept by glancing ahead while sending up the line of matrices. Of course speed cannot be attained on illegible manuscript or unprepared copy of any description, but if no time is lost in fingering the

keys when the sailing is fair, the operator has time to decipher the cryptography of the scribbler while the elevator is "hung up." This is an important advantage fast operators have in keeping ahead of the machine. They actually lose no time when it is necessary to hand-space a line, make a correction, or study their copy, and their proofs are therefore cleaner by reason of their swiftness.

All good printers, perhaps, are not swifts, but it is safe to say that all swifts are good printers. It is only errorless type which is printable, and as a single error in a line renders the whole line worthless it is important that few errors be made. Speed in operating may be acquired by any indefatigable student. The proof-reader, however, must be reckoned with. Accuracy should be esteemed above mere speed. Speed will come with practice; accuracy only with painstaking endeavor.

There are some general rules which may be laid down as essential to the acquirement of speed in operating the keyboard of the Linotype. If the keys are to be operated without looking at the board, the hands must assume some fixed relation to the keys in order that the fingers may unhesitatingly and unerringly reach for the letters without the guidance of the eyes. Assuming that the location of the keys has been so memorized that they are indelibly impressed on the operator's mind, the hands must be placed so as to economize to the utmost the distance necessary to travel in order to

reach any key. Seated at the keyboard so that the lower-case side is directly before the operator, spread out both hands so as to cover entirely the lower-case keys. This should be the general position of the hands. This position will place the thumbs in control of the lower banks of keys, and they perform no slight portion of the work of operating. A system of fingering which will suit the long, lithe-fingered chap will be impossible to the stubby-fingered operator, so each must modify the general rules to suit his individual case. The object of both will be to avoid wide jumps of the hands in fingering the keys. Move the hands as little as you may. Stretch the hands out and spread the fingers over the keyboard. Use every finger you can control—all except the little finger, at any rate. A light, quick, but firm touch is the most effective. Now as to practice.

The best possible practice for the one ambitious to be a swift operator is repetition of certain words or phrases. By this method the entire attention can be concentrated on the finger motion, and when the proper combination has been determined, practise it over and over until it becomes mechanical. Wherever such combinations as sh, ch, in, etc., occur, make them with a single stroke of thumb or finger, sliding off one key on to the one below. In this manner practise on all ordinary prefixes and terminals and the common words. There should be no set rule as to which finger should strike a

certain key under all circumstances. The finger nearest to any key should be the one to use, and this will vary according to the needs of the following or the preceding words. In order to establish a system of fingering, however, and illustrate what is meant by economy of movement, it may be well to demonstrate the fingering of certain words. The accompanying diagrams are therefore submitted.

In these diagrams the letters on the fingers show the preferred method of fingering the word. Two or more letters connected by a ligature indicate that these should be struck with a wiping motion with the one finger given. These combinations should be practised over and over, and enlarged upon as proficiency is gained. Where double letters occur, the key is to be held down instead of making two strokes. In doing this, keep the rhythmic beat of the fingers without actually raising them from the key.

Bear in mind that repetition of words or sentences is of the utmost importance. To practise the word a half-dozen times is not sufficient. Practise it at first with the eyes on the keys, and as the location of the letters forming the word becomes fixed in the mind, look away and continue the practice. Keep wrist and fingers flexible, and do the moving with the fingers instead of the whole hand. Do not withdraw the hand or fingers after striking a key, and do not double up fingers not at the moment in use.

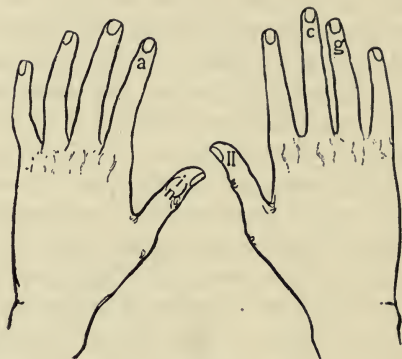

calling.

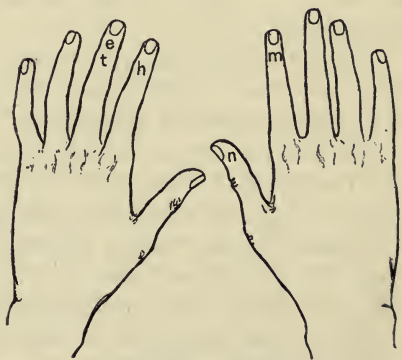

the-them-then.

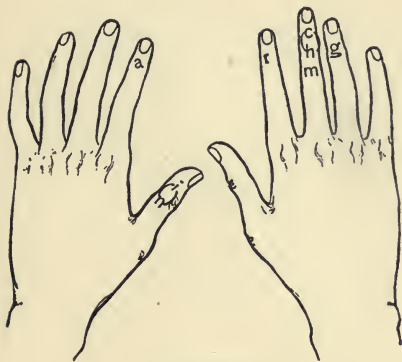

charming.

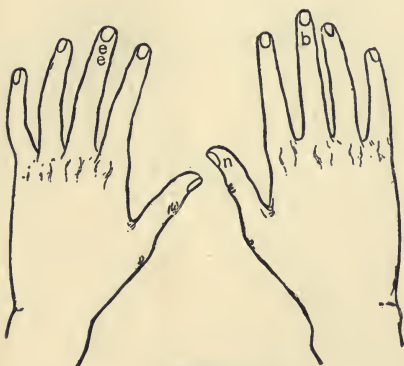

been.

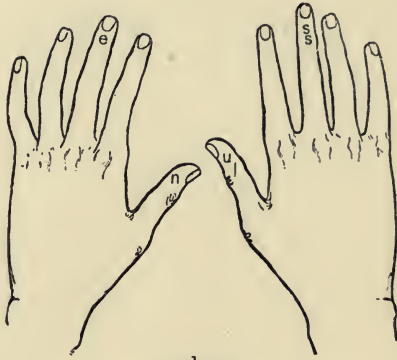

unless.

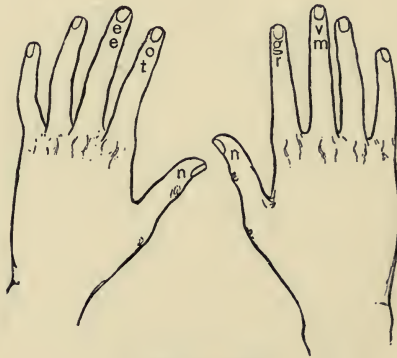

government.

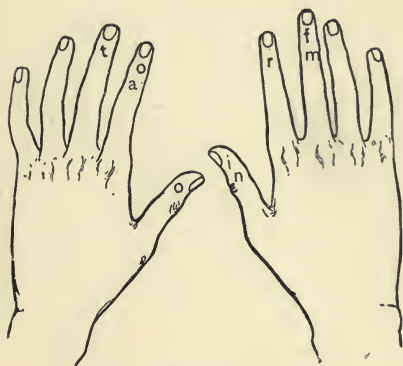

formation.

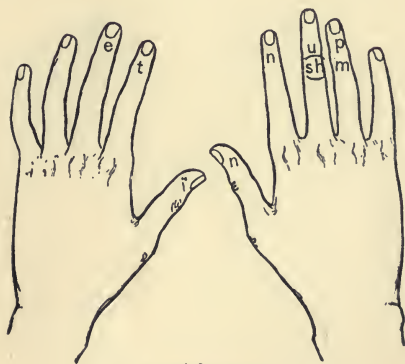

punishment.

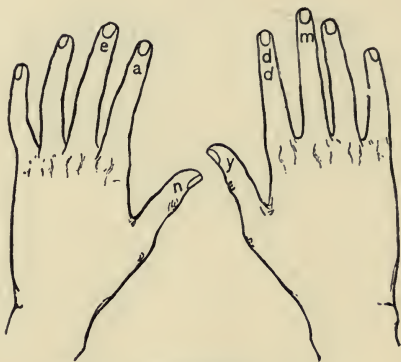

and—man—demand—many.

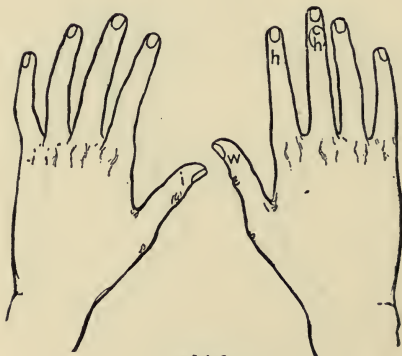

which.

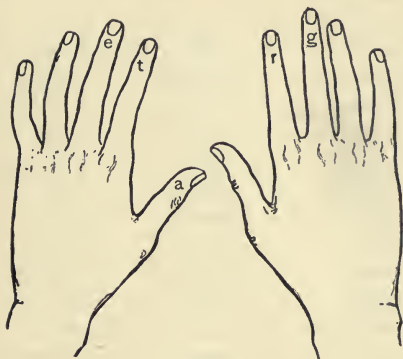

great.

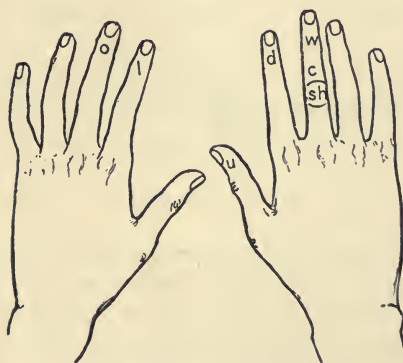

would—could—should.

The following list of words may be practised on with advantage :

making	each	retain
taking	toward	sustain
shaking	fresh	maintain
doing	mind	relation
striking	food	station
choking	blind	rarity
hardly	made	purity
truly	are	merrily
surely	bill	cheerily
kindly	chill	merely
friendly	mail	purely
much	meek	probably
such	willing	thoroughly
rush	week	usually
crush	there	fully
must	thus	willing
strike	always	number

A sentence which embraces every letter in the alphabet will afford good keyboard practice. Such a sentence as the following may be used :

The sleek brown fox jumped quickly over the lazy dog.

Use the en quad and a space-band after the period in sentences. The more space-bands in the line the less liability of hand-spacing. Carefully avoid oversetting the line ; it is better to send it in short and reset, using thin spaces with the space-bands

this time. The pump-stop will prevent short lines casting.

In quadding out lines use the en quad, em quad, and space-band alternately. The more space-bands in any line the less full it need be set. Operate the space-band with second or third finger of left hand. Do not strike two or more keys simultaneously. They almost certainly will clog or transpose before reaching the assembler. Speed the keyboard rollers to two hundred and seventy-five revolutions per minute and the machine to any number of lines per minute up to nine, provided you can "hang her up" at the speed, follow the system of fingering here expounded, and the proof-reader's pencil is the only thing that can stand in the way of any operator becoming a swift.



INDEX



HORACE GREELEY

INDEX

- Abbreviations, in algebra, combining of, 172; should be in roman and have no period, 185
- Accents, when required, often at inconvenient distance, 5; weight of, in font, 16; copy calling for, 22; proper placing of, 29; aid to correct distribution of, 95; in Century Dictionary, 232; in foreign languages, 233 (see also *note*); Greek, 236
- Advertisements, paging of, 146
- Algebra, tray cases serviceable for signs of, 31; braces used in, 55; composition of books of, 97; a difficult form of composition, 171; signs used in, 172; on the composition of, 172-188
- America, case in two parts favored in, 14 (*note*); machine patents granted in, 397. See also *United States*
- Antique, for running titles, 262; for cut-in notes, 280; for legend lines, 281
- Appendix, verbose extracts in, 138; paging of, 146; setting of, 147
- Arabic, one or more fonts of, 232 (*note*)
- Authors, proofs withheld by, 3 (*note*); type kept standing by delays of, 4; nicer attention to accents insisted on by modern, 30; agreements on style with, 76; paragraphing of copy by, 78; alterations by, 84, 85, 325; capricious taste of publishers and, 96; real sponsors of books, 108; type-work in subordination to intent of, 168; running titles usually determined by, 261; how make-up may be helped by, 276, 277; position of illustrations usually decided by, 284
- Baskerville, John, 239
- Bastard title, definition of, as distinguished from half-title, 130 (*note*)
- Bearers. See *Guards*
- Benzine, 84 (see also *note*), 94, 321, 322
- Bible, brief chapters of, 135; versification of, 136; close succession of chapters in, 268
- Bidpai Literature, Pedigree of, 226, 227, 228 (see also *note*)
- Binding. See *Book-binding*
- Blacklead, in electrotyping, 53
- Black-letter, use of, in title-pages, 112 (*note*), 126 (*note*); not suitable for chapter headings, 132; running titles in, 142, 262; spurs and angles of, 253; Flemish, 253; composition of, 282 (*note* 2)
- Blades, William, a most diligent searcher, 145 (*note*)
- Blocks, patent, 55
- Bodkins, description and use of, 45, 323 (see also *note*)
- Bodoni, Giambattista, safe leadership of, 110
- Bohemian. accents used in, 233
- Book-binding, adjustment of margins suitable for, 297-306, 332 (*note*); most approved method of

- sewing in, 333, 334; defects of side-stitching in, 334 (*note*); neat, 376; unworkmanlike, 378 (*note*); mean, 396
- Book-chases. See *Chases*
- Book-houses, sorts needed in, 2; supply of printing-material needed in fully equipped, 3, 4; petty fonts of display types seldom needed in, 29; large types and borders often required in, 32; petty cabinets not desirable for, 35; weight of leads required in, 60; making up in, 67; time-hands and piece-hands in, 75; stonework in American, 80; characters seldom found in ordinary, 232
- Books, types needed for composition of, 1, 2; printed from type, 73; from electrotype plates, 73; methods followed in production of, 76 *et seq.*; title-pages of, 111 *et seq.*; dedication, 127, 128; table of contents, 128, 129; table of illustrations, 129, 130; parts and half-titles, 130, 131; chapter headings, 131, 132; chapter synopsis, 132, 133; preface and introduction, 133, 134; without running title, 144, 145; Kelmscott, 159; one method of decorating, 161; decorations for, should be made by qualified artist, 163 (*note*); typography of, should agree with subject-matter, 167, 168; odd and plain types in, 168; with decoration, 168; ephemeral, 169 (*note*); copying best features of, 170; characters needed in mathematical, 172; recent, of good workmanship, 261; types for running titles of, 262; profusely annotated old, 280; sumptuous, 281; workmanship of well-printed, 288; locking up and correcting made-up pages of, 289; adjusting margins of, 297-306; gathering, folding, sewing, and trimming sections of, 332-337, 340 (see also *note* 2), 342, 362, 365, 366, 368, 375, 376, 388, 389; side-stitching never used for library, 334 (*note*); advertised descriptions of, 370 (*note*); schemes for sewed, 392, 396. See also *Pamphlets*
- Book-work, fractions, signs, and reference-marks in, 18; solid and leaded, 21; faces of brass rule most used in, 47; brass braces seldom used in, 55; leads for ordinary, 57; lengths of furniture rarely required in, 68; should receive two readings, 85; spacing and leading of, 88 *et seq.*; tables in good, 198; miscellaneous, 232; Flemish black-letter occasionally used for display lines in, 253; how to insure accurate register on, 292; adjusting margins in, 297-306; tools needed by stoneman for exact, 307; folding of sections in, 332-337. See also *Composition*
- Borders, large, often needed in book-houses, 32; brass rules of plain face now more needed than, 51; hair-line rule, 52-55; twisted and fantastic, 108; broad, 160; of type, 160; thin strips of, 165; overworked typographic, 165, 167; now provided by type-founders, 167; in the so-called Elzevir and in the Byzantine or Turkish style, 167; difficulty of locking up forms containing brass-rule, 315, 316
- Bottling, how to remedy, 313
- Box-fasteners, 31
- Braces, freakish placing of, in type cases, 11; sectional supplanted by solid, 12; weight of, in font, 16; cases with unequal compartments needed for, 38; brass, 55; used in algebra, 174, 180; French method of using, 205, 206; in genealogies and pedigrees, 225
- Brackets, in algebra, 173, 178, 179, 180, 185, 186
- Bruce, David, Jr., 255
- Bruce, George, 171
- Bruce Type Foundry, scheme formulated by, 16
- Bunsen burner, use of, 407
- Burr machine, 398
- Byzantine style, 167
- Cabinets, improved form of, 9, 10; for cuts, 33; for job cases, 35
- Capelli, Adriano, 234 (*note*)
- Capitals, increased supply of, sometimes needed, 2; arrangement of, in type cases, 11; weight of, in font, 16; in steady request, 18; proposed arrangement of lower case with, 19; case for lower-case, small capitals, and, 22; job cases for lower-case and, 28, 35; triple case for, 29; uniformity in use of, 77; spacing of, 90, 91; roman, of regular form, preferred for title-pages, 111, 112; for chapter headings, 131, 132; accented, 233 (see

- also *note*); roman or italic, for running titles, 262. See also *Letters* and *Small capitals*
- Capitals, small. See *Small capitals*
- Case-racks, too much room occupied by, 36; for display type, 36, 37; should be numbered, 37
- Case-rests. See *Cabinets* and *Stands*
- Cases, stands for supporting, 4 *et seq.*; for ordinary composition, 10 *et seq.*; in one piece, 14 (*note*); surface of, 14; accepted form of lower, 15; readjustment of boxes of, 17, 18; old-fashioned, 22; for lower-case, capital, and small-capital letters, 22; made for composition of *Century Dictionary*, 23-27; job, 28, 35; triple, 29; tray, 31, 32, 33, 38; great defect in, of old manufacture, 31; now made as strong as they are light, 31; combination of quarter, 33, 38; for quadrats and spaces, 34; for leads, 34; common form of quadrat, 35; for display type should be numbered, 37; for composition of Greek, Hebrew, and music, 38; for labor-saving rule, 49-52; disadvantage of shaking, after distribution, 101; for composition of algebra, 175, 176; for music composition, 219, 220-223; for composition of Greek, 237; for Hebrew, 245, 246; for German, 250, 251 (see also *note*)
- Catch-lines, in title-pages, 114 (see also *note*)
- Caxton, William, old Flemish black used by, 253
- Centennial Exposition, 402
- Century Dictionary, special stand made for composition of, 23-27; accents used in, 232
- Chapter headings, setting of, 131 (see also *note*), 132; on odd pages, 134, 135 (see also *note*); sinkage of, 255, 268
- Characters, insufficient provision of, 2; arrangement of, in type cases, 11 *et seq.*; new, 77; unusual, 95; algebraic, 175, 187; Greek, Hebrew, and German, 232. See also *Capitals*, *Letters*, and *Small capitals*
- Charts, genealogical, 228, 229
- Chase-bars, 55. See also *Cross-bars*
- Chase-racks, 67, 290, 330
- Chases, 2; forms of type in, 63; fitting of, with furniture, 78, 310; for electrotyping, 81, 318, 330, 343, 344; pages imposed in, 83; racks for, 289, 330; cast-iron and wrought-iron, 290, 291, 343, 344, 345 (*note*); twin, 292; shifting-bar or book-, 292-294; screw, 294; long and narrow, or heading-, 294; selection of, 306, 307, 316, 317, 343; exact register impossible with unsquared, 307 (see also *note*); how to prevent bowing of, 308, 309; how they may be strained or cracked, 314; gripper-edge of, 327; care of, 345 (*note*). See also *Cross-bars* and *Imposition*
- Circulars, publishers', 32
- Citations. See *Extracts* and *Quotations*
- Code, on style, 99
- Composing-machines. See the various qualifying names
- Composing-room, type cases most noticeable objects in, 4; importance of keeping materials accessible and in good order in, 5; how to secure orderly arrangement of, 35, 36; planning a, 57; use of imposing-stone in, 289
- Composing-rule, description and use of, 46, 100, 259, 323
- Composing-stick, description of, 44 (see also *note*); different styles of, 44, 45 (see also *note*); correct manner of holding, 98; proper method of emptying, 101, 102; adjustment of, to measure, 102, 103; for algebraic formulas, 182 (see also *note*), 187; should not be laid on face of form, 324
- Composition, types needed for different kinds of, 1, 2; when it can be economically done, 3 (see also *note*), 4; cases for ordinary, 10 *et seq.*; open, 21; of Greek, Hebrew, and music, 38; waved, triple, and ornamental rules not used in plain, 47; needless delay and trouble in, 54; made spongy by treble-leading, 62, 92, 262; by time-hands and piece-hands, 75; routine of plain, 75 *et seq.*; common fault of novice at, 86; solid and thin-leaded, 88; projecting kerns in electrotpe, 90; adjustment of blanks or white lines in, 91, 92; influence of type-setting machines on, 96, 97; aids to, 100; of title-pages, 111 *et seq.*; dedication, 127, 128; table of contents, 128, 129; table of illustrations, 129, 130; parts and half-titles, 130,

- 131; chapter headings, 131, 132; chapter synopsis, 132, 133; preface and introduction, 133, 134; appendix, 147; index, 147, 148; poetry, 148-151; algebra, 171-188; tables and table-work, 188-207; music, 207-225; genealogies and pedigrees, 225-230; older forms of troublesome, 230; Greek, 234-240; Hebrew, 241-247; German, 247-254; computation of space occupied by, 257, 258; maker-up responsible for justification of, 258; made square and solid in making up, 259, 260; how to amend fault in some kinds of, 275; cuts or narrow tables in, 282; locking up, 306-320; mechanical substitutes for hand, 397 *et seq.* See also *Type-setting*
- Compositors, material must exceed daily needs of, 3 (see also *note*), 4; working with insufficient light, 5; stands for supporting type cases of, 5 *et seq.*; hand-travel of, 14, 15; grouping of space boxes approved by, 27; helps to new, 29, 30, 37, 38; type-setting on piece by, 75 *et seq.*; effect of type-setting machines on employment of, 96, 97; reading of sticks by, 103, 104, 324; on setting of title-pages by, 112 *et seq.*; skill required by, for algebra, 171, 172; former difficulties of, on table-work, 188; music, 207, 208, 219, 224; casting off of music by, 216-218; on foreign languages, 231, 232, 233; pencilled Greek extracts bewildering to modern, 234; study of Greek alphabet of service to, 236; Hebrew cases used by American, 245, 246; on German, 254; correction of proofs by, 323-325; distribution of unusual sorts by, 329. See also *Job-printers* and *Printers*
- Contents, setting of table of, 128, 129
- Contractions. See *Abbreviations*
- Coptic, one or more fonts of, 232 (*note*)
- Copy, irregular or insufficient supply of, 3 (*note*); safe-keeping of, when out of use, 10; minor or extra sorts rarely called for by ordinary, 12; requiring roman and italic, accents and display letter, 22; preliminary examination of, 76, 77; short and long "takes" of, 77; methods of handling, 77 *et seq.*; for title-pages, 112, 118, 121; paragraphs and sections in, 137; for algebra, 187; recomposing a table from manuscript, 194 *et seq.*; music, 217; for genealogical charts, 229; in foreign languages, 231; in German, 254. See also *Manuscript*
- Counting-room, needs of, 79
- Cox machine, 400
- Cross-bars, 63, 291-294, 303, 307, 308, 314, 315, 339, 340 (*note* 1), 344, 345 (*note*), 347, 353, 363, 364, 369, 373, 375, 376, 378, 382, 385, 395. See also *Chase-bars* and *Chases*
- Cut-in notes. See *Notes*
- Cuts, half-tone, 32, 33; cabinet case for, 33; how to keep, in printing-office, 33 (*note*). See also *Engravings*, *Illustrations*, and *Photo-engravings*
- Cutting-machine, use of, 388
- Cylinder-presses, use of patent quoins on, 297; how to place forms on, 326, 327; place of points for, 363 (*note*)
- Danish, marked vowels of, 30, 233
- Dashes, freakish placing of, in type cases, 11; weight of, in font, 16; cases with unequal compartments needed for, 38; single, parallel, and double, 55; ornamental, 55; use of thin space on each side of, 89; spacing of, between short articles or paragraphs, 91, 92, 288; in title-pages, 125
- Dates, in title-pages, 123, 124
- Decoration, judicious and injudicious, 108, 109, 125; attempts at, by early printers, 159; should be designed by qualified artist, 163 (*note*); on a large scale, 164 (*note*); old-time typographic, 167; books with, 168; bad lessons in, 169 (*note*); hackneyed, 170. See also *Ornamentation*
- Dedication, setting of, 127, 128
- Designers, pen drawings of amateur, 169 (*note*)
- Devices, labor-saving, 2
- De Vinne, Theodore Low, dictionary stand and cases designed by, 23-27
- Diacritical marks. See *Accents*
- Dickinson, Samuel Nelson, 231
- Dictionaries, special stand and cases designed for, 23-27; side-headings of, 137; accents in, 232
- Dictionary, Century. See *Century Dictionary*
- Dictionary of the Art of Printing, 234 (*note*)

- Didot, Ambroise Firmin, safe leadership of, 110; genealogical chart in work by, 228 (*note*)
- Display, sizes of type useful for, 2; letters needed for, often at inconvenient distance, 5; copy calling for, 22; in title-pages, 115 *et seq.*; bold, 167. See also *Job-work*
- Distribution, hand-travel in, 15; aids to cleaner, 21; safeguards against reckless, 29, 30, 37, 38; correct method of, 93-95; set hours for, 100; disadvantage of shaking cases after, 101; standing galley reserved for, 327; of leads, quadrats, and unusual sorts, 328, 329; process of, in Mergenthaler machine, 422-424
- Dovetails, 63
- Drugulin, W., polyglot printing-house of, 232 (*note*)
- Dummies, use of, in printing, 346, 393, 394
- Electrotype guards. See *Guards*
- Electrotypers, furniture preferred by, 63, 73; hair-line rules objectionable to, 143 (*note*); experiences of, with forms, 307 (*note*); guards provided by, 318-320. See also *Finishers*
- Electrotypes. See *Plates*
- Electrotyping, rules unsuitable for, 53, 54; hair-line rules for, should have blunt angles and high shoulders, 53; chases for, 291, 343, 344; use of guards in, 318-320; preparing forms for, 366, 367, 387
- Elzevir style, so-called, 167
- Empire machine, 401
- England, case of two parts favored in, 14 (*note*); use of medieval initial letters in, 153; music published in, 208
- English, absence of accented letters in ordinary, 232
- Engravings, wood-, 140. See also *Cuts, Illustrations, and Photo-engravings*
- Essai sur la Typographie, 228 (*note*)
- Estienne, Pierre, 228 (*note*)
- Estienne family, genealogical chart of, 228 (*note*)
- Europe, printers of northern, 14 (*note*); machine patents granted in, 397
- Extracts, types for, 77; spacing of, in text, 91, 92, 255, 268, 287; leading of, 137; short, in text, 137; approved practice of setting, 138; new method of indicating, 138; verbose, in appendix, 138; within rules of hair-line face, 138; begun with plain two-line letter, 138; driving out or getting in, when making up, 287. See also *Quotations*
- Facs, French and English eighteenth-century, 165
- Figures, increased supply of, sometimes needed, 2; arrangement of, in type cases, 11, 12; reference-marks supplanted by superior, 12; weight of, in font, 16; tray cases for, 32; cases with unequal compartments needed for, 38; spacing of tables of, in text, 91, 92; complex tables of, 97; in display lines, 123, 124; old-style, 123, 136, 145; paging, 144-146, 149, 150, 261, 262; in algebra, 172, 173, 176, 177, 178; superior and inferior, 174, 176, 179, 185; index, 184; in tables, 191, 195 *et seq.*; use of arabic, in German, 252. See also *Numerals*
- Fingering, correct keyboard, 447 *et seq.*
- Finishers, plates in hands of, 74. See also *Electrotypers*
- Firmin-Didot. See *Didot*
- Flemish, accents used in, 233
- Folding-machines, different forms of, 332, 333, 343 (*note*), 359 (*note* 2), 362, 389-392
- Fonts, large and small, 1, 2; composition not economically done with small, 3 (see also *note*), 4; scheme for, 16, 17; need of many small, 35; music, 219; of many faces and sizes, 232. See also *Letters and Types*
- Foot-notes, types needed for, 1, 2; placing of, 99, 277, 278, 279; setting of, 139. See also *Notes*
- Foot-sticks. See *Side-sticks*
- Forms, table of signatures and folios for different, 272, 273; making front margins for eight-page, 303; making tall margins for sixteen-page, 304; locking up, 306-320; taking proofs of, 320, 321; cleaning, 321, 322 (see also *note*); inserting points in, 325, 326; printing of, on cylinder-presses, 326, 327; breaking up of, 327, 328; schemes of imposition grouped in four classes of, 335; rules controlling imposition of, 337, 338

- (see also *note*); adjusting margins of, for electrotyping, 366, 367. See also *Imposition*
- Formulas, algebraic, 176, 177, 178, 181-183, 185, 186, 187, 188
- Fournier, Pierre-Simon, 234 (*note*)
- Fractions, freakish placing of, in type cases, 11; rarely needed, 12; weight of, in font, 16; in book-work, 18; combining of, in algebra, 172, 176
- Frames. See *Stands*
- Franklin, Benjamin, 1
- French, copy in, 231; accents used in, 233
- Furniture, wood and metal, 2, 62, 63; old and new forms of, 5; chase, 63; orderly storage of, 64 *et seq.*, 289; metal preferable to wood, 70, 71, 316, 317; combination metal, 71, 72; for gutters of back margins, 256; how to prevent needless cutting of, 257; pages protected by stoneman with, 259; effect of moisture upon wooden, 288; proper distinguished from improper use of, 309, 310; retightening of quoins in forms with wooden, 318; guards of metal, 319; removal of, from forms, 327; when to select and put in place, 342 (*note*), 343; fitting new forms with, 345 (*note*), 395; shrinkage of, 352. See also *Side-sticks*
- Furniture-cabinet, 67 (see also *note*)-70 (see also *note*)
- Furniture-drawers, 64, 66, 68, 70, 289, 290
- Furniture-racks, 65, 66, 70, 71, 72
- Galley-racks, quadrat cases made to rest upon, 34; purpose of, 41; with swinging arms, 41; with fixed arms, 41; with inclined shelves, 42
- Galleys, 2; stands made with supports for, 7; broad standing and movable, 8; placed underneath cases, 10, 26; description and use of, 39; wood, brass, and slice, 39, 40, 290; description and purpose of standing, 42, 43; proving of, 80 *et seq.*; type read and corrected on, 256; of composed type, 257; materials for making up should be placed on small, 258; quarto, with low rim, preferred for making up, 258; justifying on, 324; standing, reserved for distribution, 327
- Gazetteers, side-headings of, 137
- Genealogies, composition of, 225-230
- German, copy in, 231; accents used in, 233; alphabet of, 247-249; cases for composition of, 250, 251 (see also *note*); double letters in, 250; umlaut over vowels in, 251; capitalization of, 251; division and compounding of words in, 251, 252; quotation-marks and arabic figures in, 252; characters of, 252, 253
- Germany, fantastic borders in fashion in, 108; medieval initial letters frequently used in, 153; use of roman character in, 253
- Goodson Graphotype, 402
- Gothic, legend lines in, 281
- Greek, cases for composition of, 38; aid to correct distribution of, 95; use of, in algebra, 173 (*note*); copy in, 231; breathings of, 233 (*note*), 236; alphabet of, 234, 235; working font of, 234 (see also *note*); accents of, 236; cases for composition of, 237; rules for placing accents in, 238; different faces of, 239
- Greeley, Horace, 463
- Gregory, St., 219
- Guards, electrotype, sectional cases for, 31; description and use of, 73, 74, 316, 318-320
- Gutters, 63, 64 (see also *note*), 71, 256, 257, 274, 310
- Half-diamond indentation. See *Indentation*
- Half-titles, setting of parts and, 130 (see also *note*), 131. See also *Titles and Title-pages*
- Hand-presses, taking proofs on, 320; presswork done on, 336, 337, 344 (*note*); usual place of points for, 363 (*note*)
- Hand-work, contrasted with machine-work, 96, 97; proper methods of, 97 *et seq.*
- Hanging indentation. See *Indentation*
- Harper, James, 75
- Head-bands, on use of, 159-167, 168
- Head-bolts, 63, 64, 71, 310, 347, 364
- Heading-chases. See *Chases*
- Headings. See *Chapter headings, Side-headings, and Subheadings*
- Hebrew, cases for composition of, 38; aid to correct distribution of, 95; copy in, 231; alphabet of, 241, 242; points as guides to pronunciation of, 242, 243; accents and Masoretic points or vowels

- of, 243, 244; Shevas used in, 245; read from right to left, 245, 293; cases for composition of, 245, 246; words in, cannot be divided, 247
- Hempel quoin, 296, 297
- Hints on Imposition (Williams's). lifting device described in, 291 (*note*)
- History of the Origin of Printing, 278 (*note*)
- Holy Scriptures. See *Bible*
- Houghton, Henry O., 111
- Hungarian, accents used in, 233
- Hyphens, use of thin space on each side of, 88; in German, 252; faulty use of, 276
- Iliad, Pickering's edition of, 239 (*note*)
- Illustrators, fifteenth-century, 159
- Illustrations, electrotyped, 32; furnishing of, 80, 81; text led down at side of, 90; relief of white needed by, 106; setting of table of, 129, 130; testing of, 140, 141; placing of, 141, 284-286, 287; of running titles, 264-267, 268, 269; placing of, in pages, 276, 277; legend lines of, 280-282 (see also *note* 1); of irregular shape, 283, 284; wood-blocking of electrotype, 288; moulding of, 318; scheme for printing, 361, 362. See also *Cuts*, *Engravings*, and *Photo-engravings*
- Image, Selwyn, Greek type designed by, 239, 240
- Imperial Printing House, Vienna, 232 (*note*)
- Imposing-stone, 2; dimensions of, 67; made-up pages on, 274; use of, in composing-room, 289; many sizes of, 289, 290; should be cleaned before pages are laid down, 306; flat side of quoins should rest upon, 311; types too tightly locked up spring from, 312, 313; correcting and justifying on, 324; preparatory work on, 325; fitting of chase-rack under, 330
- Imposing-table. See *Imposing-stone*
- Imposition, adjusting margins in, 297-306; locking up, 306-320; elementary principles of, 331-337; four pages in two forms and two chases, 337; four pages in one chase, 338; four pages in one chase, long way, 339; four pages in one chase, imposed from centre, 339; sixty-four pages in one chase, four sections of sixteen, 341; circular of two pages only, the print on first and third pages, 345; inset folio of twenty pages in ten forms, 346; legal folio of four pages, 347; legal folio of sixteen pages, imposed for insets, 348; eight pages in one form, music or oblong way, 348; eight pages in usual way, 349; eight pages imposed from centre, 349; eight pages in two sections of four, known as "two on," 349; eight-page forms in three chases, inset to make one section of twenty-four pages, 350; eight pages, two wide, four high, 351; eight pages for offcut of paper, 351; sixteen pages in two chases for one section, 351; sixteen pages, imposed from centre, 353; sixteen pages as usually laid, 353; sixteen pages as two sections of eight, 354; sixteen pages in two portions of eight for inset, 354; sixteen pages in two sections of twelve and four, 355; sixteen pages in three sections, one of eight and two of four pages, 356; sixteen oblong pages, music way, one section, 356; thirty-two pages in two chases, to fold as one section, 357; thirty-two pages in two forms, separately folded and inset as one section, 358; thirty-two pages as four sections of eight pages each, 359; ninety-six pages in one chase, six sections of sixteen, 360; one hundred and twenty-eight pages in one chase, eight sections of sixteen, 361; twelve pages in one chase, 363; twenty-four pages in two chases, as one section, 365; twelve pages in one chase, triplicates of four pages, 368; twelve pages of oblong shape, no inset, central imposition, 369; twenty-four pages, oblong shape, inset of eight, 370; twenty-four pages in one chase, with offcut of eight inset as one section, 371; twenty-four pages in one chase, two sections of twelve, offcuts separately folded and inset, 371; twenty-four pages on square sheet, with offcut of eight inset as one section, 372; twenty-four pages on square shape of sheet, two sections of twelve, 373; forty-eight pages in one chase, three sections

- of sixteen, square shape of paper, 374; seventy-two pages in one chase, six sections of twelve, 376; eighteen pages in one chase, for one section, 377; eighteenth fold of sixteen pages only, one leaf cancelled, 379; thirty-six pages in two chases, three sections of twelve, 380; seventy-two pages in one chase, three sections of twenty-four, 381; twenty pages in one chase as one section, 382; twenty pages in one chase as one section without transposition, 383; forty pages in one chase, one section, inset of eight, 384; six-page leaflets in strip one page high, 385; ten-page leaflet, two pages high, 386; eight pages in quadruplicate, or "four on," 387; study of, made needlessly repelling, 396
- Imprint, black-letter not suitable for, 112 (*note*); broadest blank above, in title-pages, 114
- Indentation, use and omission of, 92, 93, 104, 105; half-diamond and hanging, in title-pages, 127; in chapter headings, 132; of synopsis, 133; of index, 147; of poetry, 149, 150; half-diamond, for legends, 281
- Index, for cuts, 33; paging of, 146; setting of, 147, 148
- Initials, plain, 2; out of place in title-pages, 120, 125; on use of, 151-159, 160, 161, 163, 167, 168
- Ink, removal of, from face of type, 321, 322 (see also *note*); tends to collect at ends of inking-rollers, 339 (*note*)
- Ink-table, 81
- Insets. See *Imposition*
- Introduction, setting of, 133, 134
- Irish, alphabet of, 233 (*note*)
- Italian, copy in, 231; accents used in, 233
- Italic, increased supply of, sometimes needed, 2; often, when required, at inconvenient distance, 5; weight of, in font, 16; copy requiring two or more sizes of, 22; accent case for, 30; uniformity in use of, 77; lower-case of, tolerated style for title-pages, 111; for long dedication, 128; for long synopsis, 133; for preface, 133; for subheadings, 135, 136; for side-headings, 136; occasionally selected for poetry, 138; unsuitable for side-notes, 139; running titles in lower-case and in capitals of, 142; use of, in algebra, 173 (see also *note*); for inferior letters, or subscripts, 184; avoided in German, 252; different sizes and faces of, for running titles, 262, 263; unsuitable for side-notes, 279; legend lines in, 281
- Jacobi, Charles T., treatise of, on printing, 14 (*note*)
- Jacobs, Joseph, 228 (*note*)
- Job-printers, special cases provided for, 35; composing-rules of, usually of brass, 46; very thin spaces used by, 87. See also *Compositors* and *Printers*
- Job-stick. See *Composing-stick*
- Job-work, furniture-rack devised for, 70; certain kinds of, 167; locking up and correcting made-up pages of, 289. See also *Display*
- Johnson Tachytype, 402
- Justification, facilities for, 15; spaces repeatedly changed in, 21; of algebraic work, 34; slight unevenness in, 55; importance of exact, 86 (see also *note*), 87, 306, 316, 317; time-wasting, 171; by gauges, 193, 194; of genealogical charts, 228; mischiefs produced by loose or careless, 312, 316, 317. See also *Spacing*
- Kelmscott books, 159. See also *Morris, William*
- Keyboard, correct fingering of, 447 *et seq.*
- Languages, accents and signs required in foreign, 2
- Lanston machine, 402
- Latin, copy in, 231
- Law cases, 1
- Lead-cutters, 58, 59
- Leaders, weight of, in font, 16; tray cases for, 31, 32; cases with unequal compartments needed for, 38
- Leading, spacing and, 88 *et seq.*
- Lead-rack, new form of, 60, 61
- Leads, 2; case for, 34; high and low, 35; cases with unequal compartments needed for, 38; description, use, and sizes of, 56, 57 (see also *notes*); different methods of keeping, 57-59, 61; should be ordered with system, 60, 91;

- weight of, required in book-house, 60; should never be pieced, 61, 62; addition or withdrawal of, 253; of different thicknesses, 253; difficulty of locking up forms full of thin, 315, 316
- Leaflets, description and imposition of, 385, 386
- Letter-boards, racks for stowing, 43; should have raised rim at extreme end, 43; pages on, 84; type for distribution on, 93, 327, 328
- Letterpress, rules most useful for, 52, 53; low leads used for, 56; full form of, 257
- Letters, small fonts of two-line capital, 2; spaces furnished with font of, 15, 16; weight of, in font, 16; double, 19; spacing of capital, 90; dense huddling of capital, 106; uncouth, 107 (see also *note*); pinched, 120; condensed, for cut-in notes, 139; initial, 151-159; in algebra, 172, 173; superior and inferior, 173 (*note*), 174, 176, 184. See also *Capitals, Characters, Small capitals, and Types*
- Linotype, Mergenthaler, 403 *et seq.*
- Linotype operator, how to become an expert, 426, 427, 433, 445 *et seq.*
- Literature, Bidpai, Pedigree of, 226, 227, 228 (see also *note*)
- Locking up, how to acquire skill in, 306-320
- London, music published in, 208
- Lower-case, weight and proportion of, in font, 16, 17; proposed case for capitals and, 19; arrangement of case for capitals, small capitals, and, 22; job cases for capitals and, 28; spacing of capitals and, 90; table of contents in roman, 128; for chapter synopsis, 133; cut-in notes in small sizes of, 139; running titles in italic, 142, 262, 263; small-sized, for running titles, 143; roman, for cut-in notes, 280; legend lines in roman and in italic, 281
- Lye, boiling, 84 (*note*), 94, 322
- Machines. See the various qualifying names
- Machine-work, contrasted with hand-work, 96, 97
- Mackellar, Thomas, 289
- Macmillan Company, 239
- McMillan machine, 401
- Magazines, subheadings of, 107; side-stitching of, 334 (*note*), 392; folding-machines for, 390
- Make-up. See *Making up*
- Maker-up, compact arrangement of cases an advantage to, 10; duties of, 78 *et seq.*, 99, 132, 141, 146, 260, 262, 269, 274, 277, 280, 286, 330; should have a diagram, 255, 299, 302, 342 (*note*); gauge used by, 256; measuring and marking off by, 257; responsible for justification of composition, 258; should have ready access to needed materials, 258; copy and proof should be continually before, 260; amendment of fault by, 275
- Making up, not paid for by piece, 76; methods of, 78 *et seq.*; diagram needed in, 255; gauge for, 256; quarto galley with low rim preferred for, 258; tying up page in, 258, 259; duties included in, 260; of chapters, 268, 269 (see also *note*); one of the modern methods of, 283; of pages in two colors, 288; a study without end, 288; correct stone-work dependent on exact, 306; search for faults in, 317
- Mallet, description and use of, 295, 296, 297; improper use of, 311, 312, 313; first strokes of, should be light, 315; should not be laid on face of form, 324
- Mannerisms, recent, in typography, 104 *et seq.*
- Manuel Typographique, 234 (*note*)
- Manuscript, tables in, 202; setting genealogical charts from, 228, 229; in Greek, 234; in German, 254. See also *Copy*
- Marchand, Prosper, 278 (*note*)
- Marginal sheet. See *Pattern sheet*
- Margins, adjustment of, 297-306, 332 (*note*), 342 (*note*), 345 (*note*), 347, 348, 364, 366, 367, 385, 386, 392, 394, 395
- Matrices, linotype, 404 *et seq.*; treatment of, 429, 430
- Mechanic Exercises, 14 (*note*)
- Melting-pot, treatment of, 428, 429, 433, 434
- Mergenthaler Linotype machine, 403 *et seq.*; learning to operate, 426, 427; management of, 427, 428; temperature of metal, 428, 429; treatment of matrices, 429, 430; treatment of spaces or justifiers, 431, 432; cleaning, 432, 433; the melting-pot, 433, 434; the mould, 435; the mould disk, 435, 436; cau-

- tionary remarks, 445, 446; correct keyboard fingering, 447 *et seq.*
- Mergenthaler, Ottmar, 397
- Mitring, value of time given to, 48; method of, 49, 50; thin rule not suitable for, 54, 55; testing accuracy of, 316
- Mitring-machines, 48, 49, 188
- Monotype, for running titles, 262
- Monotype. See *Lanston machine*
- Morris, William, disciples of, 105; title-page of, 125; odd initials designed by, 159; composition in style of, 282 (*note* 2)
- Motto, placing of, in title-pages, 124, 125 (see also *note*); improved method of setting, 287
- Mould, treatment of, 435, 436
- Moulding, use of guards or bearers in, 318-320
- Moulding-press, pressure of, 344
- Moxon, Joseph, upper case shown by, 14 (*note*)
- Munsell, Joel, 331
- Music, cases for, 38; setting of books of, 97; on the composition of, 207-225; imposition of pages of, 348
- National Printing House, Paris, 232 (*note*)
- Newspapers, weekly, 1; form of composing-stick preferred on, 44, 45; imposing-stone for making up, 289; twin chases preferred for ordinary weekly, 291, 292; locking up, 317
- Notes, types for, 77; side- and cut-in, 90, 97, 139, 140, 279, 280; leading of, 137; setting of, 139, 140; long, 276, 277, 278; placing of, 278, 279. See also *Foot-notes* and *Side-notes*
- Numerals, roman, in lines of capitals, 123, 124; for parts and half-titles, 130, 131; paging with, 134. See also *Figures*
- Odyssey, Pickering's edition of, 239 (*note*)
- Offcuts. See *Imposition*
- Old English. See *Black-letter*
- Old-style, complete series of, 2
- Operator, how to become an expert, 96, 426, 427, 433, 445 *et seq.*
- Oriental languages, fonts of, 232 (*note*)
- Ornamentation, unwise fondness for, 108, 109; profuse, 169 (see also *note*). See also *Decoration*
- Outsets. See *Imposition*
- Paige machine, 398
- Pamphlets, printed from type, 73; from electrotype plates, 73; without running title, 144, 145; advertising, 169 (*note*); of one or two sheets, 257; new styles of folding-machines for, 333; side-stitching of, 334 (*note*), 375, 378 (*note*), 392; centre-stitching of, 340 (*note* 2); single-sheet, 377; cheap, 381, 383, 384, 396; small, 386-388. See also *Books*
- Panels, title-pages in, 108, 126
- Paper, sizes of, used in book-work, 297-306, 370 (*note*), 372, 374, 377 (see also *note*), 383, 394; for proofs, 323; large sizes and strange shapes of, 331; how to utilize offcuts of, 351; how to prevent or lessen buckling of, 355, 357; hand-made, 364; smooth-edged, 364
- Paragraphs, print made more readable by, 78; the spacing of dashes between, 92; the indentation of, 92, 93; numbered or lettered, 136; the overrunning of, 324 (see also *note*)
- Parentheses, in algebra, 173, 178, 179, 180, 185, 186
- Pattern sheet, for adjusting margins, 297-306, 342 (*note*)
- Pedigree of Bidpai Literature, 226, 227, 228 (see also *note*)
- Pedigrees, composition of, 225-230
- Periodicals. See *Magazines*
- Photo-engravings, paper for, 140 (*note*); typography and, 230; halftone, 318; cleaning of, 322 (see also *note*). See also *Cuts*, *Engravings*, and *Illustrations*
- Pi, making of, 104
- Pickering, William, safe leadership of, 110; edition of *Iliad* and *Odyssey* by, 239 (*note*)
- Piece-fractions, in algebra, 174
- Piece-hands, composition done by, 75, 76
- Planer, description and use of, 295; proper distinguished from improper use of, 311-313, 315, 317
- Plantin, Christopher, large initials of, 158
- Plates, electrotype, 53, 54, 55; pamphlets and books printed from, 73; etched by photo-engraving process, 140, 141; type off its feet a cause of faulty, 260; uneven electrotype, 306; use of guards in moulding, 318-320; adjusting margins for, 366, 367

- Poetry, setting of, 148-151; making up of, 286
- Points, increased supply of, sometimes needed, 2; arrangement of, in type cases, 11, 12; boxes for, 15; weight of, in font, 16; should be in groups in lower case, 19
- Points, in presswork, 325, 326, 340 (*note* 1), 363 (*note*), 390, 391
- Point system, type bodies measured by, 1, 2, 171; brass rules rolled to conform to, 47, 171; value of, in algebraic composition, 181
- Polhemus, John, double stand designed by, 7-9, 10
- Polish, accents used in, 233
- Porson, Richard, Greek type designed by, 239, 240
- Portuguese, accents used in, 233
- Preface, setting of, 133, 134
- Press, moulding, 73, 74
- Pressmen, not always responsible for imperfect printing of brass rules, 54; aid to, in making ready, 87; hair-line rules objectionable to, 143 (*note*); how to aid, in making register, 288; margins regulated by, 302, 345 (*note*); preparing forms for, 308, 309; treatment of forms by careful, 315 (*note*), 318; advantages of half-sheet work to, 337 (*note*); use of dummy as guide by, 346
- Press-room, needs of, 79
- Presswork, needless delay and trouble in, 54; preparing form for, 315 (*note*); use of points in, 325, 326, 340 (*note* 1), 363 (*note*), 390, 391; sheetwise, 336, 337 (see also *note*); half-sheet, 337 (*note*), 342; how to save extra, 355
- Print, use of paragraphs in, 78
- Printers, master, 3; of northern Europe, 14 (*note*); names used by, to designate brass rules, 47; their contracts with publishers, 75, 76; undervaluation by, 80; the methods of early, 127; some attempts at decoration by early, 159; the fads made by French and English, 165; the hackneyed decorations of, 170; schemes of imposition from the grammars of, 331. See also *Compositors* and *Job-printers*
- Printing, proper equipment for, 1, 2; rude types that deform, 108; masterpieces of, 168; adjustment of margins in, 297-306; locking up forms for, 306-320; sheetwise, 336, 337 (see also *note*). See also *Typography*
- Printing-houses, equipment of, 1 *et seq.*; supply of type must largely exceed demand in, 3; cabinet case for cuts, with index, needed in, 33; many faces of roman types provided by, 96; style code of, 99; characters needed for miscellaneous book-work in, 232; making up in, 256 (see also *note*); adjustment of margins in, 297-306
- Printing-machines. See *Printing-presses*
- Printing-presses, pressure of, 54; chases made to suit, 290; chases used as substitute for furniture on bed of, 294; quoins loosened by jarring of, 318; rotary, 332, 352, 362
- Prints, tipping on of, 334 (*note*)
- Proof-paper, 81, 82
- Proof-planer, 83, 295; taking proofs with, 320, 321
- Proof-press, 82
- Proof-readers, corrections by, 76, 83; copy and proof passed to, 80, 321; proof returned to compositors by, 83, 323; other duties of, 84; second reading by, 84, 85; revising and querying by, 324, 325; dummy of service to, 346; reckoning with, on linotypes, 449, 459
- Proof-reading, not paid by piece, 76
- Proofs, taking and correction of, 320-327
- Propaganda Fide, Rome, 232 (*note*)
- Publishers, contracts of, with employing printers, 75, 76; undervaluation by, 80; changes in proof by, 85; capricious taste of authors and, 96; real sponsors of books, 108; roman capitals preferred for title-pages by, 111; ornamental types in running titles not acceptable to, 262; instructions from, concerning margins, 298, 300, 301
- Punctuation, in type-setting, 99
- Quadrats, increased supply of, sometimes needed, 2; arrangement of, in type cases, 11, 12; weight of, in font, 16, 20; irregular use of large, 21; tray cases for, 32; case for spaces and, 34; common form of case for, 35; preferred for electrotyping, 73, 74; preferable to leads for blanks, 92, 262; of different bodies, 258; with nicks, 259; use of, to make form solid, 316;

- best electrotype plates made from types set with high, 319. Abbreviated *Quads*
- Quoins, 63, 64, 293 *et seq.*; patent, 296, 297, 313, 317, 318; selection of, 306; properly distinguished from improper use of, 309, 311; providing even resistance to pressure of, 313, 344; tightening of, 314, 315; advantage of patent over wood, 316; slackening of, 317; retightening of, 318; removal of, from forms, 327
- Quotation-marks, uniformity in use of, 77; for short extracts or quotations in text, 137; old fashion of using, 137, 138; single, 150; placing of, 150; in German, 252
- Quotations, forms of metal furniture, 72, 73, 258, 316
- Quotations, or extracts, short, in text, 137; long, 286; driving out or getting in, when making up, 287; improved method of setting, 287
- Racks, 2, 6, 7, 10; availability of sorts in, 18, 19; with supports, 23, 26; for galleys, 34; for leads, 34; job cases fitted to, 35; under standing galleys, 43; for chases, 289
- Readers. See *Proof-readers*
- Reading-room, needs of, 79. See also *Proof-readers* and *Proof-reading*
- Reference-marks, freakish placing of, in type cases, 11; supplanted by superior figures, 12; weight of, in font, 16; in book-work, 18; for long notes, 276; of notes should correspond to those in text, 278
- Register, how to insure accurate, 292, 325, 326, 344, 360, 367, 391, 392; makeshift aid to exact, 307; shrinkage of furniture an obstacle to, 352
- Reglet-case, labor-saving, 66, 67
- Reglet-rack, 67
- Reglets, 63, 65, 67, 68, 297
- Reprints, plain, 1; strict, 83, 276
- Revisers, method followed by, 83, 325
- Rollers, how to keep, 323; tendency of ink to collect at ends of, 339 (*note*)
- Roman, variations from standard of modern, 2; copy requiring two or more sizes of, 22; accent case for, 30; many faces of, needed by large printing-houses, 96; lower-case of, tolerated style for title-pages, 111; table of contents in lower-case of, 128; capitals of, for running titles, 142; use of, in algebra, 173 (*note*); different sizes and faces of, for running titles, 262; legend lines in, 281
- Rooker, Thomas N., case invented by, 15, 23
- Rule. See *Composing-rule*
- Rules, brass, 2; tray cases used for, 31, 32; case of four sections for, 34, 35; cases with unequal compartments needed for, 38; usually furnished in strips two feet long, 46; rolled to conform to bodies of point system, 47, 171; names used by printers to designate, 47; faces of, most used in book-work, 47; bevelled or flat-faced, 47, 53; mitring and proper joining of, 48; labor-saving, 48, 49, 54, 188; cutting and testing of, 49; cases for labor-saving, 49-52; plain faces of, now more needed than flowers or borders of type-metal, 51; should be bought from same foundry, 52; for letterpress work, 52, 53; in electrotyping, 53, 54; in composition and presswork, 54; made of type-metal, 55; uneven justification prevents joining of, 87; panels of, 108, 126, 169 (*note*); parallel or double, as head-bands, 165; combining of, in algebra, 172, 174, 175 (see also *note*); use of, in tables, 190 *et seq.*; sometimes used for bars in music composition, 218; in genealogies and pedigrees, 225; of graduated length, 258; cuts surrounded by, 285; difficulty of locking up forms containing, 315, 316; use of bits of flat-faced, as collating-marks, 389
- Rumanian, accents used in, 233 (*note*)
- Ruskin, John, on use of black and white, 106
- Russian, one or more fonts of, 232 (*note*)
- Sanskrit, one or more fonts of, 232 (*note*)
- Savage, William, 234 (*note*)
- Saxon, alphabet of, 233 (*note*)
- Schemes. See *Imposition*
- School-books, long and short accents used in, 30
- Scriptures, Holy. See *Bible*
- Sections, cutting, folding, gather-

- ing, and sewing of, in book-work, 332-337, 340 (see also *note* 2), 342, 362, 365, 366, 368, 375, 376, 385, 386-390, 393, 396. See also *Imposition Sheet*. See *Pattern sheet*
- Shooting-sticks, 87, 290, 295, 296, 297, 311, 315, 324
- Side-headings, types for, 2, 136, 137; setting of, 136, 137
- Side-notes, types needed for, 1, 2, 139; setting of, 139; placing of, 279; type and measure of, 279; abbreviations, etc., in, 279. See also *Notes*
- Side-sticks, 63, 64, 292, 295, 296, 306, 309, 310, 311, 313, 316, 317, 344. See also *Furniture*
- Signatures, use of, as guides to book-binders, 269-271; table of, 272, 273; at tail of sheet, 346. See also *Imposition*
- Signs, in book-work, 18; proper placing of astronomical and other, 29; tray cases used for, 31; aid to correct distribution of, 95; algebraic, 172, 173, 175, 176, 177, 178, 183, 184, 185, 186; music, 207
- Simplex machine, 400, 401
- Slitters, description and adjustment of, 391, 392
- Slugs, cutting of, 59; nonpareil and thicker, 62; linotype, 403, 405, 408, 422, 424, 425
- Small capitals, types without, 14 (*note*); weight of, in fount, 16; discarded in many books and newspapers, 18; case for lower-case, capitals, and, 22; line of capitals and, not pleasing in title-page, 120; for dedication, 127; for table of contents, 128; for chapter synopsis, 132; for subheadings, 135, 136; for side-headings, 136; for running titles, 142, 262, 263; for legend lines, 280, 281. See also *Capitals and Letters*
- Smashing-machine, use of, 388
- Sorts, orders for, 2; minor, 12; extra, 12, 13; scheme of, in fount, 16, 17; weight of lower-case, 20; proper placing of minor, 29; small cases for orderly keeping of irregular, 33; additional, 76, 77 (see also *note*); distribution of unusual, 328; treatment of, when in limited supply, 329
- Southward, John, treatise of, on practical printing, 14 (*note*)
- Space-rules, 56
- Spaces, arrangement of, in type cases, 11, 12; boxes for holding, 15; most needed, 16; weight of, in fount, 16, 20; grouping of boxes for, 27, 87; case for quadrats and, 34; best electrotype plates made from types set with high, 319; justifying, 324; linotype, 404 *et seq.*; treatment of linotype, 431, 432
- Spacing, facilities for even, 15; even, 21; and leading, 88 *et seq.*; of poetry, 148; of algebra, 171, 176; prevention of uneven, 284. See also *Justification*
- Spanish, copy in, 231; accents used in, 233
- Specimen-books, type-founders', 156, 159
- Square, use of, in stone-work, 307, 315
- Stands, for supporting type cases, 4 *et seq.*; availability of sorts in racks under, 18, 19; old-fashioned, 22; made for composition of Century Dictionary, 23-27
- Stephens. See *Estienne*
- Stereotyping, chases for, 291
- Sticks. See *Composing-stick*, *Shooting-sticks*, and *Side-sticks*
- Stone. See *Imposing-stone*
- Stoneman, adjustment of margins by, 297-306, 342 (*note*), 345 (*note*); square and straight-edge needed by, 307; should lock up type continuously and slowly, 315; form with mitred brass-rule borders needs extra care by, 316; effect of non-use of electrotype guards by, 319; cleaning of type by, 321, 322; clearing away of dead matter by, 327-330; use of dummy as guide for, 346
- Stone-work, not paid for by piece, 76; in American book-houses, 80; adjustment of margins, 297-306; locking up, 306-320. See also *Imposition*
- Straight-edge, use of, in stone-work, 307, 315; trimming proofs with, 321
- Subheadings, types for, 2, 77, 135, 136, 255; in panels, 108; setting of, 135, 136; of prominence, 167; driving out or getting in, when making up, 287
- Subscripts, in algebra, 184, 185
- Swedish, marked vowels of, 30, 233
- "Swift," how to become a, 447 *et seq.*
- Synopsis, should not run over on

- following page, 131 (*note*); setting of, 132, 133
- Syriac, one or more fonts of, 232 (*note*)
- System. See *Point system*
- Tables, rules most useful for, 52, 53; types for, 77; spacing of, in text, 91, 92, 282; complex, 97; of contents, 128, 129; of illustrations, 129, 130; on the composition of, 188-207; of irregular size, 276, 277; of full, broad measure, 285, 286; of signatures and folios for different forms, 272, 273; locking up forms containing, 315, 316
- Tail-pieces, on the use of, 159 *et seq.*
- Text, type bodies for larger sizes of, 2; led down at side of illustrations, 90; spacing of extracts and tables in, 91, 92; leading of, 137; inclosed with notes at top, side, and foot, 280
- Thomas, Isaiah, 39
- Thorne machine, 398
- Time-hands, composition done by, 75, 76; distribution by, 328, 329
- Time-tables, crowded setting of, 198, 200
- Title-pages, two-line capital letters for, 2; borders needed for composition of, 32; general effect of, 91; judicious decoration of, 108; roman capitals of regular form preferred for, 111, 112; on the setting of, 112 *et seq.*; filled with flourishes or divided into panels, 169 (*note*). See also *Half-titles*
- Titles. See *Title-pages*
- Titles, running, 142-144, 149, 255, 258, 260-269
- Treadle-presses, small forms on, 386
- Treatises, accents and signs required in scientific, 2; on law, theology, or science, 167; on algebra, 172, 175; accents in elocutionary, 232
- Turkish, borders in style known as, 167; one or more fonts of, 232 (*note*)
- Tweezers, description and use of, 46, 323 (see also *note*)
- Type-casting machines. See *Lanston and Mergenthaler*
- Type-closet, proper method of storing type in, 328, 329
- Type-founders, schemes of, not exactly alike, 16 (*note* 1); sectional cases furnished by, 31; brass rules designated by arbitrary numbers of, 47; labor-saving rule furnished by, 48, 49; guards provided by, 73, 74; uncouth letters of, 107 (see also *note*); old-style figures remodelled by, 145; Morris's odd initials reproduced by American, 159; engraved head-bands of, 164; borders now provided by, 167; decorations of, 169 (*note*); algebraic signs furnished by, 172; music fonts of American, 219; accents furnished by American, 233; German, 253
- Type-foundries, orders for "sorts" from, 2; old-established English, 233 (*note*)
- Type-metal, flowers and borders of, 51; rules made of, 55; furniture of, 62; electrotype guards made from, 318
- Type-racks. See *Racks*
- Types, fonts of, for all kinds of book composition, 1, 2; supply of, must exceed daily needs of compositors, 3 (see also *note*), 4; stands for supporting cases of, 4 *et seq.*; without small capitals, 14 (*note*); analysis of font of, 16, 17; petty fonts of display, 29; for title-pages and publishers' circulars, 32, 111 *et seq.*; need of many small fonts of display, 35; similar styles of, to be grouped together, 35; case-racks for display, 36, 37; large and heavy forms of, 64; pamphlets and books printed from, 73; self-spacing, 87; justification of large, 87; spacing and leading of, 88 *et seq.*; correct method of setting, 97 *et seq.*; over-wide spacing of single, 107; condensed, in title-pages, 115, 120; for dedication, 127, 128; for table of contents, 128, 129; for parts and half-titles, 130, 131; for chapter headings, 131, 132; for chapter synopsis, 132, 133; for preface and introduction, 133, 134; for subheadings, 135, 136; for side-headings, 136, 137; for notes, 139, 140; for appendix, 147; for index, 147, 148; subheadings, rules, or propositions in bold, 167; odd, 168; plain, 168; eccentric, 169; cast upon irregular and un-matable bodies, 171; made on point system, 171; music, 207, 208; diamond and excelsior music, 225; Greek, 234-240; Hebrew, 241-247; German, 247-253; for running titles and subheadings, 255; galleys of composed, 257; made

- up off their feet, 259, 260; for running titles, 262; should not be made up while wet or even damp, 288; locking up composed, 290, 291 (see also *note*), 292, 306-320; bottled, 313; cleaning of, 321, 322; distribution and storage of dead, 327-330; furniture must be accommodated to chase and, 395. See also *Antique, Capitals, Gothic, Initials, Italic, Letters, Lower-case, Roman, and Small capitals*
- Type-setters. See *Compositors, Job-printers, and Printers*
- Type-setting, regulating price of, 75, 76; literary side of, 76 (*note*); punctuation in, 99; close-spaced and solid, 105, 106; tables require more skill than plain, 189; genealogical charts unlike all other forms of, 228. See also *Composition*
- Type-setting machines, development of, 96, 397 *et seq.* See also the various qualifying names
- Typography, recent mannerisms in, 104 *et seq.*; reformers of, 110; a novelty of reformed, 145 (*note*);
- of books should agree with subject-matter, 167; of good editions should be studied, 170; photo-engraving and, 230. See also *Printing*
- United States, working in companionship no longer practised in, 80. See also *America*
- University Press, Oxford, England, 232 (*note*)
- Vinculum, in algebra, 183, 184
- Wax, moulding, 53, 73, 74, 318, 319
- Welsh, accents used in, 233
- Westcott, C. S., machine invented by, 402
- Whittingham, Charles, safe leadership of, 110
- Willems, Alphonse, 228 (*note*)
- Williams, T. B., device of, to aid in lifting large forms of type, 291 (*note*)
- Woodcuts. See *Cuts, Engravings, and Illustrations*
- Writers. See *Authors*



